

Short-Form catalogue 2025

COMPLETE RANGE OF SOLUTIONS FOR ELECTRICAL ENERGY EFFICIENCY



Technology development to offer products and comprehensive solutions to the market of electric power efficiency and electric mobility.



We create and develop new ways of managing electric power, tracing possible paths to a more efficient world.



We respond to energy needs, reducing their environmental impact. Committed to our own future.



We offer comprehensive solutions that allow for the optimisation of energy consumption.



Tailor-made and customised service. We treat your concerns as ours.

From 1973

- 2017. Technology for energy efficiency.
-
- 1992. Energy control technology.
-
- 1984. Technology for energy saving.
-
- 1982. Rational use of electric power



CIRCUITOR headquarters in Viladecavalls, Barcelona.

Present in all sectors

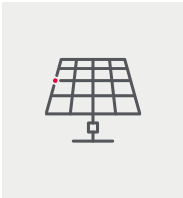

Photovoltaic facilities

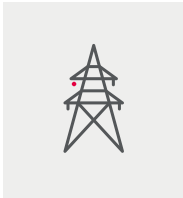

Energy distribution

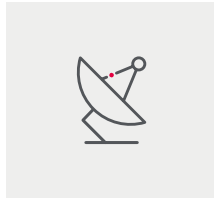

Telecommunications, Data centres and critical facilities

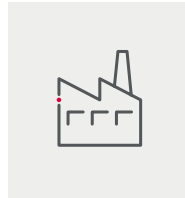

Industrial sector

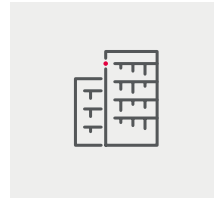

Tertiary sector, buildings and infrastructures

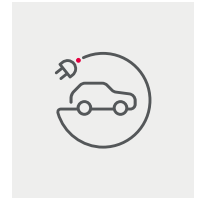

Electric mobility

Innovation and development

We are committed to innovation, incorporating cutting-edge technology to continue proposing more efficient solutions in the electric sector.



Production centres

We manufacture our own products in 6 centres located in Viladecavalls, Barcelona, Santa Perpètua, and Mexico.



CIRCUTOR technology

Boasting an in-house R&D team made up of more than 100 engineers who work designing new products to meet market demand..

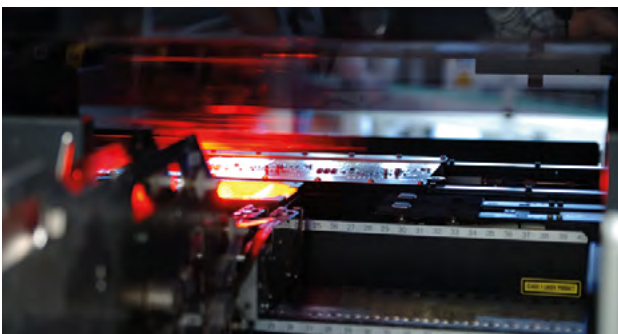

Testing laboratory

CIRCUTOR boasts in-house laboratories for compatibility testing (EMC/EMI), calibration and official metrological verification laboratory, which guarantee the highest quality.

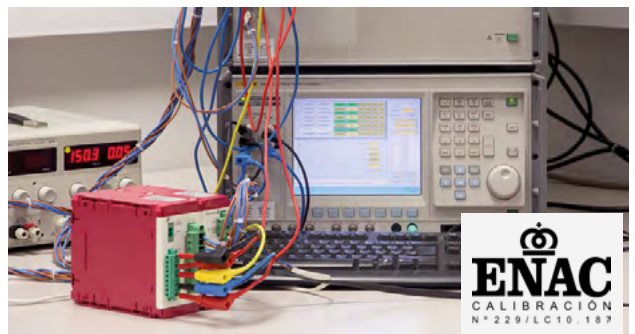

With all CIRCUTOR Services

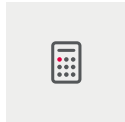

Pre-sale Services

—
Low voltage capacitor bank sizing

—
Harmonic filtering sizing

—
MV reactive power compensation projects

—
Energy efficiency systems installation (EMS)

—
Data analysis for energy audits

—
Assessment to collaborators

—
Support
Monday - Friday from
08 am to 6 pm.
(+34) 937 452 900

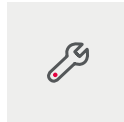

Technical Assistance Service (TAS)

Monday to Thursday
9 am to 2 pm and 3 pm to 5 pm.

Friday from 9 am to 2 pm.
(+34) 937 452 919
sat@circutor.com

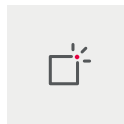

After-sales services

Maintenance or repair of devices, is guaranteed through the comprehensive TAS service of CIRCUTOR.



Logistics

More than 3,000 references available in stock.

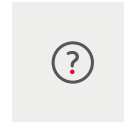

Technical support

Specialists at your disposal to answer any technical questions.

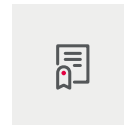

Equipment calibration

Equipment calibration service in in-house laboratory with ENAC certification.



Continuous training programmes for partners and customers

—
Online training sessions all year round

—
On-site technical training

—
Visits and specific sessions for training centres

→ [More information at circutor.com](https://www.circutor.com)

Energy Management Systems

What is energy efficiency?

Energy efficiency consists of optimising the energy resources of an electrical installation to reduce power consumption and improve productivity without affecting the usual activity, whether in buildings, industries or distribution networks.

Why is it necessary?

Because proper energy management allows you to obtain the following benefits:

- I Reduce the economic cost of operating facilities and processes, by optimising and reducing consumption (kWh, kvarh).
- I Avoiding penalties, whether for reactive energy consumption or for maximum demand.
- I Ensure the sustainability of the economic system and the preservation of the environment by reducing CO₂ emissions.
- I Optimising the performance of the facilities, avoiding unnecessary consumption and improving technical management.
- I Avoiding indirect costs due to production process failures or breakdowns (leak control and harmonic filtering).

How to apply it?

CIRCUTOR has the necessary equipment within its 6 product families:



MEASUREMENT AND CONTROL

Measurement and supervision of the main electrical parameters of the installation.



PROTECTION AND CONTROL

Protection of facilities, equipment and people.



METERING

Consumption and billing management through energy meters.



REACTIVE COMPENSATION

Power factor correction and harmonic filtering to save on energy bill.



ELECTRIC MOBILITY

Smart points for recharging electric vehicles.



RENEWABLE ENERGY SOURCES

Integral solutions for the monitoring of photovoltaic installations.

PRODUCT RANGE

Measurement and Control	9
Fixed power analyzers	11
Measuring transformers and shunts	23
Portable power analyzers	39
Digital instruments	42
Analogue instruments	49
Industrial IoT and Automation	69
EMS Datalogger and SCADA Embedded	70
Converters and gateways	72
Input and Output Centralisers	72
ARM edge controllers	73
ESP32 edge controllers	74
Metering	77
Multifunction electrical energy meters	78
PRIME Remote Management	80
Advanced low voltage monitoring	81
Partial consumption energy meters	85
Protection and control	89
Residual current protection	90
Self-reclosing overcurrent and Residual current protection	98
Residual current protection for electric vehicles	107
Relays and control elements	109
Protection current transformer	110
Measuring and testing equipments for substations	112
Power factor correction and harmonic filtering	113
Power factor regulators	115
Low voltage power capacitors	116
Low voltage capacitor banks	127
Harmonic filters	138
Capacitor and MV accessories	142
Management software	148

If you are interested in Electric Mobility and/or Renewable Energies, consult the specific catalogue or contact us at info@circutor.com.

Measurement and Control

Fixed power analyzers

Panel mounted power analyzers	12
CVM-A Power quality analyzers, colour display, panel mounted	12
CVM-B Power analyzer, colour display, panel mounted	12
M-CVM-AB Expansion modules for CVM-A and CVM-B	12
CVM-C11 Power analyzer, panel mounted 96 x96	13
MFC-FLEX Rogowski flexible sensors for FLEX devices	13
CVM-C4 Power analyzer, panel mounted 96x96	13
DIN rail power analyzers	14
CVM-E3-MINI Power analyzer, three-phase DIN rail	14
MFC-FLEX Rogowski flexible sensors for FLEX devices	14
CVM-D400 Multi-channel network analyser with memory, DIN rail	14
SCV1 Current transformers, split core	14
CVM-D50 Three-phase power analyser with DIN-rail memory	15
CVM-D41 DC Programmable DC measurement device	15
MC1, Triple scale single-phase efficient transformers	15
MC3, Three-phase current transformers	15
SC3, Split three-phase current transformers	15
Line system	16
Line-CVM-D, Power analyzer, Line series	16
Line-M-20I Expansion modules pulse inputs, Line series	16
Energy meters	17
CEM-C5 Direct Single-phase active energy meter	17
CEM-C12c Direct Single-phase energy meter with basic analyser parameters	17
CEM-C Energy meter	17
Power quality analyzers	18
QNA 600 Advanced power quality analyzers (according Standard UNE-EN-50160 and IEC 61000-4-30)	19
Quality Analyst_Scout Cloud-Scout software	19
CVM-A Power quality analyzers, colour display, panel mounted	19
Accessories	20
Converters and gateways	20
PowerStudio Universe, Energy management software	20
DATABOX, DataBox Cloud software	20

Measuring transformers and shunts

Table: Current transformers and shunts selection	23
TD, Current transformers narrow section	24
TD, Current transformers narrow section	25
TDH, High precision current transformer	25
TDH, High precision current transformer	26
TQ, Current transformers split core, button opening	27
TQR, Current transformers split core	28
STQ, Current transformers, split core	28
TM45, Current transformers, winding primary, DIN rail	29
SC3, Split three-phase current transformers	29
MC3, Three-phase current transformers	29
MC1, Triple scale single-phase efficient transformers	29
TA210, Current transformers, winding primary	30
TA, Current transformers	30
kit3-TRMC210 Kit of 3 current transformers for energy meters, primary winding	31
kit3-TRMC400 Sets of 3 current transformers for energy meters	31
TRMCx3, Current transformers for energy meters	31
TRM, Measuring transformers encapsulated in resin	32
SH, Shunts for direct current measurement	33
VT, Measurement voltage transformers	34
TSR, Current adding transformer	34
TE, Impedance elevator transformer	34

Portable power analyzers

MYeBOX-A, Portable power analyzer with recording of quality events and transients Calibration Certificate (IEC 61000-4-30 Ed.2) Class A	40
MYeBOX, Portable power analyzer with recording of quality events and transients in accordance with (IEC 61000-4-30 Ed.2) Class A	40
FLEX-R Flexible sensors for MYeBOX analysers	41
FLEX-RMG Flexible sensors for MYeBOX analysers	41
CPG Clamps	41
CFG, Residual current sensors (leaks)	41

Digital instruments

DCB Digital instrument.....42
 DHC-96 Digital instruments 96 x 4843
 DHC-96 CPM Digital instruments: Programmable DC measurement Central.....43
 DCP-96 Digital instruments 96 x 9643
 Table: Measurement transducer selection.....44
 Converters.....44
 CVE/CCE/CFE Narrow section transducers44
 CV Voltage transducer.....44
 CC Current transducer44
 CW, Active power transducer.....45
 CY, Reactive power transducer.....45
 CF, Frequency transducers.....45
 CT-PT, Temperature transducer.....45
 TI, Current transformer with converter 4 ... 20 mA.....47
 TC-420, Current transformers with converter 4 ... 20 mA or 0 ... 20 mA.....47

Analogue instruments

Analogue instrument selection table49
 EC / EM / EZC / CEC, Moving Iron Ammeter50
 EC / CEC, Moving Iron Voltmeters53
 BC / CBC, Moving coil ammeters55
 BC / CBC, Moving coil voltmeters56
 BC / ZC, Process indicators57
 MC / EMC, Maximeter ammeters.....59
 HC, Pointer type frequencymeters.....60
 HLC, Reed type frequencymeters.....60
 WMC / WTC, Wattmeters61
 FEMC / FETC, Electronic Phasemeters.....62
 PGR, Protection Wattmeters.....62
 2EC, Double voltmeters63
 SynchroMAX, Synchronization equipment.....63
 2HC, Double frequencymeters63
 2HLC, Double Reed type frequencymeters63
 SMC / STC, Synchrosopes, 50 Hz.....63
 UC / CUC, Phase sequence indicators, 50 Hz63
 CH, Hour run meters.....64
 MEG-1000, Insulation resistance meter.....64
 Accessories / Options for analogue instruments.....65

Fixed power analyzers

		CVM-A1500 CVM-A1500A	CVM-B150 CVM-B100	CVM-C11	CVM-C4	CVM-E3- MINI	Line- CVM-D32	NEW CVM D50	NEW CVM-D4000	CVM-D41DC
Mounting	Panel (mm)	144x144	144x144 / 96x96	96x96	96x96	OP (72x72)	OP (72x72)	OP (72x72)	-	-
	DIN rail (modules)	-	-	-	-	3	3	3	6	6
AC Measurement	Three-phase 3/4 wires	Config	Config		Config	Config			•	-
	Single-phase	Config	Config		Config	Config			•	•
	Quadrants	4	4	4	4	4	4	4	4	4
	Harmonics	63	50	31	-	31	40	31	15	-
	Phase parameters	•	•	•	•	•	•	•	•	•
	Maximum demand	•	•	•	-	•	•	•	•	-
	Tariffs	3	3	3	2	2	1	2	1	-
	Hours, cost, kgCO ₂	•	•	•	-	•	•	•	-	-
Voltage input	Direct (V)	600 V _{F-N} 1000 V _{F-F}	600 V _{F-N} 1000 V _{F-F}	300 V _{F-N} 520 V _{F-F}	300 V _{F-N} 520 V _{F-F}	300 V _{F-N} 520 V _{F-F}	300 V _{F-N} 520 V _{F-F}	300 V _{F-N} 520 V _{F-F}	300 V _{F-N} 520 V _{F-F}	1500 V _{F-N}
	Indirect (V)	Config.	Config.	Config.	Config.	Config.	Config.	Config.	-	-
Current Input	Direct	-	-	-	-	-	-	-	-	Shunt
	Indirect (ITF)	•	•	ST	•	ST	•	ST	-	-
	MC System (/250 mA)	•	•	ST	-	ST	•	ST	•	-
	Rogowski sensors	ST	-	ST	-	ST	-	ST	-	-
	SVC System (/333 mV)	-	-	-	-	-	-	-	ST	-
Communications	RS-485	•	•	ST	•	ST	•	-	•	•
	Ethernet (TCP/IP)	•	OP	ST	-	ST	-	•	•	-
	WiFi	-	-	-	-	ST	-	•	•	-
	Web server	•	OP	-	-	ST	-	•	•	-
	APP	-	-	-	-	•	-	•	•	-
Protocols	ModBus/RTU	•	•	ST	•	ST	•	-	•	•
	ModBus/TCP	OP	OP	ST	-	ST	-	•	•	-
	XML	•	OP	-	-	-	-	-	-	-
	MBUS	OP	OP	-	-	-	-	-	-	-
	BACnet	•	•	•	-	ST	-	-	-	-
	LonWorks	OP	OP	-	-	-	-	-	-	-
Others	Display	Colour graph	Colour graph	LCD	LED	LCD	TFT RGB	-	LED	LCD
	Expandible	•	•	-	-	-	•	-	-	-
Optional	Digital inputs (n.max)	2	2	2	2	1(ST)	(OP*)	-	-	2
	Digital outputs (n.max)	2+2relé	2+2relé	2+2relé	2+2relé	1(ST)	2(OP*)	-	4	2 relé
	Analogue inputs (n.max)	OP	OP	-	-	-	(OP*)	-	-	-
	Analogue outputs (n.max)	OP	OP	-	-	-	(OP*)	-	-	1
	Historical data record	•	OP	-	-	-	(OP*)	•	•	-
Standards	UL certificated	•	•	-	-	-	-	-	-	-
	Measurement in acc. with MID	•	•	-	-	•	•	•	-	-
	Measurement in acc with IEC 61000-4-30	ST	-	-	-	-	-	-	-	-
	Calibration certificate in compliance with IEC 61000-4-30	ST	-	-	-	-	-	-	-	-
	Page	12	12	13	13	14	16	15	14	15

(T) - depending on the type / (OP) - Optional

Panel mounted power analyzers

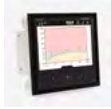

CVM-A Power quality analyzers, colour display, panel mounted

Power supply 100...240 Vac / 120...300 Vdc, 600 VPh-N / 1000 VPh-Ph measurement

Type	Code	Energy accuracy	Input current	Transistor output	Relay output	Digital inputs	Communications	Protocol	Harmonics	Certification	Memory
CVM-A1500A-ITF-485-ICT2	[2] M563110000A00	0,2S (.../5A)	.../5 A .../1 A 250 mA	2	2	2	RS-485 Ethernet	Modbus/RTU BACnet webserver (HTTP) XML HTML5	63	IEC 61000-4-30 (Class A)	200 MB
CVM-A1500A-FLEX-485-ICT2	[2] M563510000A00	1	Rogowski	2	2	2	RS-485 Ethernet	Modbus/RTU BACnet webserver (HTTP) XML HTML5	63	IEC 61000-4-30 (Class A)	200 MB
CVM-A1500-ITF-485-ICT2	[*] M56311.	0,2S (.../5A)	.../5 A .../1 A 250 mA	2	2	2	RS-485 Ethernet	Modbus/RTU BACnet webserver (HTTP) XML HTML5	63	-	200 MB
CVM-A1500-FLEX-485-ICT2	[*] M56351.	1	Rogowski	2	2	2	RS-485 Ethernet	Modbus/RTU BACnet webserver (HTTP) XML HTML5	63	-	200 MB

Four-quadrant measuring device with PowerStudio embedded. Integrated Datalogger module. Optional Modbus/TCP. 200MB Internal memory

See expansion modules and accessories (sealing gaskets) for CVM-A/CVM-B.

Precision power without connected sensors.



CVM-B Power analyzer, colour display, panel mounted

Power supply 100...240 Vac / 120...300 Vdc, 600 VPh-N / 1000 VPh-Ph measurement

Type	Code	Size (mm)	Energy accuracy	Input current	Transistor output	Relay output	Digital inputs	Communications	Protocol
CVM-B150-ITF-485-ICT2	[*] M56111.	144 x 144	0,5 S (.../5A)	.../5 A .../1 A .../250 mA	2	2	2	RS-485	Modbus/RTU BACnet
CVM-B100-ITF-485-ICT2	[*] M56011.	96 x 96	0,5 S (.../5A)	.../5 A .../1 A .../250 mA	2	2	2	RS-485	Modbus/RTU BACnet

4-quadrant measuring unit. See expansion modules and accessories (Sealing gaskets) for CVM-A / CVM-B



M-CVM-AB Expansion modules for CVM-A and CVM-B

Type	Code	Transistor output	Relay output	Digital inputs	Analogue Input	Analogue output	Communications	Protocol	Memory
M-CVM-AB-8I-80TR	[*] M56E01.	8	-	8	-	-	-	-	-
M-CVM-AB-8I-80R	[*] M56E02.	-	8	8	-	-	-	-	-
M-CVM-AB-4AI-8A0	[*] M56E03.	-	-	-	4 (0/4 ... 20 mA)	8 (0/4 ... 20 mA)	-	-	-
M-CVM-AB-Modbus-TCP (bridge)	[*] M56E05.	-	-	-	-	-	Ethernet	Modbus/TCP (gateway to RS485)	-
M-CVM-AB-Modbus-TCP (switch)	[*] M56E0A.	-	-	-	-	-	Ethernet	Modbus/TCP (gateway to TCP)	-
M-CVM-B-DATALOGGER	[*] M56E06.	-	-	-	-	-	Ethernet	Webserver HTML5 XML	200 MB
M-CVM-AB-MBUS	[*] M56E07.	-	-	-	-	-	M-BUS	M-BUS	-

Adapters

Type	Code	Description
IP65-AB-96	[*] M5ZZ5U.	IP 65 airtight seal for CVM-AB (96x96)
IP65-AB-144	[*] M5ZZ5V.	IP 65 airtight seal for CVM-AB (144x144)

NEW



CVM-C11 Power analyzer, panel mounted 96 x96

Type	Code	Power supply	Measuring Channels	Input current	Nr Sensors	Tr. output	Relay output	Digital inputs	Communications	Protocol	Harmonics
CVM-C11-ITF-IN-ETH-ICT2	[*] M58531.	100...270 Vac/dc	4	.../5 A .../1 A	-	2	2	2	Ethernet	Modbus/TCP BACnet	31
CVM-C11-ITF-IN-485-ICT2	[*] M58541.	100...270 Vac/dc	4	.../5 A .../1 A	-	2	2	2	RS-485	Modbus/RTU BACnet	31
CVM-C11-MC-IN-485-ICT2	[*] M58581.	100...270 Vac/dc	4	.../250 mA	-	2	2	2	RS-485	Modbus/RTU BACnet	31
CVM-C11-FLEX-IN-485-ICT2	[*] M58561.	100...270 Vac/dc	4	Rogowski	-	2	2	2	RS-485	Modbus/RTU BACnet	31
Kits											
CVM-C11-FLEX+3 MFC-FLEX-80	[*] M58562.	100...270 Vac/dc	4	Rogowski	3 x MFC-FLEX-80	2	2	2	RS-485	Modbus/RTU BACnet	31
CVM-C11-FLEX+3 MFC-FLEX-125	[*] M58563.	100...270 Vac/dc	4	Rogowski	3 x MFC-FLEX-125	2	2	2	RS-485	Modbus/RTU BACnet	31
CVM-C11-FLEX+4 MFC-FLEX-80	[*] M58564.	100...270 Vac/dc	4	Rogowski	4 x MFC-FLEX-80	2	2	2	RS-485	Modbus/RTU BACnet	31
CVM-C11-FLEX+4 MFC-FLEX-125	[*] M58565.	100...270 Vac/dc	4	Rogowski	4 x MFC-FLEX-125	2	2	2	RS-485	Modbus/RTU BACnet	31



MFC-FLEX Rogowski flexible sensors for FLEX devices

Type	Code	Measurement Range (A)	A Max.	Usefull diam.(mm)	Sensor lenght	cable Length(m)
MFC-FLEX-80	[*] M82111.	1000 A / 100 mV @ 50 Hz. (RMS values) 1000 A / 120 mV @ 60 Hz. (RMS values)	100000	80	250 mm	3
MFC-FLEX-125	[*] M82114.	1000 A / 100 mV @ 50 Hz. (RMS values) 1000 A / 120 mV @ 60 Hz. (RMS values)	100000	125	400 mm	3

Compatible only with FLEX type devices. Only one sensor is supplied per code The clamp limit for CVM-E3-MINI-FLEX is 2 kA, for CVM-C11-FLEX 3 kA and for CVM-A1500-FLEX 10 kA.



CVM-C4 Power analyzer, panel mounted 96x96 96x96 panel - 80...270 Vac / 80...270 Vdc power supply

Type	Code	Measuring Channels	Input current	Transistor output	Relay output	Digital inputs	Communications	Protocol
CVM-C4-ITF-485-ICT2	[C] M52706.	3	.../5 A .../1 A	2	2	2	RS-485	Modbus/RTU

4-quadrant measuring unit. Can be used to program the voltage transformer ratio

TABLE OF ADDITIONAL FEATURES

CVM-B, CVM-A

	M	5	X	X	X	X	0	0	X	X	X	X	X	
Code														Delivery time
Power supply voltage	Standard (100...270 V _{ac} / 120...300 V _{dc})								0				-	
	20...120 V _{dc}								F				1	
Others	Metric fork terminals 3 - CAT III 300 V								B	T			-	

CVM-C4

	M	5	X	X	X	X	0	0	X		
Code										Delivery time	
Power supply voltage	Estándard (80...270 V _{ac} / ...)								0		-
	18 ...36 V _{dc}								3		1

DIN rail power analyzers



CVM-E3-MINI Power analyzer, three-phase DIN rail

Type	Code	Power supply	Input current	Transistor output	Digital inputs	Communications	Protocol	Harmonics
CVM-E3-MINI-ITF-485-IC	[*] M56414.	207...253 Vac	.../5 A .../1 A	1	1	RS-485	Modbus/RTU BACnet	31
CVM-E3-MINI-MC-485-IC	[*] M56424.	207...253 Vac	.../250 mA	1	1	RS-485	Modbus/RTU BACnet	31
CVM-E3-MINI-FLEX-485-IC	[*] M56454.	207...253 Vac	Rogowski	1	1	RS-485	Modbus/RTU BACnet	31
CVM-E3-MINI-ITF-WiEth	[*] M56470.	90...264 Vac/Vdc	.../5 A .../1 A	-	-	Ethernet Wi-Fi	Modbus/TCP	31
CVM-E3-MINI-MC-WiEth	[*] M56480.	90...264 Vac/Vdc	.../250 mA	-	-	Ethernet Wi-Fi	Modbus/TCP	31
CVM-E3-MINI-FLEX-WiEth	[*] M56490.	90...264 Vac/Vdc	Rogowski	-	-	Ethernet Wi-Fi	Modbus/TCP	31

Built-in wireless communication on all WiEth models for configuration via free app (MyConfig) RS-485 models, possibility of switching power supply Consult additional benefits



MFC-FLEX Rogowski flexible sensors for FLEX devices

Type	Code	Measurement Range (A)	A Max.	Usefull diam.(mm)	Sensor lenght	cable Lenght(m)
MFC-FLEX-80	[*] M82111.	1000 A / 100 mV @ 50 Hz. (RMS values) 1000 A / 120 mV @ 60 Hz. (RMS values)	100000	80	250 mm	3
MFC-FLEX-125	[*] M82114.	1000 A / 100 mV @ 50 Hz. (RMS values) 1000 A / 120 mV @ 60 Hz. (RMS values)	100000	125	400 mm	3

Compatible only with FLEX type devices. Only one sensor is supplied per code The clamp limit for CVM-E3-MINI-FLEX is 2 kA, for CVM-C11-FLEX 3 kA and for CVM-A1500-FLEX 10 kA.

Adapters

Type	Code	Description
Adap-Panel-D3M	[*] M5ZZF100000E3	Panel adapter CVM-E3-MINI, RGU, CBS (72 x 72)

NEW



CVM-D400 Multi-channel network analyser with memory, DIN rail

Self-powered, 300 Vph-n / 520 Vph-ph measurement, TDH measurement in voltage and current

Type	Code	N° Input channels	Input current	Nr Sensors	Transistor output	Communications	Protocol	Harmonics	Memory
CVM-D420-MC	[*] M551A2.	1...2(III) 1...12(II)	.../250 mA	-	2	Wi-Fi Ethernet RS-485	Modbus/TCP Modbus/RTU	15	1
CVM-D421-SCV	[*] M55132.	1...2(III) 1...6(II)	.../333 mV	-	2	Wi-Fi Ethernet RS-485	Modbus/TCP Modbus/RTU	15	1
CVM-D440-MC	[*] M551A4.	1...4(III) 1...12(II)	.../250 mA	-	4	Wi-Fi Ethernet RS-485	Modbus/TCP Modbus/RTU	15	1
CVM-D441-SCV	[*] M55134.	1...4(III) 1...12(II)	.../333 mV	-	4	Wi-Fi Ethernet RS-485	Modbus/TCP Modbus/RTU	15	1

Kits

kit CVM-D421+2xSCV1	[*] M55136.	1...2(III) 1...6(II)	.../333 mV	3 x SCV	2	Wi-Fi Ethernet RS-486	Modbus/TCP Modbus/RTU	15	1
kit CVM-D441+4xSCV1	[*] M55138.	1...4(III) 1...12(II)	.../333 mV	3 x SVC	4	Wi-Fi Ethernet RS-487	Modbus/TCP Modbus/RTU	15	1

The -MC models require MC1/MC3 type transformers and the -SCV require SCV1 type transformers



SCV1 Current transformers, split core

Type	Code	A Max.	Class 0,5 Power (VA)	Usefull diam.(mm)	cable Lenght(m)
3xSCV1-100A/333mV	[*] M73811.	100	0.5	16	1.5

SCV1s are transformers with 333 mV output

TABLE OF ADDITIONAL FEATURES

CVM-E3-MINI Comunicaciones

M	5	X	X	X	X	0	0	X
Code	Internal code	↑		Delivery time	+ €			
Power supply voltage	Standard 207...253 Vac	0	-					
	90...264 Vac/Vdc	D	1					

NEW

CVM-D50 Three-phase power analyser with DIN-rail memory

Type	Code	Power supply	Input current	Communications	Protocol	Harmonics	Memory
CVM-D50-ITF	[*] M56570.	90...264 Vac/Vdc	.../5 A .../1 A	Ethernet Wi-Fi	Modbus/TCP	31	1
CVM-D50-MC	[*] M56580.	90...264 Vac/Vdc	.../250 mA	Ethernet Wi-Fi	Modbus/TCP	31	1
CVM-D50-FLEX	[*] M56590.	90...264 Vac/Vdc	Rogowski	Ethernet Wi-Fi	Modbus/TCP	31	1

It has a free configuration App (MyConfig) and WebServer for configuration, visualization and data download



CVM-D41 DC Programmable DC measurement device

Type	Code	System	Parameters	Measu- rement Range U	Measu- rement Range I	Output relay	Digital inputs	Analog output	Power supply	Commu- nications	Protocol
Multimeter											
CVM-D41 DC mA	[*] M56638.	DC (Shunt)	V/A/kW/kWh	1500 Vdc	50 ... 600 mV	2	2	1 (20 mA)	100...270 Vac/dc	RS-485	Modbus/RTU
CVM-D41 DC mA	[*] M566380040000	DC (Shunt)	V/A/kW/kWh	1500 Vdc	50 ... 600 mV	2	2	1 (20 mA)	20...60 Vdc	RS-485	Modbus/RTU
CVM-D41 DC V	[*] M5663A.	DC (Shunt)	V/A/kW/kWh	1500 Vdc	50 ... 600 mV	2	2	1 (0 ... 10V)	100...270 Vac/dc	RS-485	Modbus/RTU
CVM-D41 DC V	[*] M5663A0040000	DC (Shunt)	V/A/kW/kWh	1500 Vdc	50 ... 600 mV	2	2	1 (0 ... 10V)	20...60 Vdc	RS-485	Modbus/RTU

Accessories



MC1, Triple scale single-phase efficient transformers

Type	Code	Measurement Range (A)	A Max.	Class 0,5 Power (VA)	System	Usefull diam.(mm)
MC1-15-75	[*] M73112.	75	75	0.25	Single-phase	15
MC1-20-50/100/150 A	[*] M73118.	50/100/150	150	0.25	Single-phase	20
MC1-35-50/100/150 A	[*] M73116.	50/100/150	150	0.25	Single-phase	35
MC1-20-150/200/250 A	[*] M73113.	150/200/250	250	0.25	Single-phase	20
MC1-30-250/400/500 A	[*] M73114.	250/400/500	500	0.25	Single-phase	30
MC1-55-500/1000/1500 A	[*] M73115.	500/1000/1500	1500	0.25	Single-phase	55
MC1-80 1000/1500/2000 A	[*] M73117.	1000/1500/2000	2000	0.25	Single-phase	80

The MC/SC3 transformers with a 250 mA output are only compatible with network analysers type MC



MC3, Three-phase current transformers

Type	Code	A Max.	Class 0,5 Power (VA)	System	Usefull diam.(mm)
MC3 - 63 A	[*] M73121.	63	0.1	Three-phase	7,1
MC3 - 125 A	[*] M73122.	125	0.1	Three-phase	14,6
MC3 - 250 A	[*] M73123.	250	0.1	Three-phase	26

The MC/SC3 transformers with a 250 mA output are only compatible with network analysers type MC



SC3, Split three-phase current transformers

Type	Code	A Max.	Class 0,5 Power (VA)	System	Usefull diam.(mm)
SC3-125	[*] M73602.	125	0.1	Three-phase	15

The MC/SC3 transformers with a 250 mA output are only compatible with network analysers type MC

Line system



Line-CVM-D, Power analyzer, Line series

Type	Code	Measuring Channels	Input current	Transistor output	Communications	Protocol	Harmonics
Line-CVM-D32	[*] M58100.	3	.../5 A .../1 A .../250 mA	2	RS-485 Bus-Line	Modbus/RTU	40

Bus-Line: RS-485 communications system, with lateral side connector between modules



Line-M-4IO-R Expansion modules, Line series



Type	Code	Transistor output	Relay output	Digital inputs	Analogue Input	Analog output	Communications	Protocol
Input/Output Modules								
Line-M-4IO-T	[*] D73001.	4	-	4	-	-	Bus-Line	Modbus/RTU
Line-M-4IO-R	[*] D73002.	-	4	4	-	-	Bus-Line	Modbus/RTU
Line-M-8I6O	[*] D73008.	-	6	8	-	-	Bus-Line	Modbus/RTU
Line-M-4IO-A	[*] D73003.	-	-	-	4 (0/4 ... 20 mA)	4 (0/4 ... 20 mA) 4 (0/2 ... 10 Vdc)	Bus-Line	Modbus/RTU
Line-M-4IO-RV	[*] D73004.	-	4	4 (230 V)	-	-	Bus-Line	Modbus/RTU
Line-M-2OI	[C] D73006.	-	-	20	-	-	Bus-Line	Modbus/RTU

Relay I/O expansion modules, Line system

Type	Code	Description
Power supply		
Line-M-EXT-PS	[*] D7300A.	110-277 V ~ (P-N)/110-480 V ~ (P-P) power supply for maximum of 3 Line devices
Modem		
Line-M-4G	[*] D7300C.	4G/GPRS Communications modem and Bus-Line to communicate with Line-EDS devices
Ethernet converter		
Line-TCPRS1	[C] D80030.	RS-485/RS-232 to Ethernet/Wi-Fi converter (ModbusTCP/TCP/UDP) Integrated web server and mobile app (MyConfig) for configuration

4G Modem, expansion modules, Line system

Power quality analyzers

		NEW		
		QNA-600	CVM-A1500A	CVM-A1500
				
		Class A	Class A	Acc. Class A
Assembly	Panel (mm)	Rack 19"	144 x 144	144 x 144
Connection	Three-phase 3/4-wire	config.	config.	config.
	Quadrants	4	4	4
Power supply		180...300 V _{cc}	85-265V _{ca} / 120-300V _{cc} 20-120V _{cc} (OP)	85-265V _{ca} / 120-300V _{cc} 20-120V _{cc} (OP)
Parameters	Parameters per phase	●	●	●
	Power	0,5	0,2	0,2
	Active energy	0,5S	0,2S (.../5A)	0,2S (.../5A)
	Reactive energy	1	1	1
	Maximum demand	–	●	●
	Harmonics	64	63	63
	THD U / THD I	●	●	●
	Tariffs	–	3	3
	Hours, cost, kgCO2	–	●	●
Quality parameter measurements	Events (overvoltages, gaps and interruptions)	●	●	●
	EN50160 parameters	●	●	●
	Rapid Voltage Variations (RVC)	●	–	–
	Signal transmission over the network	●	–	–
	Voltage transients	●	●	●
	Current transients	●	–	–
	Waveform (of quality events)	●	●	●
Voltage input	Direct	500 V _{F-N} / 866 V _{F-F}	600 V _{F-N} / 1000 V _{F-F}	600 V _{F-N} / 1000 V _{F-F}
	Indirect	config	config	config
Input Current	.../5 A	●	●	●
	.../1 A	–	●	●
	.../250 mA	–	●	●
	Clamp (Rogoswki)	–	ST	ST
Inputs/outputs	Digital inputs	–	2	2
	Digital outputs	–	2	2
	Relay outputs	–	2	2
Comunicaciones	RS-485	–	●	●
	TCP/IP	●	●	●
	Wi-Fi	●	–	–
	4G	●	–	–
Interface	Colour screen	OLED	●	●
Protocols	ModBus/RTU	–	●	●
	ModBus/TCP	–	OP	OP
	XML / BACnet	–	●	●
	M-BUS	–	OP	OP
	IEC 61850	●	–	–
	HTTPS / API REST	●	–	–
	LonWorks	–	OP	OP
	Web server	●	HTML5	HTML5
	FTP + SFTP	●	–	–
Expansion modules	Digital inputs/outputs	–	OP (8 + 8)	OP (8 + 8)
	Digital inputs / Relay outputs	–	OP (8 + 8)	OP (8 + 8)
	Analogue inputs/outputs	–	OP (4 + 8)	OP (4 + 8)
Normas	IEC 61000-4-30	Clase A - Edic.3	Clase A	Según clase A
	According to UL	–	Certificado	Certificado
	Measuring in accordance with MID	●	●	●
	OP - Opcional			

NEW



QNA 600 Advanced power quality analyzers (according Standard UNE-EN-50160 and IEC 61000-4-30)

Power supply 180...300 Vac, measurement 500 VF-N / 866 VF-F

Type	Code	Energy accuracy	Class	Power supply	Input current	Communications	Protocol	Harmonics	Certification
QNA 600	[C] Q22010.	0,5s	A	180 ... 300 V~	... / 5 A	Ethernet Wi-Fi 4G	HTTPS - NTP - SFTP - IEC61850	64	IEC 61000-4-30 (Class A)

Accessories for QNA 600

Type	Code	Description
Pack-4bat	[] Q22003.	Replacement pack 4 QNA 600 batteries
Rack- 4U-19" 60x45028cm	[] Q22001.	19" 4U Wall Rack Accessory for QNA 600
DobleRack	[] Q2200A.	Accessory Double Rack Mount QNA 600

NEW



Quality Analyst_Scout Cloud-Scout software

Cloud-Scout Electrical monitoring and auditing software

Type	Code	Description
Quality Analyst_Scout	[*] W10320.	Module for the analysis and monitoring of power quality

Module prices are annual subscription prices per connected device.
Equipment compatible with the modules: Quality Analyst: QNA 600.

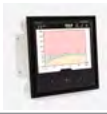

CVM-A Power quality analyzers, colour display, panel mounted

Power supply 100...240 Vac / 120...300 Vdc, 600 VPh-N / 1000 VPh-Ph measurement

Type	Code	Energy accuracy	Input current	Tran-sistor output	Relay output	Digital inputs	Commu-nications	Protocol	Harmoni-cs	Certifi-cation	Memory
CVM-A1500A-ITF-485-ICT2	[2] M563110000A00	0,2S (.../5A)	.../5 A .../1 A 250 mA	2	2	2	RS-485 Ethernet	Modbus/RTU BACnet webserver (HTTP) XML HTML5	63	IEC 61000-4-30 (Class A)	200 MB
CVM-A1500A-FLEX-485-ICT2	[2] M563510000A00	1	Rogowski	2	2	2	RS-485 Ethernet	Modbus/RTU BACnet webserver (HTTP) XML HTML5	63	IEC 61000-4-30 (Class A)	200 MB
CVM-A1500-ITF-485-ICT2	[*] M56311.	0,2S (.../5A)	.../5 A .../1 A 250 mA	2	2	2	RS-485 Ethernet	Modbus/RTU BACnet webserver (HTTP) XML HTML5	63	-	200 MB
CVM-A1500-FLEX-485-ICT2	[*] M56351.	1	Rogowski	2	2	2	RS-485 Ethernet	Modbus/RTU BACnet webserver (HTTP) XML HTML5	63	-	200 MB

Four-quadrant measuring device with PowerStudio embedded. Integrated Datalogger module. Optional Modbus/TCP. 200MB Internal memory
See expansion modules and accessories (sealing gaskets) for CVM-A/CVM-B.
Precision power without connected sensors.

TABLE OF ADDITIONAL FEATURES

CVM-A												
M	5	X	X	X	X	0	0	X	X	X	X	
Code	Internal code						↑	↑	↑	Delivery time		
Power supply voltage	Standard (100...270Vac / 120...300 Vdc)						0	↑	↑	-		
	20...120 Vdc						F	↑	↑	1		
Others	Metric fork terminals 3 - CAT III 300 V						B	T	-			

Delivery time: [*] Immediate, [x] working weeks, [c] Consult

Accessories



Converters and gateways

Type	Code	Description
RS		
RS2RS	[*] D80310.	RS-232/485 Intelligent converter and amplifier (RTS control) for PC
USB		
USB-RS 485	[*] D80320.	USB to RS-485 Converter
M-BUS		
CMBUS-8	[*] D80208.	M-Bus to Modbus Converter, up to 8 Mbus slaves
CMBUS-24	[*] D80224.	M-Bus to Modbus Converter, up to 24 Mbus slaves
LoRa		
Bridge LR PSAC	[*] D80110.	LoRa to RS-485 Converter (Modbus/RTU) . AC power supply (110...264 Vac)
Bridge LR PSDC	[*] D80111.	LoRa to RS-485 Converter (Modbus/RTU) . DC power supply (9 ... 36 Vdc)
Ethernet		
TCPRS1+	[*] D80010.	RS-485 to Ethernet/Wi-Fi converter (ModbusTCP/TCP/UDP) Integrated web server and mobile app (MyConfig Wifi) for configuration
TCPRS1+PSDC	[*] D80011.	RS-485 to Ethernet/Wi-Fi converter (ModbusTCP/TCP/UDP) Integrated web server and mobile app (MyConfig Wifi) for configuration

NEW

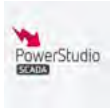

PowerStudio Universe, Energy management software

Type	Code	Description
SCADA software		
PowerStudio SCADA Basic	[*] W20100.	SCADA software for monitoring, control and analysis of installations, with CIRCUTOR devices and third-party Modbus equipment. Up to 25 devices
PowerStudio SCADA Pro	[*] W20110.	SCADA software for monitoring, control and analysis of installations, with CIRCUTOR devices and third-party Modbus equipment. Up to 50 devices
PowerStudio SCADA Ultimate	[*] W20120.	SCADA software for monitoring, control and analysis of installations, with CIRCUTOR devices and third-party Modbus equipment. Up to 500 devices.
PowerStudio SCADA Enterprise	[*] W20130.	SCADA software for monitoring, control and analysis of installations, with CIRCUTOR devices and third-party Modbus equipment. More than 500 devices.
OPC UA Server	[*] W20200.	Allows to configure an OPC UA server in PowerStudio for any SCADA with OPC UA client to integrate the desired parameters.
PS-DataBox	[*] W20300.	Connects PowerStudio software and DataBox cloud platform



DATABOX, DataBox Cloud software

DataBox data plans

Type	Code	Description
Plan		
LitePlan_Databox	[*] W10100.	6 Readings, 6 Alarms and 6 Actuators
SmallPlan_Databox	[*] W10101.	18 Readings, 18 Alarms and 18 Actuators
MediumPlan_Databox	[*] W10102.	55 Readings, 55 Alarms and 55 Actuators
BigPlan_Databox	[*] W10103.	100 Readings, 100 Alarms and 100 Actuators
User		
BasicUser_Databox	[*] W10110.	Viewing permissions
AdvancedUser_Databox	[*] W10111.	Viewing and editing permissions for graphical configuration and reports
AnalyticsUser_Databox	[*] W10112.	Permissions to view, analyse and edit graphical configuration and reports.
ProfessionalUser_Databox	[*] W10113.	Administrator permissions. A minimum of one user per partner is required
Service		
Act-Firmware_Databox	[*] W10120.	ePick GPRS VPN over-the-air firmware upgrade
ImportVar_Databox	[*] W10121.	Variable imported and stored in the platform
ModbusIntegration_Databox	[*] W10122.	Integration of a Modbus map of a new device
Brand_databox	[*] W10123.	Visual customisation of the platform (Name, DNS and background image)
API_Databox	[*] W10124.	Extensive use of the API. 1,000 first calls free of charge. Monthly charging of 25.000 calls packages.

All codes, with the exception of W10120, W10122, and W10124, correspond to monthly subscription prices. The prices for codes W10120, W10122, are one-time purchase prices. The price of code W10124, corresponds to 25,000 calls. A reading is understood as a variable that is periodically recorded, an alarm as an expression that is continuously evaluated locally and reported, and an actuator as a pre-configured (manual or programmed) remote control action.

Dimensions

CVM B100

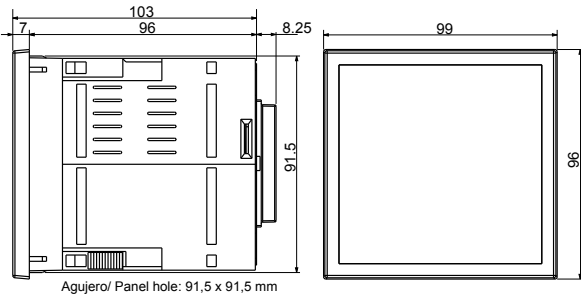

CVM B150

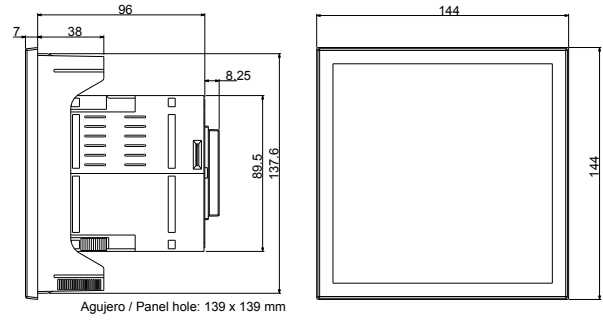

CVM C11

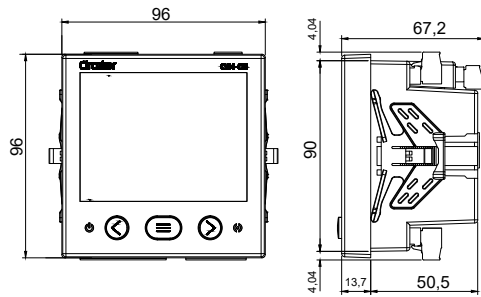

CVM A 1500 / CVM A 1500A

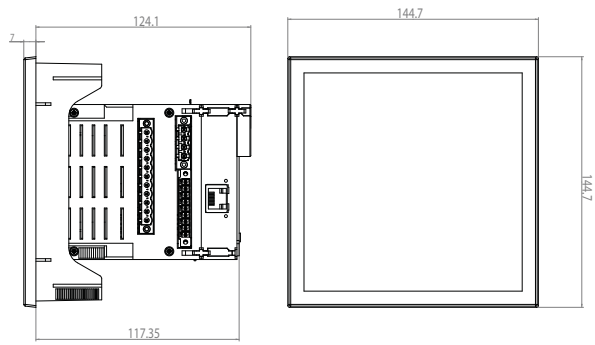

CVM C4

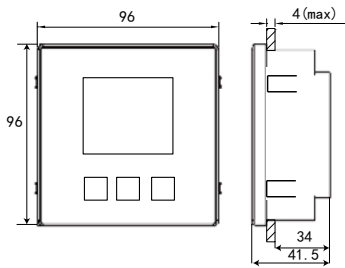

Line-CVM-D32

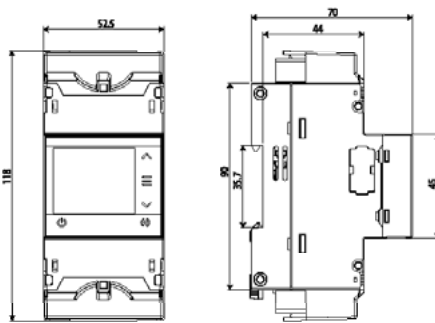

CVM-E3-MINI / CVM-D50

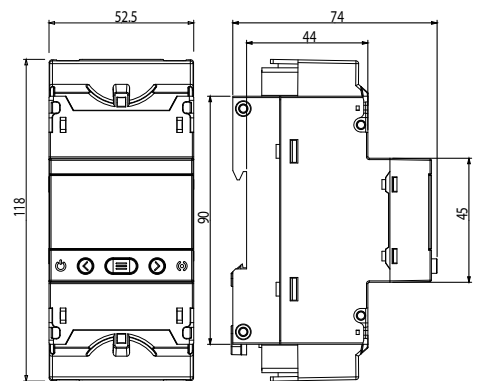

CVM D41

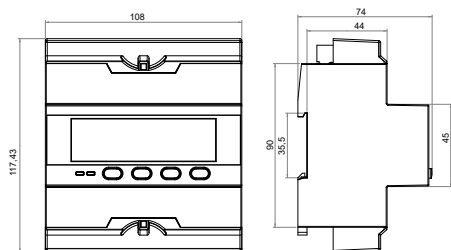

CVM D400

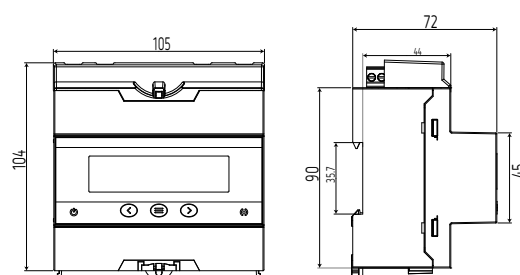

CEM-C10

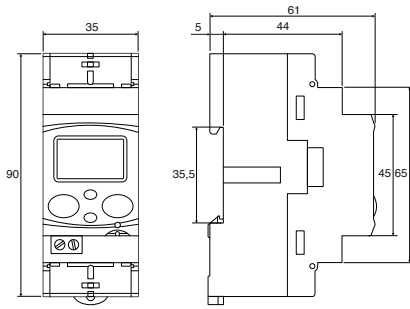

CEM-C21 / CEM-C31

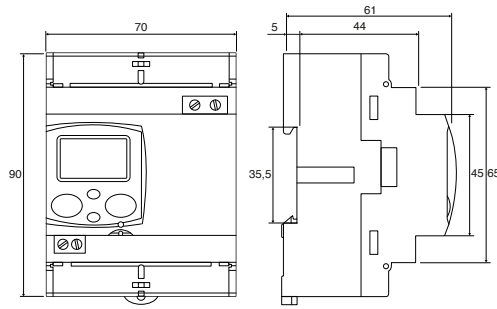

CEM-C5

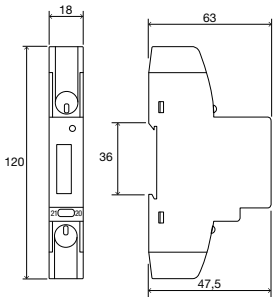

CEM-C12c

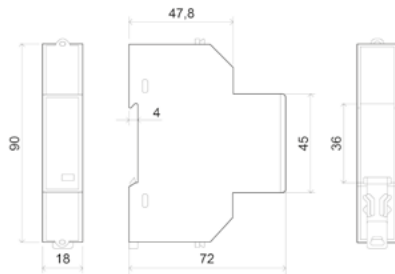

CEM-M

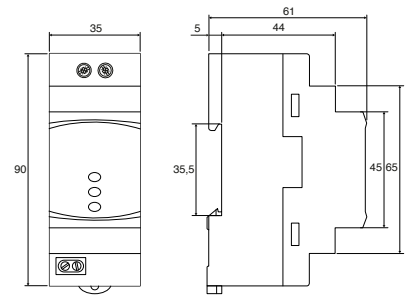

QNA600

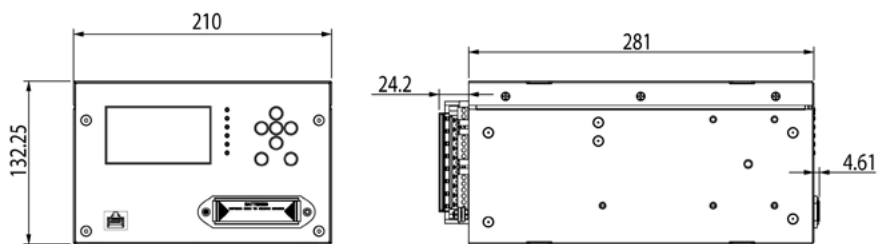

Measuring transformers and shunts

Table: Current transformers and shunts selection





		TD	TDH	TA	TQ	TQR	STQ	MC	TM 45	TRMC	TRM	SH
AC Measurement	For billing meters	-	-	-	-	-	-	-	-	•	-	-
	For measuring instruments	•	•	•	•	•	•	•	•	-	•	•
	Wound primary	-	-	T	-	-	-	-	•	T	-	-
	Passing bar	•	•	T	•	•	-	•	-	T	•	-
	Split-core	-	-	-	•	•	•	-	-	-	-	-
	Minimum range (A)	40 A	60 A	5 A	100 A	400 A	100 A	50 A	1 A	50 A	75 A	-
	Maximum range (A)	4000 A	4000 A	5000 A	5000 A	2000 A	300 A	2000 A	50 A	3000 A	5000 A	-
	High accuracy	-	•	-	-	-	-	-	-	-	-	-
	Three-phase	-	-	-	-	-	-	T	-	T	-	-
	DC measurement	Minimum range (A)	-	-	-	-	-	-	-	-	-	-
	Maximum range (A)	-	-	-	-	-	-	-	-	-	-	20000 A
Other parameters	Secondary output	.../5 A (*2)	.../5 A (*1)	.../5 A (*1)	.../5 A (*2)	.../5 A (*2)	.../5 A (*2)	250 mA	.../5 A (*1)	.../5 A (*1)	.../5 A (*1)	.../60 mV (*3)
	in resin	OP	OP	-	-	-	-	-	-	•	•	-
	Sealable	•	•	-	•	-	-	-	-	-	-	-
	UL Certificate	-	-	T	-	-	-	-	-	-	-	-
	Individual certificate	OP	OP	OP	OP	OP	-	-	-	OP	OP	-

T - Depending on the type
 OP - Optional
 (*1) .../1 On demand
 (*2) .../1 A, .../250 mA on request
 (*3) Possibility of other outputs (secondary values)





TD/TDH rail fixing

Type	Code	Description
DIN-FIX 50x50	[*] M75102.	DIN-FIX 50x50;Description: DIN rail fixing 50 x 50 mm (TD4, TD5, TD5.2, TD6, TD6.2)
DIN-FIX 50x84	[*] M75103.	DIN-FIX 50x84;Description: DIN rail fixing 50 x 84 mm (TD8 / TDH8 / TD10 / TDH10)
TD4-COVER	[*] M75111.	TD4 / TDH4-COVER;Description: Terminal cover/label for TD4 / TDH4 + secondary cap
TD5/TD5.2-COVER	[*] M75121.	TD5-COVER;Description: Terminal cover/label for TD5 / TDH5 / TD5.2 / TDH5.2 + secondary cap
TD6/TD6.2-COVER	[*] M75141.	TD6-COVER;Description: Terminal cover/label for TD6 / TDH6 / TD6.2 / TDH6.2 + secondary cap
TD8-COVER	[*] M75161.	TD8-COVER;Description: Terminal cover/label for TD8 / TDH8 + secondary cap
TD10-COVER	[*] M75171.	TD10-COVER;Description: Terminal cover/label for TD10 / TDH10 + secondary cap
TD12-COVER	[*] M75181.	TD12-COVER;Description: Terminal cover/label for TD12 / TDH12 + secondary cap

TD, Current transformers narrow section



Type	TD4	TD5	TD5.2									
	 width x height x depth (mm) 50 x 80 x 48	 width x height x depth (mm) 58 x 84 x 53	 width x height x depth (mm) 58 x 84 x 53									
ø (mm)	20		22									
Flat strip(mm)	15 x 15 20 x 10 25 x 5		25 x 10 30 x 10 20 x 12									
A	Class / VA				Class / VA				Class / VA			
	0,5	1	3	Code	0,5	1	3	Code	0,5	1	3	Code
40/5	-	-	1,25	[*] M75011.								
50/5	-	1	1,5	[*] M75012.	-	0,5	1,5	[*] M75022.				
60/5	-	1,25	2,5	[*] M75013.	-	1	2,5	[*] M75023.				
75/5	-	1,5	3,75	[*] M75014.	-	1,5	3,5	[*] M75024.				
100/5	1,5	2,5	5	[*] M75015.	1,5	2,5	3,75	[*] M75025.	-	-	1	[*] M750A5.
125/5	2,5	3,75	5	[*] M75016.	1,5	2,5	3,75	[*] M75026.	-	1	1,5	[*] M750A6.
150/5	3,75	5	5	[*] M75017.	1,5	2,5	3,75	[*] M75027.	1	1,5	2,5	[*] M750A7.
200/5	5	7,5	7,5	[*] M75018.	2,5	3,75	5	[*] M75028.	1,5	2,5	3,5	[*] M750A8.
250/5					2,5	3,75	5	[*] M75029.	2,5	3,5	5	[*] M750A9.
300/5									2,5	3,5	5	[*] M750AA.
400/5									2,5	3,5	5	[*] M750AB.
500/5									5	7,5	10	[*] M750AC.
600/5									5	7,5	10	[*] M750AD.

For other configurations see table of additional features

Type	TD6.2	TD6	TD8									
	 width x height x depth (mm) 66 x 91 x 53	 width x height x depth (mm) 66 x 91 x 53	 width x height x depth (mm) 85 x 109 x 59									
ø (mm)	25	28	43									
Flat strip(mm)	25 x 12 30 x 10 20 x 20	20 x 25 30 x 15 40 x 10	50 x 30 60 x 12 13 x 45									
A	Class / VA				Class / VA				Class / VA			
	0,5	1	3	Code	0,5	1	3	Code	0,5	1	3	Code
100/5	1	2,5	3,5	[*] M75055.								
125/5	1,5	3,5	5	[*] M75056.								
150/5	2,5	3,5	5	[*] M75057.	1	2,5	3,5	[*] M75047.				
200/5	3,5	5	5	[*] M75058.	1,5	3,5	5	[*] M75048.				
250/5	3,5	5	5	[*] M75059.	2,5	5	5	[*] M75049.				
300/5	5	7,5	7,5	[*] M7505A.	2,5	5	5	[*] M7504A.	2,5	3,5	3,5	[*] M7506A.
400/5	5	7,5	7,5	[*] M7505B.	2,5	5	5	[*] M7504B.	2,5	3,5	5	[*] M7506B.
500/5	5	7,5	10	[*] M7505C.	5	7,5	7,5	[*] M7504C.	2,5	5	5	[*] M7506C.
600/5	5	7,5	10	[*] M7505D.	5	7,5	7,5	[*] M7504D.	2,5	5	5	[*] M7506D.
750/5					5	7,5	10	[*] M7504E.	2,5	5	5	[*] M7506E.
800/5					5	7,5	10	[*] M7504F.	5	7,5	7,5	[*] M7506F.
1000/5									5	7,5	10	[*] M7506G.
1200/5									5	7,5	10	[*] M7506H.
1250/5									7,5	10	10	[*] M7506J.
1500/5									7,5	10	15	[*] M7506K.
1600/5									7,5	10	15	[*] M7506L.

For other configurations see table of additional features





TD, Current transformers narrow section

Type	TD10	TD12						
								
	width x height x depth (mm) 108 x 131 x 69	width x height x depth (mm) 134 x 151 x 69						
ø (mm)	63	50						
Flat strip(mm)	50 x 50 60 x 30 80 x 30	100 x 50						
A	Class / VA				Class / VA			
	0.5	1	3	Code	0.5	1	3	Code
600/5	2,5	5	7,5	[*] M7507D.				
750/5	2,5	5	7,5	[*] M7507E.				
800/5	2,5	5	7,5	[*] M7507F.	2,5	5	7,5	[*] M7508F.
1000/5	2,5	5	7,5	[*] M7507G.	2,5	5	7,5	[*] M7508G.
1200/5	2,5	5	7,5	[*] M7507H.	5	10	15	[*] M7508H.
1250/5	2,5	5	7,5	[*] M7507J.	5	10	15	[*] M7508J.
1500/5	5	10	15	[*] M7507K.	7,5	15	20	[*] M7508K.
1600/5	5	10	15	[*] M7507L.	7,5	15	20	[*] M7508L.
2000/5	5	10	15	[*] M7507M.	7,5	15	20	[*] M7508M.
2500/5	5	10	15	[*] M7507N.	10	20	25	[*] M7508N.
3000/5	5	10	15	[*] M7507P.	10	20	25	[*] M7508P.
4000/5					15	20	25	[*] M7508Q.

For other configurations see table of additional features

NEW

TDH, High precision current transformer

Type	TDH4	TDH5	TDH5.2									
												
	width x height x depth (mm) 50 x 80 x 48	width x height x depth (mm) 58 x 84 x 53	width x height x depth (mm) 58 x 84 x 53									
ø (mm)	20		22									
Flat strip(mm)		15 x 15 20 x 10 25 x 5	25 x 10 30 x 10 20 x 12									
A	Class / VA				Class / VA				Class / VA			
	0.2	0.2S	0.5S	Code	0.2	0.2S	0.5S	Code	0.2	0.2S	0.5S	Code
60/5	0,5	0	0,5	[*] M77013.	0,5	0	0,5	[*] M77023.				
75/5	0,75	0,5	0,75	[*] M77014.	1	0,5	1	[*] M77024.				
100/5	1	0,5	1	[*] M77015.	1,5	0,75	1,5	[*] M77025.	0,5	0	0,5	[*] M770A5.
125/5	1,5	1	1,5	[*] M77016.	1,5	0,75	1,5	[*] M77026.	0,75	0,5	0,75	[*] M770A6.
150/5	2,5	2	2,5	[*] M77017.	1,5	1	1,5	[*] M77027.	1	0,5	1	[*] M770A7.
200/5	3,5	3	3,5	[*] M77018.	2,5	2	2,5	[*] M77028.	1,5	1	1,5	[*] M770A8.
250/5					2,5	2	2,5	[*] M77029.	2	1,5	2	[*] M770A9.
300/5									1,5	1	1,5	[*] M770AA.
400/5									2,5	2	2,5	[*] M770AB.
500/5									5	2	5	[*] M770AC.
600/5									5	2	5	[*] M770AD.

For other configurations see table of additional features





TABLE OF ADDITIONAL FEATURES

TD, TDH				
M	7	X	X	X
Code				
Secondary				



Delivery time: [*] Immediate, [x] working weeks, [c] Consult

NEW

TDH, High precision current transformer



Type	TDH6.2				TDH6				TDH8			
												
	width x height x depth (mm) 66 x 91 x 53				width x height x depth (mm) 66 x 91 x 53				width x height x depth (mm) 85 x 109 x 59			
ø (mm)	25				28				43			
Flat strip(mm)	25 x 12 30 x 10 20 x 20				20 x 25 30 x 15 40 x 10				50 x 30 60 x 12 13 x 45			
A	Class / VA				Class / VA				Class / VA			
	0.2	0.2S	0.5S	Code	0.2	0.2S	0.5S	Code	0.2	0.2S	0.5S	Code
100/5	1	0,5	1	[*] M77055.								
125/5	2	1	2	[*] M77056.								
150/5	3	1,5	3	[*] M77057.	1	0,5	1	[*] M77047.				
200/5	3,5	2,5	3,5	[*] M77058.	2	1	2	[*] M77048.				
250/5	3,5	2,5	3,5	[*] M77059.	2,5	1,5	2,5	[*] M77049.				
300/5	7,5	5	7,5	[*] M7705A.	3,5	2,5	3,5	[*] M7704A.	2	1	2	[*] M7706A.
400/5	7,5	5	7,5	[*] M7705B.	3,5	2,5	3,5	[*] M7704B.	2	1	2	[*] M7706B.
500/5	7,5	5	7,5	[*] M7705C.	5	3,5	5	[*] M7704C.	3,5	2	3,5	[*] M7706C.
600/5	7,5	5	7,5	[*] M7705D.	5	3,5	5	[*] M7704D.	3,5	2	3,5	[*] M7706D.
750/5					5	3,5	5	[*] M7704E.	3,5	2	3,5	[*] M7706E.
800/5					5	3,5	5	[*] M7704F.	3,5	2	3,5	[*] M7706F.
1000/5									5	3,5	5	[*] M7706G.
1200/5									5	3,5	5	[*] M7706H.
1250/5									7,5	5	7,5	[*] M7706J.
1500/5									7,5	5	7,5	[*] M7706K.
1600/5									7,5	5	7,5	[*] M7706L.

For other configurations see table of additional features

Type	TDH10				TDH12			
								
	width x height x depth (mm) 108 x 131 x 69				width x height x depth (mm) 134 x 151 x 69			
ø (mm)	63				50			
Flat strip(mm)	50 x 50 60 x 30 80 x 30				100 x 50			
A	Class / VA				Class / VA			
	0.2	0.2S	0.5S	Code	0.2	0.2S	0.5S	Code
600/5	3,75	2,5	3,75	[*] M7707D.				
750/5	3,75	2,5	3,75	[*] M7707E.				
800/5	3,75	2,5	3,75	[*] M7707F.	2,5	0	2,5	[*] M7708F.
1000/5	3,75	2,5	3,75	[*] M7707G.	2,5	1,25	2,5	[*] M7708G.
1200/5	3,75	2,5	3,75	[*] M7707H.	5	3,5	5	[*] M7708H.
1250/5	3,75	2,5	3,75	[*] M7707J.	5	3,5	5	[*] M7708J.
1500/5	7,5	5	7,5	[*] M7707K.	7,5	5	7,5	[*] M7708K.
1600/5	7,5	5	7,5	[*] M7707L.	7,5	5	7,5	[*] M7708L.
2000/5	7,5	5	7,5	[*] M7707M.	10	7,5	10	[*] M7708M.
2500/5	7,5	5	7,5	[*] M7707N.	10	7,5	10	[*] M7708N.
3000/5	7,5	5	7,5	[*] M7707P.	15	10	15	[*] M7708P.
4000/5					20	15	20	[*] M7708Q.

For other configurations see table of additional features

TQR, Current transformers split core

Type	TQR-8				TQR-10			
								
	width x height x depth (mm) 216 x 173 x 43.1				width x height x depth (mm) 240 x 198.71 x 43.41			
ø (mm)	80				105			
Flat strip(mm)								
A	Class / VA				Class / VA			
	0,5	1	3	Code	0,5	1	3	Code
400/5	-	1,5	3	[*] M76037.				
500/5	1	1,5	3	[*] M76039.				
600/5	1,5	2	4	[*] M7603B.	1,5	2	4	[C] M7604B.
700/5	2	4	8	[*] M7603D.	2	4	8	[C] M7604D.
750/5	2,5	5	10	[C] M7603E.	2,5	5	10	[C] M7604E.
800/5	3	7	15	[*] M7603F.	3	7	15	[C] M7604F.
1000/5	5	8	16	[*] M7603J.	5	8	16	[C] M7604J.
1250/5	6	10	20	[*] M7603L.	6	10	20	[C] M7604L.
1500/5	6	10	20	[*] M7603M.	6	10	20	[C] M7604M.
2000/5	8	15	25	[*] M7603N.	8	15	25	[C] M7604N.

For other configurations see table of additional features

STQ, Current transformers, split core



Type	STQ-24								
	Size (mm) width x height x depth 43.2x53x								
Secondary	5 A			1 A			250 mA		
A	Class	VA	Code	Class	VA	Code	Class	VA	Code
50							3	0,1	[C] M7371200A0000
100	3	1	[C] M73715.	3	1	[C] M737150010000	3	0,1	[C] M7371500A0000
150	3	1	[C] M73717.	3	1	[C] M737170010000	3	0,1	[C] M7371700A0000
200	3	1	[C] M73718.	3	1	[C] M737180010000	3	0,1	[C] M7371800A0000
250	1	1	[C] M73719.	1	1	[C] M737190010000	1	0,1	[C] M7371900A0000
300	1	1	[C] M7371A.	1	1	[C] M7371A0010000	1	0,1	[C] M7371A00A0000

TABLE OF ADDITIONAL FEATURES

TQR											
M	7	X	X	X	X	0	0	X	X	X	
Code	Internal code							↑	↑	Delivery time	+ €
Secondary	Standard (.../ 5 A)							0		-	-
	.../ 1 A							1		1	+20%
	.../250 mA							A		1	+30%
	.../100 mA							7		Consult	+40%
								0			
	IP 65 (1 m)							1			+30%+2€
	IP 65 (2 m)							2			+30%+4€
	IP 65 (3 m)							3			+30%+6€
IP65 protection (cable meters)	IP 65 (4 m)							4			+30%+8€
	IP 65 (5 m)							5			+30%+10€
Only TQR-8	IP 65 (6 m)							6			+30%+12€
	IP 65 (7m)							7			+30%+14€
	IP 65 (8 m)							8			+30%+16€
	IP 65 (9 m)							9			+30%+18€
	IP 65 (10 m)							A			+30%+20€

(*) A certificate is attached for every transformer



TA210, Current transformers, winding primary

Type				
				
	width x height x depth (mm) 75 x 104.5 x 134			
Flat strip(mm)				
A	Class / VA			
	0.5	1	3	Code
5/5	15	20	30	[*] M70541.
10/5	15	20	30	[*] M70542.
15/5	15	20	30	[*] M70543.
20/5	15	20	30	[*] M70544.
25/5	15	20	30	[*] M70545.
30/5	15	20	30	[*] M70546.
40/5	15	20	30	[*] M70547.
50/5	15	20	30	[*] M70548.
60/5	15	20	30	[*] M70549.
75/5	15	20	30	[*] M7054A.
80/5	15	20	30	[1] M7054K.
100/5	15	20	30	[*] M7054B.
125/5	15	20	30	[*] M7054C.
150/5	15	20	30	[*] M7054D.
200/5	10	20	30	[*] M7054E.
250/5	15	20	30	[*] M7054F.
300/5	15	20	30	[*] M7054G.
400/5	15	20	30	[*] M7054H.

Sealable terminal cover and anchoring base included

TA	M	7	X	X	X	X	0	0	X		
Code	Internal code							↑	Delivery time	+ €	
Secondary	Standard (.../ 5 A)							0	-	-	
	.../ 1 A							1	1	Consult	
	.../250 mA							A	1	Consult	

TA, Current transformers

Type	TA400				TA500				TA600			
												
	width x height x depth (mm) 95 x 165 x 59				width x height x depth (mm) 115 x 185 x 63				width x height x depth (mm) 124 x 192 x 62			
Flat strip(mm)	100 x 20				100 x 30				125 x 60			
A	Class / VA				Class / VA				Class / VA			
	0.5	1	3	Code	0.5	1	3	Code	0.5	1	3	Code
300/5	5	10	15	[3] M7059A.								
400/5	5	10	15	[3] M70591.								
500/5	15	20	30	[3] M70592.								
600/5	15	20	30	[3] M70593.								
750/5	15	20	30	[*] M70594.								
800/5	15	20	30	[*] M70595.					15	15	-	[3] M705BB.
1000/5	15	20	30	[*] M70596.	15	20	30	[3] M705A2.	15	20	30	[*] M705B1.
1200/5	15	20	30	[*] M70597.	15	20	30	[3] M705A3.	15	20	30	[3] M705B2.
1500/5	15	30	40	[*] M70598.	15	30	40	[*] M705A4.	15	20	30	[*] M705B3.
2000/5	20	40	50	[*] M70599.	20	40	50	[*] M705A6.	15	20	30	[*] M705B5.
2500/5	20	40	50	[C] M7059B.	20	40	50	[*] M705A7.	20	30	40	[*] M705B6.
3000/5					20	45	60	[*] M705A8.	30	40	60	[*] M705B7.
3200/5									30	40	60	[3] M705BA.
4000/5					35	50	70	[*] M705A9.	35	50	70	[*] M705B8.
5000/5									40	60	80	[*] M705B9.

For other configurations see table of additional features

kit3-TRMC210 Kit of 3 current transformers for energy meters, primary winding

Type	kit3-TRMC210			kit3-TRMC210-05			kit3-TRMC210.2		
	Size (mm) width x height x depth 145x110x86								
A	Class	VA	Code	Class	VA	Code	Class	VA	Code
100/5	0.5S	10	[3] Q309010000001	0.5	10	[3] Q309610000001	0.5S	2,5	[3] Q309810000001
150/5	0.5S	10	[3] Q309020000001	0.5	10	[3] Q309620000001	0.5S	2,5	[3] Q309820000001
200/5	0.5S	10	[3] Q309030000001	0.5	10	[3] Q309630000001	0.5S	2,5	[3] Q309830000001
300/5	0.5S	10	[3] Q309040000001	0.5	10	[3] Q309640000001	0.5S	2,5	[3] Q309840000001
400/5	0.5S	10	[3] Q309050000001	0.5	10	[3] Q309650000001	0.5S	2,5	[3] Q309850000001
500/5	0.5S	10	[3] Q309060000001	0.5	10	[3] Q309660000001	0.5S	2,5	[3] Q309860000001
600/5	0.5S	10	[3] Q309070000001	0.5	10	[3] Q309670000001	0.5S	2,5	[3] Q309870000001

Consulter disponibilité.../1 A

kit3-TRMC400 Sets of 3 current transformers for energy meters

Type	kit3-TRMC400			kit3-TRMC400-05			kit3-TRMC400.2		
	Size (mm) width x height x depth 99x160x68								
Flat strip(mm)	100x20 mm								
A	Class	VA	Code	Class	VA	Code	Class	VA	Code
750/5	0.5S	10	[3] Q309110000001	0.5	10	[3] Q309710000001	0.5S	2,5	[3] Q309A10000001
1000/5	0.5S	10	[3] Q309120000001	0.5	10	[3] Q309720000001	0.5S	2,5	[3] Q309A20000001
1500/5	0.5S	10	[3] Q309130000001	0.5	10	[3] Q309730000001	0.5S	2,5	[3] Q309A30000001
2000/5	0.5S	10	[3] Q309140000001	0.5	10	[3] Q309740000001	0.5S	2,5	[3] Q309A40000001
3000/5							0.5S	2,5	[3] Q309A60000001

Consulter disponibilité.../1 A



TRMCx3, Current transformers for energy meters

Type	Code	Measurement Range (A)	Class 0,5S Power (VA)	Usefull diam.(mm)	Cable (m)
Outdoor					
TRMC-X3 100/5 Ext	[C] Q301T1010E000	100/5	2.5	38	7
TRMC-X3 200/5 Ext	[C] Q301T2010E000	200/5	2.5	38	7
TRMC-X3 300/5-Ext	[C] Q301T3010E000	300/5	2.5	38	7
TRMC-X3 400/5 Ext	[C] Q301T4010E000	400/5	2.5	38	7

TABLE OF ADDITIONAL FEATURES

TRM				
P	5	X	X	X
				X
Code	Internal code	Delivery time	+ €	
		↑		
Secondary	Standard (.../ 5 A)	0	-	-
	... / 1A	1	3	+20 %



TRM, Measuring transformers encapsulated in resin

Type	TRM30			TRM40			TRM60		
	Size (mm) width xheight xdepth 50x110x30			Size (mm) width xheight xdepth 38x135x40			Size (mm) width xheight xdepth 36x135x60		
Flat strip(mm)	30 mm			40 mm			60 mm		
Secondary	5 A								
A	Class	VA	Code	Class	VA	Code	Class	VA	Code
75	1	2	[4] P50101.						
100	1	5	[4] P50102.						
150	1	5	[4] P50103.	0.5	5	[4] P50111.			
200	0.5	10	[4] P50104.	0.5	7,5	[4] P50112.			
250	0.5	15	[4] P50105.	0.5	10	[4] P50113.	0.5	5	[4] P50121.
300	0.5	20	[4] P50106.	0.5	15	[4] P50114.	0.5	7,5	[4] P50122.
400	0.5	25	[4] P50107.	0.5	20	[4] P50115.	0.5	10	[4] P50123.
500				0.5	25	[4] P50116.	0.5	15	[4] P50124.
600				0.5	30	[4] P50117.	0.5	20	[4] P50125.
800				0.5	35	[4] P50118.	0.5	25	[4] P50126.
1000							0.5	30	[4] P50127.
1200							0.5	35	[4] P50128.

Type	TRM80			TRM100		
	Size (mm) width xheight xdepth 36x135x80			Size (mm) width xheight xdepth 38x175x100		
Flat strip(mm)	80 mm			100 mm		
Secondary	5 A					
A	Class	VA	Code	Class	VA	Code
500	0.5	5	[4] P50131.			
600	0.5	7,5	[4] P50132.			
750	0.5	10	[4] P50133.	0.5	15	[4] P50141.
1000	0.5	15	[4] P50134.	0.5	20	[4] P50142.
1500	0.5	20	[4] P50135.	0.5	20	[4] P50144.
2000	0.5	25	[4] P50136.	0.5	20	[4] P50145.
2500	0.5	30	[4] P50137.	0.5	20	[4] P50146.
3000				0.5	25	[4] P50147.

Type	TRM140			TRM180		
	Size (mm) width xheight xdepth 40x223x140			Size (mm) width xheight xdepth 40x223x180		
Flat strip(mm)	140 mm			180 mm		
Secondary	5 A					
A	Class	VA	Code	Class	VA	Code
1000	0.5	15	[4] P50151.			
1250	0.5	20	[4] P50152.	0.5	15	[4] P50161.
1500	0.5	25	[4] P50153.	0.5	20	[4] P50162.
2000	0.5	30	[4] P50154.	0.5	20	[4] P50163.
2500	0.5	35	[4] P50155.	0.5	20	[4] P50164.
3000	0.5	35	[4] P50156.	0.5	20	[4] P50165.
4000	0.5	35	[4] P50157.	0.5	20	[4] P50166.
5000				0.5	20	[4] P50167.

SH, Shunts for direct current measurement

Type	SHP		SHB		SH	
						
Accuracy	1		0.5			
Relation	Type	Code	Type	Code	Type	Code
1A/60mV			SHB 1A/60mV	[3] M71221.		
1.5A/60mV			SHB 1.5A/60mV	[3] M71222.		
2.5A/60mV			SHB 2.5A/60mV	[3] M71223.		
4A/60mV			SHB 4A/60mV	[3] M71224.		
5A/60mV			SHB 5A/60mV	[3] M71225.		
6A/60mV			SHB 6A/60mV	[3] M71226.		
10A/60mV			SHB 10A/60mV	[*] M71227.		
15A/60mV			SHB 15A/60mV	[*] M71228.		
25A/60mV			SHB 25A/60mV	[*] M71229.		
30A/60mV	SHP 30A/60mV	[3] M71211.	SHB 30A/60mV	[*] M7122A.	SH 30A/60mV	[*] M71231.
40A/60mV			SHB 40A/60mV	[*] M7122B.	SH 40A/60mV	[2] M71232.
50A/60mV	SHP 50A/60mV	[3] M71213.	SHB 50A/60mV	[*] M7122C.	SH 50A/60mV	[*] M71233.
60A/60mV	SHP 60A/60mV	[3] M71214.	SHB 60A/60mV	[*] M7122D.	SH 60A/60mV	[*] M71234.
75A/60mV	SHP 75A/60mV	[3] M71215.				
80A/60mV			SHB 80A/60mV	[*] M7122E.	SH 80A/60mV	[*] M71235.
100A/60mV	SHP 100A/60mV	[3] M71216.	SHB 100A/60mV	[*] M7122F.	SH 100A/60mV	[*] M71236.
150A/60mV	SHP 150A/60mV	[3] M71217.			SH 150A/60mV	[*] M71237.
200A/60mV	SHP 200A/60mV	[3] M71218.	SHB 200A/60mV	[2] M7122N.	SH 200A/60mV	[*] M71238.
250A/60mV					SH 250A/60mV	[*] M71239.
300A/60mV					SH 300A/60mV	[*] M7123A.
400A/60mV					SH 400A/60mV	[*] M7123B.
500A/60mV					SH 500A/60mV	[*] M7123C.
600A/60mV					SH 600A/60mV	[*] M7123D.
750A/60mV					SH 750A/60mV	[2] M7123E.
800A/60mV					SH 800A/60mV	[2] M7123F.
1000A/60mV					SH 1000A/60mV	[*] M7123G.
1200A/60mV					SH 1200A/60mV	[3] M7123H.
1500A/60mV					SH 1500A/60mV	[*] M7123J.
2000A/60mV					SH 2000A/60mV	[3] M7123K.
2500A/60mV					SH 2500A/60mV	[3] M7123L.
3000A/60mV					SH 3000A/60mV	[3] M7123M.
4000A/60mV					SH 4000A/60mV	[3] M7123N.
5000A/60mV					SH 5000A/60mV	[3] M7123P.
6000A/60mV					SH 6000A/60mV	[3] M7123Q.
7500A/60mV					SH 7500A/60mV	[3] M7123R.
8000A/60mV					SH 8000A/60mV	[C] M7123S.
10000A/60mV					SH 10000A/60mV	[C] M7123T.
12500A/60mV					SH 12500A/60mV	[C] M7123U.
15000A/60mV					SH 15000A/60mV	[C] M7123V.
18000A/60mV					SH 18000A/60mV	[C] M7123Z.
20000A/60mV					SH 20000A/60mV	[C] M7123O.

SHP: Faston connection; SHB: Insulating base socket(up to 100 A); SH: Without base

For other configurations see additional performance table.
All shunts are supplied with 1.5 m long cables with a 1.5 mm² cross-section

SHP / SHB / SH											
M	7	X	X	X	X	0	0	X	Internal code	Delivery time	+ €
Code											
									0	-	-
									1	2	+ 20%
									7	Consult	Consult
									2	2	+ 25%
									3	2	+ 25%
Outputs									4	2	+ 50%
									8	Consult	Consult
									5	Consult	Consult
									9	Consult	Consult
									6	Consult	Consult

Delivery time: [*] Immediate, [x] working weeks, [c] Consult



VT, Measurement voltage transformers

Type	Code	Class 0,5 Power (VA)	Class 1 Power (VA)	Relation
VT2311 230V/110V	[3] M72311.	10	25	230/110V
VT3823 380V/230V	[3] M72352.	10	25	380/230V
VT4011 400V/110V	[3] M72321.	10	25	400/110V
VT4023 400V/230V	[3] M72322.	10	25	400/230V
VT4411 440V/110V	[3] M72331.	10	25	440/110V
VT4423 440V/230V	[3] M72332.	10	25	440/230V
VT4811 480V/110V	[3] M72341.	10	25	480/110V
VT4823 480V/230V	[3] M72342.	10	25	480/230V
VT7011 700V/110V	[3] M72381.	10	25	700/110V
VT7023 700V/230V	[3] M72382.	10	25	700/230V

For three-phase networks, 3 units are required.
For other voltage ratios, please ask.



TSR, Current adding transformer

Type	Code	Input current	Class 0,5 Power (VA)	Class 1 Power (VA)	Measuring Channels
TSR-2	[*] M70701.	5 A	15	30	2
TSR-3	[*] M70702.	5 A	15	30	3
TSR-4	[*] M70703.	5 A	15	30	4
TSR-5	[*] M70704.	5 A	15	30	5

Current adding transformers must have the same primary ratio.
For three-phase networks, one transformer per phase is required.
It is fed from the same measure.
For other ratios, please ask.



TE, Impedance elevator transformer

Type	Code	Class 1 Power (VA)	Relation
TE-5/0.1	[*] M70911.	15	5 /0,1 A

It is used when the distance between the measuring equipment and the current transformer is very long. Two TE must be used, one next to the current transformer and the other next to the measuring equipment.



For Protection current transformers SEE SECTION Protection and Control/Protection current transformers

TABLE OF ADDITIONAL FEATURES

TSR							
M	7	X	X	X	0	0	X
Code	Internal code	Delivery time	+ €				
Secondary	Standard (.../ 5 A)	0	-	-			
	.../ 1 A	1	1	Consult			
	.../250 mA	A	1	Consult			

Dimensions

TD4 / TDH4

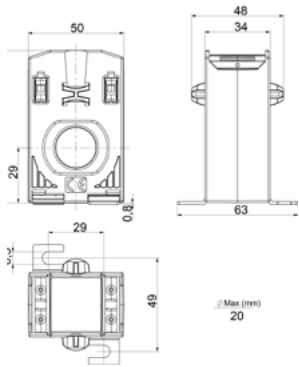

TD5 / TDH5

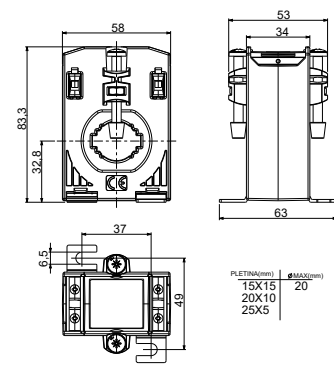

TD5.2 / TDH5.2

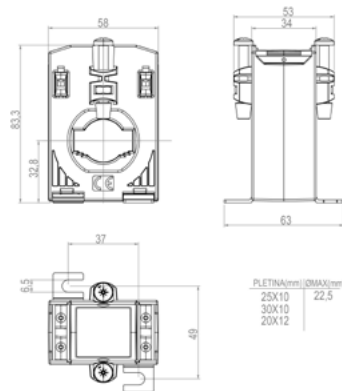

TD6 / TDH6

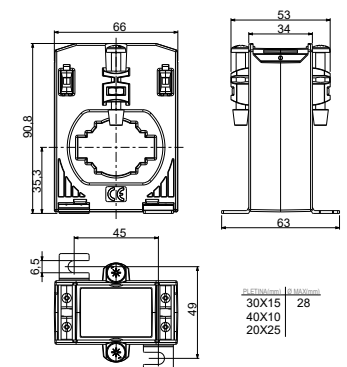

TD6.2 / TDH6.2

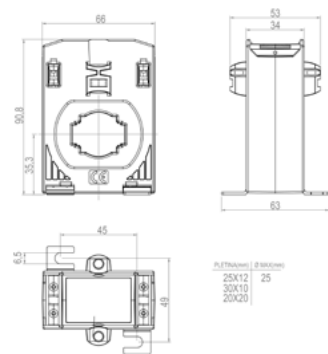

TD8 / TDH8

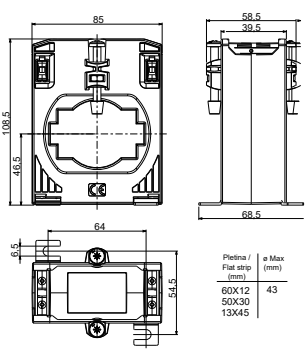

TD10 / TDH10

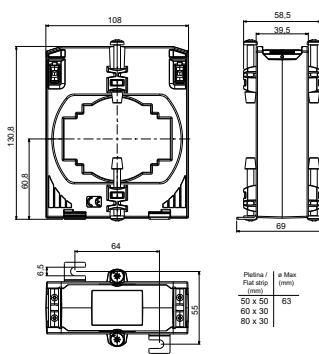

TD12 / TDH12

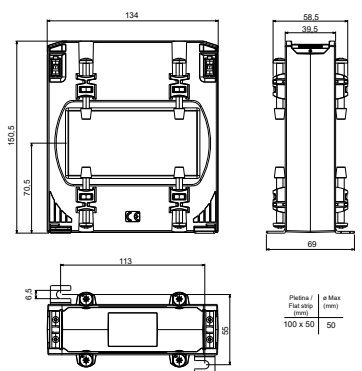

TQ-6

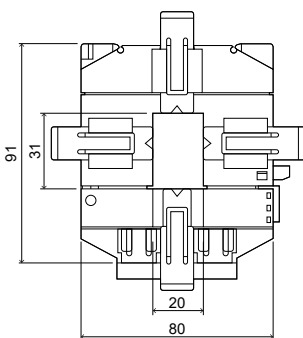

TQ-8

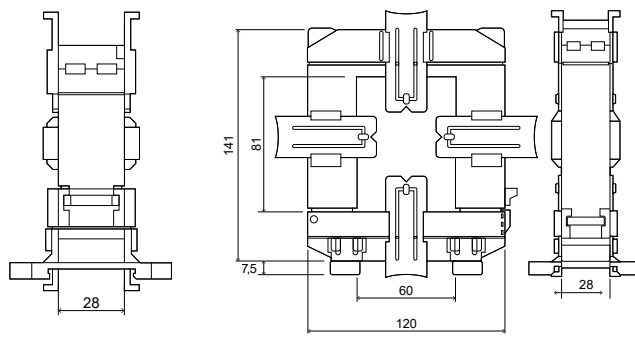

TQ-10

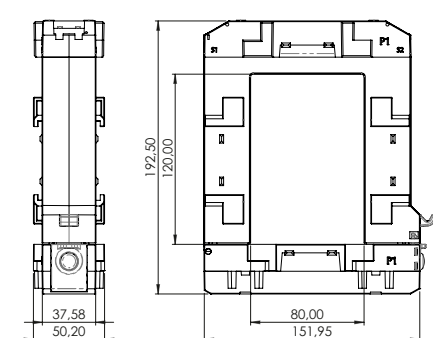

TQ-12

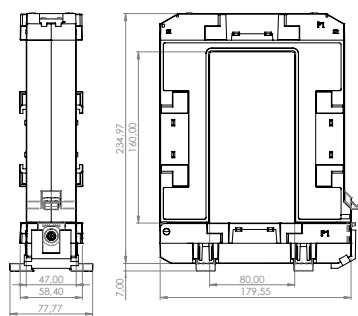

TQR-8

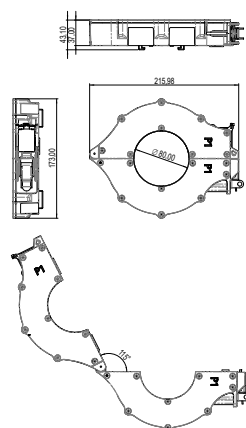

TQR-10

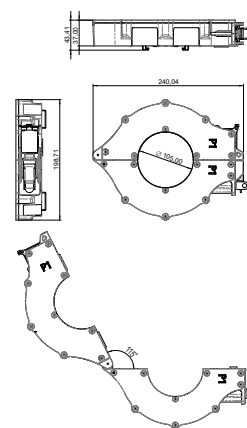

MC1

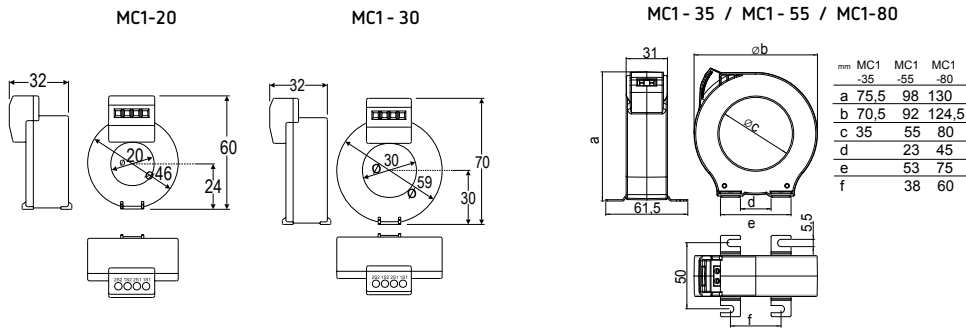

MC3

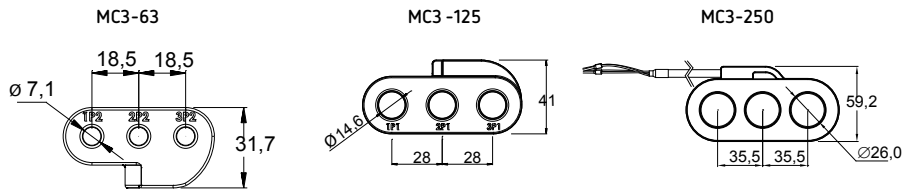

STQ-24

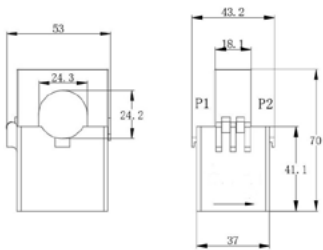

TRMCx3

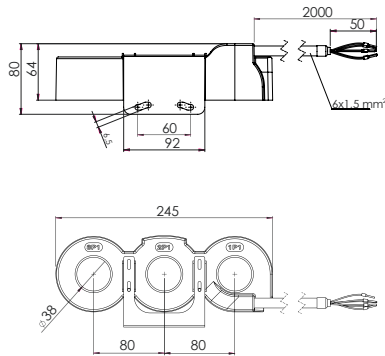

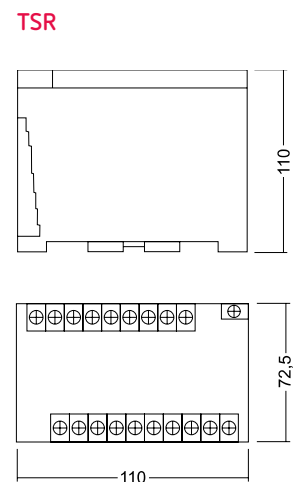
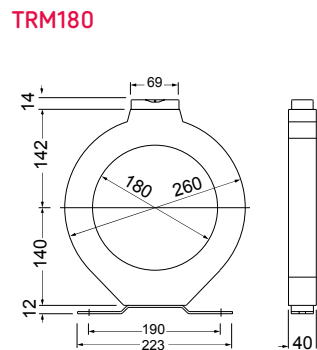
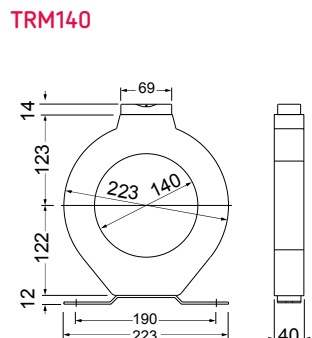
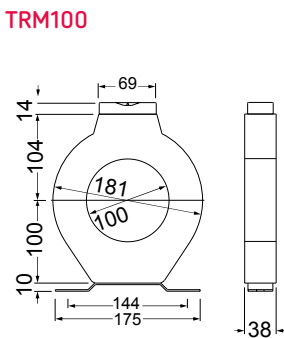
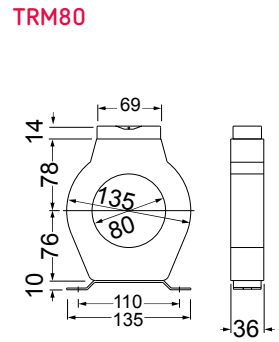
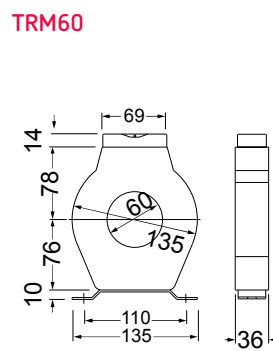
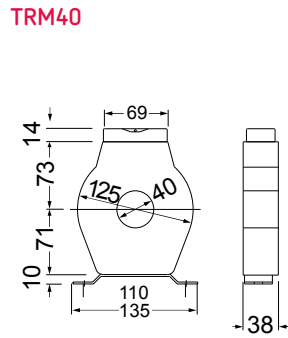
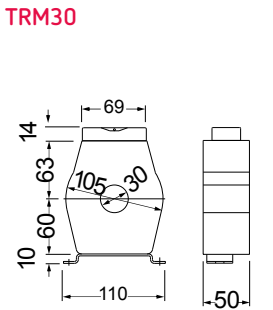
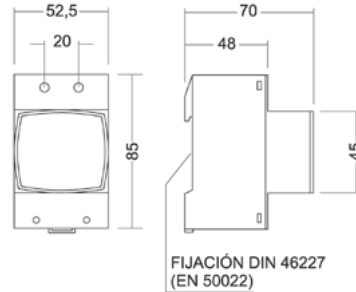
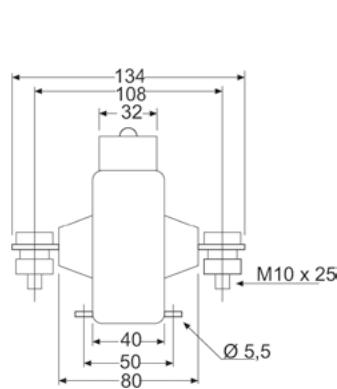
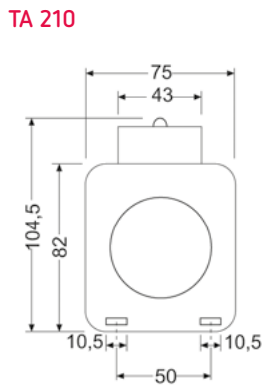
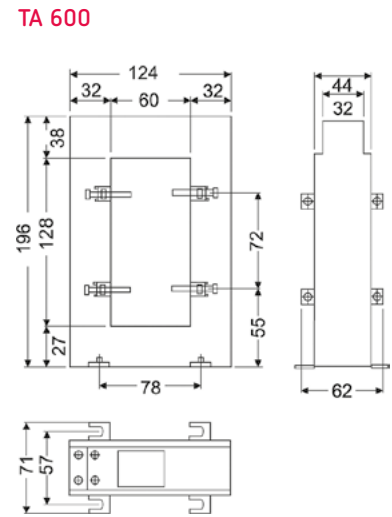
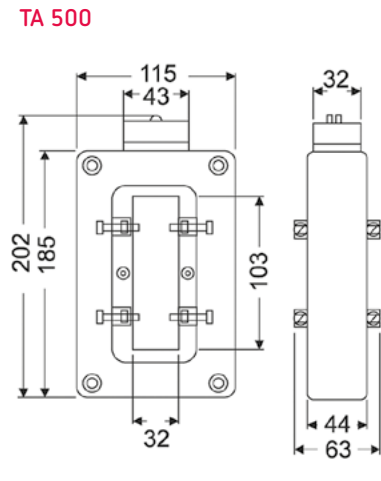
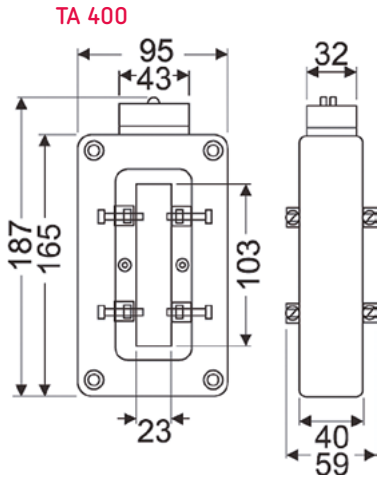

VT

Soporte de fijación

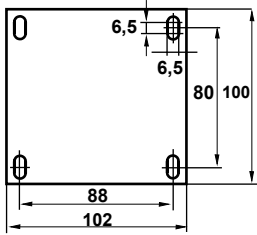

Dimensiones en mm.

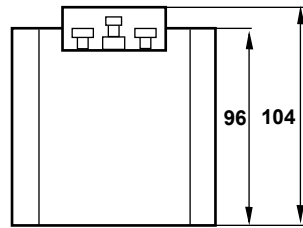
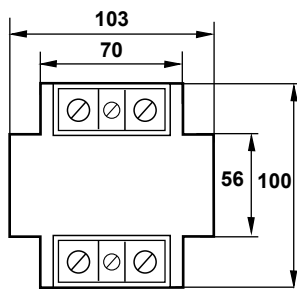

Shunts

Voltage drop $mV_{(1)}$	Range $A_{(1)}$	Fig.	a1	a2	b1	b2	b3	c1	c2	e	h	N° Current connections	Current connections			Voltage connections
													Hexagonal screws DIN 933	Washer DIN 125	DIN 934 nut	
60	1-1, 5-2, 5-4-6-10-15-25	1	90	28	20	-	-	8	-	78	-	2 x 1	M5 x 12	5,3	-	2 Screws M5 x 8 DIN 84 & 2 Washer 5,3 DIN 433
	30-40-60-100-150		100	33	20	-	-	8	-	80	-	2 x 1	M8 x 16	8,4	-	
	250	2	145	55	30	15	-	10	10	105	30	2 x 1	M12 x 40	13	M12	
	400-600				40	20	-	10	10	115	30	2 x 1	M16 x 45	17	M16	
	800				60	30	-	10	10	115	30	2 x 1	M20 x 50	21	M20	
	1500				90	21	48	10	10	115	30	2 x 2	M16 x 45	17	M16	
2500	120	30	60	10	10	115	30	2 x 2	M20 x 50	21	M20					
150	1-1, 5-2, 5-4-6-10-15-25	1	90	25	20	-	-	8	-	78	-	2 x 1	M5 x 12	5,3	-	2 Screws M5 x 8 DIN 84 & 2 Washer 5,3 DIN 433
	40-60-100-150		225	33	25	-	-	8	-	205	-	2 x 1	M8 x 16	8,4	-	
	250	2	270	55	30	15	-	10	10	230	50	2 x 1	M12 x 40	13	M12	
	400-600				40	20	-	10	10	240	60	2 x 1	M16 x 45	17	M16	
	800				70	35	-	10	10	240	60	2 x 1	M20 x 50	21	M20	

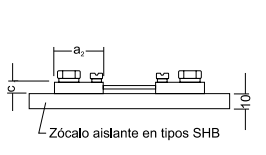

SHUNT 1-150

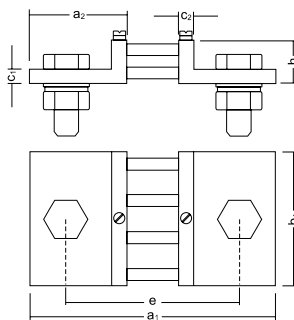

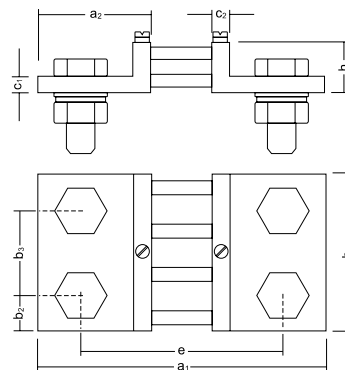

SHUNT 200-1000



SHUNT 1500-2500

Portable power analyzers

Table: Portable power analyzers

		MYeBOX-A	MYeBOX 1500-4G	MYeBOX 150
				
Connection	Single-phase	•	•	•
	Three-phase	•	•	•
Parameters	Voltage	•	•	•
	Current	•	•	•
	Neutral current	•	•	•
	Leakage current	•	•	–
	Neutral-earth voltage	•	•	–
	Power	•	•	•
	Energy (active and reactive)	•	•	•
	Harmonics	•	•	•
	Flicker	•	•	•
	Quality parameter measurements	Events (overvoltages, gaps and interruptions)	•	•
EN50160 parameters		•	•	•
Transients		•	•	•
Inputs/outputs	Digital inputs	2	2	–
	Digital outputs	2	2	–
Other features	Memory	•	•	•
	Communications	WiFi 4G µUSB	WiFi 4G µUSB	WiFi µUSB
	Display	LCD	LCD	LCD
	Display of parameters	Display Smartphone & tablet (APP) Software + cloud	Display Smartphone & tablet (APP) Software + cloud	Display Smartphone & tablet (APP) Software + cloud
	Display of files	Smartphone & tablet (APP) Software + cloud	Smartphone & tablet (APP) Software + cloud	Smartphone & tablet (APP) Software + cloud
	Standards	Measuring in accordance with IEC 61000-4-30	Class A certified	According Class A
T - Depending on Type				



MYeBOX-A, Portable power analyzer with recording of quality events and transients Calibration Certificate (IEC 61000-4-30 Ed.2) Class A Certificate extended by CIRCUTOR ENAC laboratory

Type	Code	Clamp	Measuring Channels	Transistor output	Digital inputs	Communications
Portable analyzer kits with current sensors						
MYeBOX-1500-4G	[2] M844330000A00	-	5	2	2	Wi-Fi 4G
MYeBOX-1500-4G + 3 FLEX-R45	[2] M8445B0000A00	3 FLEX-R45	5	2	2	Wi-Fi 4G
MYeBOX-1500-4G + 4 FLEX-R45	[2] M8445C0000A00	4 FLEX-R45	5	2	2	Wi-Fi 4G
MYeBOX-1500-4G + 3 FLEX-R80	[2] M8445D0000A00	3 FLEX-R80	5	2	2	Wi-Fi 4G
MYeBOX-1500-4G + 4 FLEX-R80	[2] M8445E0000A00	4 FLEX-R80	5	2	2	Wi-Fi 4G
MYeBOX-1500-4G + 3 CPG-100	[2] M844530000A00	3 CPG-100	5	2	2	Wi-Fi 4G
MYeBOX-1500-4G + 3 CPRG-500	[2] M844550000A00	3 CPRG-500	5	2	2	Wi-Fi 4G

Analyser with built-in SD memory and Cloud Includes voltage cables, alligator clips, USB cable, fastening strap, magnetic support, battery, power supply and carrying bag. Please contact us for other clamp or clamp length combinations



MYeBOX, Portable power analyzer with recording of quality events and transients in accordance with (IEC 61000-4-30 Ed.2) Class A

Type	Code	Clamp	Measuring Channels	Transistor output	Digital inputs	Communications
MYeBOX-150	[*] M84023.	-	4	-	-	Wi-Fi
MYeBOX-1500-4G	[*] M84433.	-	5	2	2	Wi-Fi 4G

Portable analyzer kits with current sensors

MYeBOX-150+3 FLEX-R45	[*] M8404B.	3 FLEX-R45	4	-	-	Wi-Fi
MYeBOX-1500-4G + 3 FLEX-R45	[*] M8445B.	3 FLEX-R45	5	2	2	Wi-Fi 4G
MYeBOX-150-4 FLEX-R45	[*] M8404C.	4 FLEX-R45	4	-	-	Wi-Fi
MYeBOX-1500-4G + 4 FLEX-R45	[*] M8445C.	4 FLEX-R45	5	2	2	Wi-Fi 4G
MYeBOX-150-3 FLEX-R80	[*] M8404D.	3 FLEX-R80	4	-	-	Wi-Fi
MYeBOX-1500-4G + 3 FLEX-R80	[*] M8445D.	3 FLEX-R80	5	2	2	Wi-Fi 4G
MYeBOX-150-4 FLEX-R80	[*] M8404E.	4 FLEX-R80	4	-	-	Wi-Fi
MYeBOX-1500-4G + 4 FLEX-R80	[*] M8445E.	4 FLEX-R80	5	2	2	Wi-Fi 4G
MYeBOX-150 + 3 CPG-100	[*] M84043.	3 CPG-100	4	-	-	Wi-Fi
MYeBOX-1500-4G + 3 CPG-100	[*] M84453.	3 CPG-100	5	2	2	Wi-Fi 4G
MYeBOX-150 + 3 CPRG-500	[*] M84045.	3 CPRG-500	4	-	-	Wi-Fi
MYeBOX-1500-4G + 3 CPRG-500	[*] M84455.	3 CPRG-500	5	2	2	Wi-Fi 4G

Analyser with built-in SD memory and Cloud Includes voltage cables, alligator clips, USB cable, fastening strap, magnetic support, battery, power supply and carrying bag. Please contact us for other clamp or clamp length combinations

Type	Code	Description
V-Wire x3	[*] M8401B.	set of 3 600 V CAT III cables
V-Wire x4	[*] M8401C.	set of 4 600 V CAT III cables
V-Wire x5	[*] M8401D.	set of 5 600 V CAT III cables
MYeBOX-BAT	[*] M84011.	MYEBOX battery
	[*] M8441F.	MYEBOX power cable
MYeBOX-PSN480	[*] M8441A.	MYEBOX power supply (480 V)
MYeBOX-MARKER	[*] M84014.	Markers
MYeBOX-CARRYING BAG	[*] M84015.	Carrying bag
MYeBOX-BELT	[*] M84016.	MYEBOX strap
MYeBOX-MAG SUPPORT	[*] M84017.	MYEBOX magnetic base

Type	Code	Description
VCC-1	[*] M89909.	Crocodile clamp (1 unit)
MAG-ADAP	[*] M8990H.	Voltage adapter, magnetic tip Ø 6.6 mm
MAG-ADAPx3	[*] M8990J.	Kit 3 voltage adapters, magnetic tip Ø 6.6 mm
MAG-ADAPx4	[*] M8990K.	Kit 4 voltage adapters, magnetic tip Ø 6.6 mm
MAG-ADAPx5	[*] M8990L.	Kit 5 voltage adapters, magnetic tip Ø 6.6 mm

TABLE OF ADDITIONAL FEATURES

MYeBOX			
M	8	4	0
X	X	0	0
0	0	0	0
X	X	X	X
Code	Internal code	↑	Delivery time
class A calibration certificate	A	↑	2
MYeBOX kit with rugged IP clamps for outdoor use		0 2	4

FLEX-R			
M	8	1	6
X	X	0	0
0	0	0	0
X	0	X	X
Code	internal code	↑	Delivery time
REDEL connector (PFG.M0.4GL. AC52GZ+protection (GMA.1B.054.DG)		2	1
Rugged IP for outdoor use		0 1	4



FLEX-R Flexible sensors for MYeBOX analysers

Type	I min (A)	Measurement Range (A)	∅ (mm)	Sensor lenght	Nr Sensors	Code	Nr Sensors	Code	Nr Sensors	Code
FLEX-R45	1 10 500	10 ... 100 A /	140	45 cm	1	[*] M81611.	3	[*] M81631.	4	[*] M81641.
FLEX-R80		100 ... 1000 A /	250	80 cm	1	[*] M81612.	3	[*] M81632.	4	[*] M81642.
FLEX-R120		1000 ... 10000 A	380	120 cm	1	[*] M81613.	3	[*] M81633.	4	[*] M81643.



FLEX-RMG Flexible sensors for MYeBOX analysers

Type	I min (A)	Measurement Range (A)	∅ (mm)	Sensor lenght	Nr Sensors	Code	Nr Sensors	Code	Nr Sensors	Code
FLEX-RMG70	1 10 500	10 ... 100 A /	70	22 cm	1	[*] M81911.	3	[*] M81931.	4	[*] M81941.
FLEX-RMG120		100 ... 1000 A / 1000 ... 10000 A	120	38 cm	1	[*] M81912.	3	[*] M81932.	4	[*] M81942.



CPG Clamps

Type	I min (A)	Measurement Range (A)	∅ (mm)	Nr Sensors	Code	Nr Sensors	Code	Nr Sensors	Code
CPG-5	0.05	0,05 ... 5 A	20	1	[*] M810B1.	3	[*] M810C1.	4	[*] M810D1.
CPG-100		1 ... 100 A		1	[*] M810B2.	3	[*] M810C2.	4	[*] M810D2.
CPRG-500	1	1 ... 500 A	52	1	[*] M810B3.	3	[*] M810C3.	4	[*] M810D3.
CPRG-1000		1 ... 1000 A		1	[*] M810B4.	3	[*] M810C4.	4	[*] M810D4.
CPRG-200/2000	1 10	1 ... 200 A / 10 ... 2000 A	64	1	[*] M810B5.	3	[*] M810C5.	4	[*] M810D5.



CFG, Residual current sensors (leaks)

Type	Code	Measurement Range (A)	I min	Usefull diam.(mm)	Flat strip(mm)
CFG-5	[3] M810BD.	0,01 ... 5 A	0.01	52	1 - 50 x 5 4 - 30 x 5
CFG-10	[*] M810BE.	0,005 ... 10 A	0.005	100	5 - 80 x 5 3 - 80 x 10

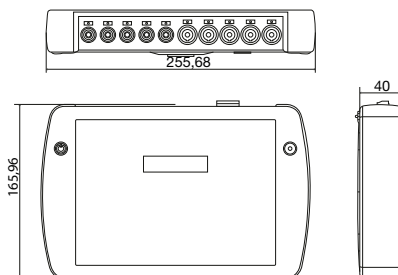

Dimensions

MYeBOX



Digital instruments

Table: Digital instruments selection

		DCB	DHC-96	DCP-96
				
Mounting	Pannel	72 x 72	96 x 48	96 x 96
	DIN rail	-	-	-
AC measurement	Single-phase	●	●	●
	Three-phase	-	-	●
AC measurement Parameters	Voltage	DCB-xx-Vac	DHC-96 Vac	DCP-96 Vac
	Current	DCB-xx-Aac	DHC-96 Aac	DCP-96 Aac
	Active power (W)	-	-	-
	Frequency (Hz)	DCB-xx-Vac / DCB-xx-Aac	DHC-96 Vac DHC-96 Aac	●
	Maximum demand (A)	-	-	-
	DC measurement Parameters	Voltage	DCB-xx-HVdc	DHC-96 Vdc DHC-96 CPM DHC-96 CPM HS DHC-96 HVdc DHC-96 CPM 1500
	Voltage (mV) - Indirect current mV Shunt	DCB-xx-mVdc	DHC-96 mVdc DHC-96 CPM DHC-96 CPM 1500	-
	Current	DCB-xx-Adc	DHC-96 Adc	-
	Process signal (±10 V)	DCB-xx-LVdc	DHC-96 LVdc DHC-96 Vdc	-
	Process signal (mA)	DCB-xx-mAdc	DHC-96 mAdc	-
Accuracy	0,5%	●	●	●
Other options	Auxiliar output relay	DCB-72xx-20R	2	-
	Analog output	-	1	-
	Transistor input	-	2	-
	Communications port	-	RS-485 (Modbus RTU)	-
	Auxiliar power supply	80...270 Vca/Vcc 18...36 Vcc	80...270 Vca/Vcc 18...36 Vcc (OP) 20... 60 Vdc (OP)	80...270 Vca
	Frontal adapter	●	●	-

OP - Opcional / T - Depending on the type



DCB Digital instrument

80 ... 270 Vac /Vdc power supply voltage

Type	Code	System	Measurement Range U	Measurement Range I	Output relay	Size(mm)
Voltmeters						
DCB-72 LVdc-20R	[*] M22222.	DC	± 10 Vdc	-	2	72 x 72
DCB-72 HVdc-20R	[*] M22232.	DC	± 1500 Vdc	-	2	72 x 72
Ammeters						
DCB-72 Aac-20R	[*] M22252.	AC	-	.../5 A .../1 A	2	72 x 72
DCB-72 Adc-20R	[*] M22272.	DC	-	1 Adc 5 Adc	2	72 x 72
Process indicators						
DCB-72 mVdc-20R	[*] M22242.	DC	200 mV	-	2	72 x 72
DCB-72 mAdc-20R	[*] M22262.	DC	-	-20... +20 mA	2	72 x 72

TABLE OF ADDITIONAL FEATURES

DCB	
Code	Internal Code
M 2 X X X X 0 0 X	
	↑ Delivery time
Auxiliary supply	Standard (80... 270 V _{ac}) 0
	18 ... 36 V _{dc} 3 -



DHC-96 Digital instruments 96 x 48

80 ... 270 Vac /Vdc power supply voltage

Type	Code	System	Parameters	Measurement Range U	Measurement Range I	Output relay	Digital inputs	Analog output	Communications	Protocol
Voltmeters										
DHC-96 Vac	[*] M22318.	AC	V ~	480 V	-	2	2	1 (20 mA)	RS-485	Modbus/RTU
DHC-96 Vdc	[*] M22388.	DC	V dc	± 10 Vdc ± 24 Vdc ± 48 Vdc	-	2	2	1 (20 mA)	RS-485	Modbus/RTU
DHC-96 HVdc	[*] M22338.	DC	V dc	± 1500 Vdc	-	2	2	1 (20 mA)	RS-485	Modbus/RTU
Ammeters										
DHC-96 Aac	[*] M22358.	AC	A ~	-	.../5 A .../1 A	2	2	1 (20 mA)	RS-485	Modbus/RTU
DHC-96 Adc	[*] M22378.	DC	A dc	-	1 Adc 5 Adc	2	2	1 (20 mA)	RS-485	Modbus/RTU
DHC-96 mVdc	[*] M22348.	DC	V dc	-	200 mV	2	2	1 (20 mA)	RS-485	Modbus/RTU
Process indicators										
DHC-96 LVdc	[*] M22328.	DC	V dc	± 10 Vdc	-	2	2	1 (20 mA)	RS-485	Modbus/RTU
DHC-96 mA dc	[*] M22368.	DC	mA dc	-	-20... +20 mA	2	2	1 (20 mA)	RS-485	Modbus/RTU

Option of 0/2... 10 VDC outputs on demand



DHC-96 CPM Digital instruments: Programmable DC measurement Central

100... 270 Vac /Vdc power supply voltage

Type	Code	System	Parameters	Measurement Range U	Measurement Range I	Output relay	Digital inputs	Analog output	Communications	Protocol
Multimeter										
DHC-96 CPM	[*] M223A8.	DC (Shunt)	V/A/kW/kWh	± 600 Vdc	600 mV	2	2	1 (20 mA)	RS-485	Modbus/RTU
DHC-96 CPM-HS	[C] M223B8.	DC (Hall)	V/A/kW/kWh	± 600 Vdc	4 Vdc	2	2	1 (20 mA)	RS-485	Modbus/RTU
DHC-96 CPM 1500	[*] M223C8.	DC (Shunt)	V/A/kW/kWh	± 1500 Vdc	600 mV	2	2	1 (20 mA)	RS-485	Modbus/RTU

Option of 0/2... 10 VDC outputs on demand



DCP-96 Digital instruments 96 x 96

80...270 Vac / Vdc power supply voltage.

Type	Code	System	Parameters	Measurement Range U	Measurement Range I
DCP-96 VAC	[2] M22410.	AC	V, Hz	3 x 230 400 V	-
DCP-96 AAC	[2] M22450.	AC	A, Hz	-	.../5 A .../1 A

Front adapter

Type	Code	Description
Adap.Frontal 72x72 -> 96x96	[*] M29914.	Frontal adapter 72x72 > 96x96
Adap.Frontal 48x48 -> 72x72	[4] M29911.	Frontal adapter 48x48 > 72x72
Adap.Frontal 48x48 -> 96x96	[4] M29912.	Frontal adapter 48x48 > 96x96
Adap.Frontal 48x96 -> 96x96	[*] M29913.	Frontal adapter 48x48 > 96x96

DHC-96

M	2	2	X	X	X	0	0	X	
Code	Internal Code		↑	Delivery time	+ €				
Auxiliary supply	Standard (80... 270 V _{ca} /V _{cc})	0	-	-	-				
	18 ... 36 V _{cc}	3	1	49,42					

DHC-96-CPM / DHC-96 Vdc

M	2	2	X	X	X	0	0	X	
Code	Internal Code		↑	Delivery time	+ €				
Auxiliary supply	Standard (100... 270 V _{ca} /V _{cc})	0	-	-	-				
	20 ... 60 V _{cc}	4	1	71,86					

Table: Measurement transducer selection

	Voltage (V ac)	CVE / CV-A	Active power (kW)	CW
	Voltage (V ac)	CV-D	Reactive power (kvar)	CY
	Current (A ac)	CCE / CC-A / TP-420 / TC-020 / TCB / TCM	Frequency (Hz)	CFE / CF
	Current (A dc)	CC-D	Temperature	CT-PT100

**CVE/CCE/CFE** Narrow section transducers

Narrow-profile transducers, 230 Vac, 45 ... 65Hz.

Type	Code	System	Parameters	Measure	Output type	Analog output
AC Voltage transducer						
CVE-A	[*] M25011.	-	V ~	300 Vac	2	4...20mA
CVE-A-AP	[3] M25021.	-	V ~	230 Vac	1	0...20mA
AC Current transducer						
CCE-A	[*] M25111.	-	A ~	5 A	2	4...20mA
CCE-A-AP	[*] M25121.	-	A ~	5 A	1, 3	0...20mA
Frequency transducers						
CFE	[3] M25511.	Network voltage: 50 ... 600 Vac	-	45 55 Hz	2	4...20mA
CFE-AP	[3] M25521.	Selecting Network voltage: 115 / 240 / 400 Vac	-	45 55 Hz	1	0...20mA

Specify ACCORDING TO THE CODE TABLE: 1. Code/ 2. Input range / 3. Output range / 4. Auxiliary power supply / 5. Specify the network voltage for CFE-AP. xxx-AP types external auxiliary supply not required. 4...20 mA output not possible.

For other values, see coding table on following pages

Converters

**CV** Voltage transducer

Type	Code	Parameters	Measure	Output type	Analog output
AC Voltage. Accuracy: ± 0,2 % reading, 40...90 Hz					
CV-A-AP Out1	[1] M25041.	V ~	300 Vac	1	0...20mA
CV-A Out1	[1] M25031.	V ~	300 Vac	1	0...20mA
CV-A Out2	[1] M25032.	V ~	300 Vac	2	4...20mA
CV-A-RMS Out1	[1] M25051.	V ~	300 Vac	1	0...20mA
CV-A-RMS Out2	[1] M25052.	V ~	300 Vac	2	4...20mA

DC Voltage. Auxiliary supply 230 V, 40...90 Hz, Accuracy: ± 0,5 % reading

CV-D Out1,3	[1] M25061.	Vdc	10 Vdc	1, 3	0...20mA
CV-D Out2	[1] M25062.	Vdc	10 Vdc	2	4...20mA

-AP type: Accuracy: ± 0,5 % reading, 40...90 Hz. External auxiliary supply not required. Specify: Zero value, full scale and output type.

For other values, see coding table on following pages

**CC** Current transducer

Type	Code	Parameters	Measure	Output type	Analog output
AC Current. Accuracy: ± 0,2 % reading, 40...90 Hz					
CC-A Out1	[1] M25131.	A ~	5 Aac	1	0...20mA
CC-A Out2	[*] M25132.	A ~	5 Aac	2	4...20mA
CC-A-AP	[*] M25141.	A ~	5 Aac	1	0...20mA
CC-A-RMS Out1	[1] M25151.	A ~	5 Aac	1	0...20mA
CC-A-RMS Out2	[*] M25152.	A ~	5 Aac	2	4...20mA

C.C.Current. Auxiliary supply 230 V, 40...90 Hz, Accuracy: ± 0,5 % reading.

CC-D Out1	[1] M25161.	A dc	20 mA	1, 3	0...20mA
CC-D Out2	[1] M25162.	A dc	20 mA	2	4...20mA

-AP type: Accuracy: ± 0,5 % reading, 40...90 Hz. External auxiliary supply not required. Specify: Zero value, full scale and output type.

For other values, see coding table on following pages



CW, Active power transducer

Type	Code	System	Parameters	Output type	Analog output
Active power. Auxiliary supply 230 V, 40...90 Hz, Accuracy: ± 0,5 % reading					
CW-M Out2	[1] M25212.	Single-phase	kW	2	4...20mA
CW-TE Out1,3	[1] M25221.	Balanced three-phase	kW	1, 3	0...20mA
CW-TE Out2	[1] M25222.	Balanced three-phase	kW	2	4...20mA
CW-TA Out1,3	[1] M25231.	Unbalanced three-phase ARON (3 wires)	kW	1, 3	0...20mA
CW-TA Out2	[1] M25232.	Unbalanced three-phase ARON (3 wires)	kW	2	4...20mA
CW-TAN Out1,3	[1] M25241.	Unbalanced three-phase (4 wires)	kW	1, 3	0...20mA

Indicate: Zero value, fullscale, type of output, Un (between phases), In and Fn.

For other values, see coding table on following pages



CY, Reactive power transducer

Type	Code	System	Parameters	Output type	Analog output
Reactive power. Auxiliary supply 230 V, 40...90 Hz, Accuracy: ± 0,5 % reading					
CY-M Out1,3	[1] M25251.	Single-phase	kvar	1, 3	0...20mA
CY-M Out2	[1] M25252.	Single-phase	kvar	2	4...20mA
CY-TE Sal.1,3	[1] M25261.	Balanced three-phase	kvar	1, 3	0...20mA
CY-TE Sal.2	[1] M25262.	Balanced three-phase	kvar	2	4...20mA
CY-TA Out1,3	[1] M25271.	Unbalanced three-phase ARON (3 wires)	kvar	1, 3	0...20mA
CY-TA Out2	[1] M25272.	Unbalanced three-phase ARON (3 wires)	kvar	2	4...20mA
CY-TAN Sal1,3	[1] M25281.	Unbalanced three-phase (4 wires)	kvar	1, 3	0...20mA
CY-TAN Out2	[1] M25282.	Unbalanced three-phase (4 wires)	kvar	2	4...20mA

Indicate: Zero value, fullscale, type of output, Un (between phases), In and Fn.

For other values, see coding table on following pages



CF, Frequency transducers

Type	Code	Measure	Output type	Analog output
Auxiliary supply 230 V, 40...90 Hz, Accuracy: ± 0,2 % reading				
CF Out1	[3] M25531.	45 ... 55 Hz (60 ... 660 Vac)	1	0...20mA
CF Out2	[1] M25532.	45 ... 55 Hz (60 ... 660 Vac)	2	4...20mA

Indicate: Zero value, fullscale and type of output.

For other values, see coding table on following pages



CT-PT, Temperature transducer

Type	Code	Measure	Output type	Analog output
Temperature				
CT-PT100 Out1,3	[1] M25651.	According probe PT-100	1, 3	0...20mA
CT-PT100 Out2	[*] M25652.	According probe PT-100	2	4...20mA

Indicate: Zero value, fullscale and type of output.

For other values, see coding table on following pages

TABLE OF ADDITIONAL FEATURES

Narrow section transducers

		M	2	X	X	X	X	0	0	X	X	X	X	X	Delivery time
Code		Internal code													
Voltage CVE-A	Standard (300 V)	0													-
	110 V	1													2
	400 V	2													2
	500 V	3													2
	690 V	4													2
Voltage CVE-A-AP	Standard (230 V)	0													-
	110 V	1													2
	400 V	2													2
Current CCE	Standard (5 A)	0													-
	1 A	1													2
	10 A	4													2
Frequency CFE	Standard (45...55 Hz)	0													-
	55...65 Hz	1													2
	47...53 Hz	2													2
	45...65 Hz	3													2
	0...100 Hz	4													2
	380...420 Hz	5													2
	360...440 Hz	6													2
	340...460 Hz	7													2
Output 2	Standard (4...20 mA)	0													-
	0...20 mA	1													2
CVE-A, CCE-A, CFE	0...10 V	2													2
	2...10 V	3													2
Output 1,3 CVE-A-AP, CCE-A-AP, CFE-AP	Standard (0...20 mA)	0													-
	0...10 V	1													2
Auxiliary supply	Standard (220...240 V)	0													-
	380...400 Vca 40/60 Hz	3													2
Network voltage	Standard (230 V)									0	0				2
	110 V									0	1				2
CFE-AP	400 V									0	2				2

For other values consult



Transducers

		M	2	X	X	X	X	0	0	X	X	X	Delivery time
Code		Internal code											
AC Voltage CV-A	Standard (300 V)	0											-
	110 V	1											1
	400 V	2											1
	500 V	3											1
	690 V	4											1
AC Current CC-A	Standard (5 A)	0											-
	1 A	1											1
	10 A	4											1
DC Voltage CV-D	Standard (10 V)	0											-
	60 mV	1											1
	1 V	2											1
	100 V	3											1
	500 V	4											1
DC Current CC-D	Standard (20 mA)	0											-
	200 mA	1											1
	1 A	2											1
	10 A	3											1
	300 V, .../5 A	N											1
Power CW, CY	110 V, .../5 A	1											1
	400 V, .../5 A	2											1
	500 V, .../5 A	3											1
	600 V, .../5 A	4											1
	300 V, .../1 A	5											1
	110 V, .../1 A	6											1
	400 V, .../1 A	7											1
	500 V, .../1 A	8											1
	600 V, .../1 A	9											1
Temperature CT-PT	Standard (-200...+200 °C)	0											-
	-200...+800 °C	1											1
Frequency CF	Standard (45...55 Hz)	0											-
	55...65 Hz	1											1
	47...53 Hz	2											1
	57...63 Hz	3											1
	0...100 Hz	4											1
Outputs 1,3	Standard (20 mA)	0											-
	0...1 mA	1											1
	0...10 mA	2											1
	2 V	3											1
	5 V	4											1
	0...10 V	5											1
	-20...0...20 mA	6											1
	-10...0...10 V	7											1
-5...0...5 V	8											1	
Outputs 2	Standard (4...20 mA)	0											-
	2...10 V	2											1
Auxiliary supply	Standard (220...240 V)	0											-
	100...120 Vac	1											2
	380...400 Vca 40/60 Hz	3											2
	18...36 Vdc	7											2
	40...170 Vdc	9										2	

For others values, consult





TI

Current transformer with converter 4 ... 20 mA

Type	TI-420			TP-420		TCM-420	TCB-420	
	TI-420-35	TI-420-70	TI-420-105	TP-420-23	TP-420-58	TCM-420-25	TCB-420-35	TCB-420-70
								
ø (mm)	35	70	105	-	-	25	35	70
Plat (mm)	-	-	-	20 x 30	50 x 80	-	-	-
Taille (mm) larg.x haut. xprof.	100x79x33	130x110x33	170x146x33	110x89x58	145x114x50	70x87x70	166x79x33	196x110x33
	10... 28 VCC alimentation sortie 4... 20 mA					Alimentation interne sortie 4... 20 mA (230 VCA alimentation auxiliaire)		
A	Code	Code	Code	Code	Code	Code	Code	Code
2.5	[1] M70811.					[2] M71041.	[3] M71011.	
5	[*] M70812.			[*] M70211.		[*] M71042.	[*] M71012.	
10	[*] M70813.			[*] M70212.		[*] M71043.	[*] M71013.	
20	[*] M70814.			[*] M70213.		[*] M71044.	[*] M71014.	
50	[*] M70815.			[*] M70214.		[*] M71045.	[*] M71015.	
100	[*] M70816.	[*] M70821.		[*] M70215.	[*] M70221.	[*] M71046.	[*] M71016.	[1] M71021.
200				[*] M70216.		[*] M71047.		
250	[*] M70817.	[*] M70822.	[1] M70831.	[*] M70217.	[*] M70222.		[*] M71017.	[*] M71022.
500		[*] M70823.	[1] M70832.	[*] M70218.	[*] M70223.			[*] M71023.
750		[*] M70824.	[1] M70833.		[*] M70224.			[*] M71024.
1000			[1] M70834.					
Pour des courants supérieurs, utiliser transformateur + convertisseur								
EUR								

TC-420

Current transformers with converter 4 ... 20 mA or 0 ... 20 mA

Type	TC5-420	TC6-420	TC8-420	TC6-020	TC8-020
					
ø (mm)	20	28	44	28	44
Plat (mm)	25 x 5	40 x 10	60 x 12	40 x 10	60 x 12
Taille (mm) larg.x haut. xprof.	58x70x32	64x80.5x44	84.5x102x50	64x80.5x44	84.5x102x50
	Sortie 4... 20 mA, alim. extérieure 7,5... 36 Vcc			Sortie 0...20 mA	
A	Code	Code	Code	Code	Code
5	[*] M72112.				
10	[*] M72113.				
20	[*] M72114.				
50		[*] M72131.		[*] M72031.	
100		[*] M72132.		[*] M72032.	
200		[*] M72134.		[*] M72034.	
300		[*] M72136.		[*] M72036.	
500			[*] M72151.		[3] M72051.
1000			[*] M72152.		[1] M72052.
Pour des courants supérieurs, utiliser transformateur + convertisseur					
EUR					

Dimensions

DCB

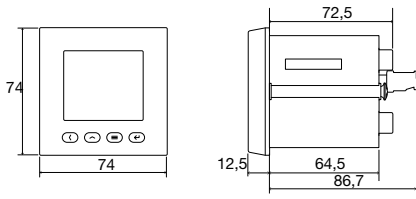

DHC-96

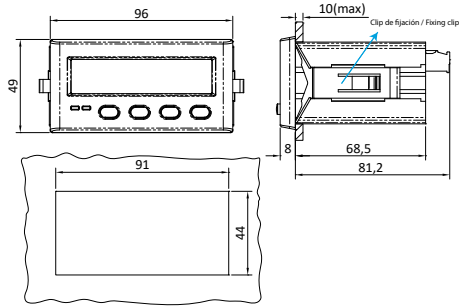

DHC-96 CPM

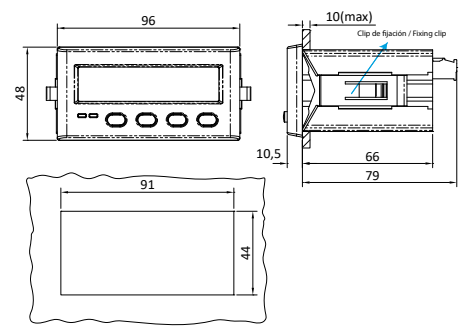

DHB

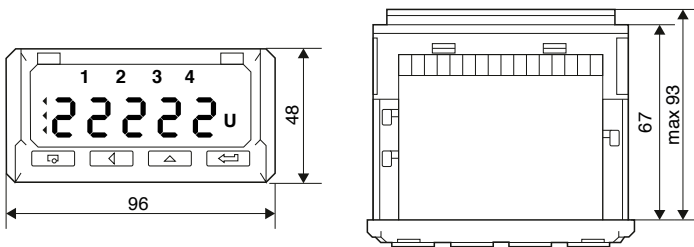

DHC-96 CPM-1500

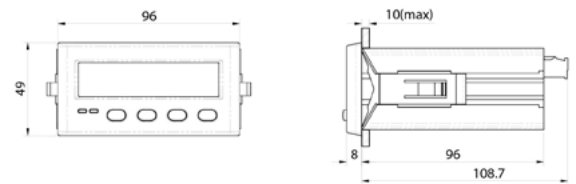

CV-A / CV-D / CC-A / CC-D / CR2 / CT-PT100 / CUP / CF

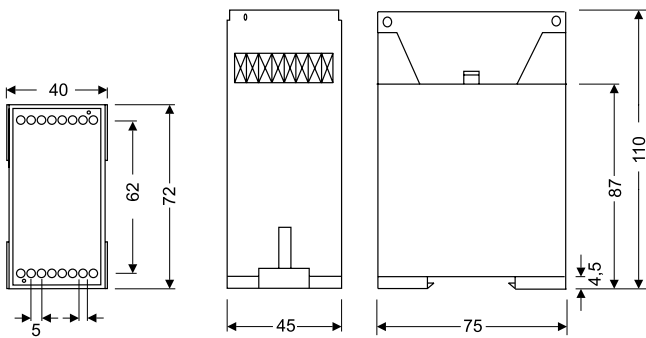

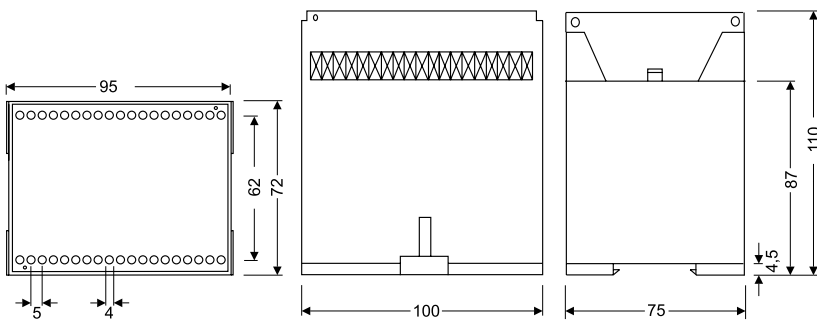

CW / CY / CPF / CCOS / CFD



Analogue instruments

Analogue instrument selection table

	Measurement system	Assembly	Specifications	Range	Size mm	Accuracy class	Scale angle	Scale extension	Type		
Voltmeters	CC 	Panel	-	5...100 A, .../5A	72 x 72, 96 x 96	1,5	240°	P1	EC		
				.../5A					EZC		
			With switch	.../5A					EC FA		
			With relays	.../5A					CEC		
	AC 	Panel	-	5...60 A, .../60 mV	48 x 48, 72 x 72, 96 x 96, 144 x 144	1,5	90°	P1	BC		
				.../60 mV	CBC						
				150 ... 600 V, .../110 V	48 x 48, 72 x 72, 96 x 96, 144 x 144				90°	EC	
				250 V, 500 V	72 x 72, 96 x 96				240°	P1	EZC
Process indicators	CC 	Panel	-	0...600 V	48 x 48, 72 x 72, 96 x 96, 144 x 144	1,5	90°	P1	BC		
				.../60 mV	96 x 96				P1	CBC	
				150 ... 600 V	72 x 72, 96 x 96				240°	P1	EC F
			With relays	150 ... 600 V, .../110 V	96 x 96				CEC		
	Maximeters	-	Panel	Bimetallic	.../5 A				P1,2	MC	
				Bimetallic + HM					P2	EMC	
	Sheet	Needle	Panel	-	45...65 Hz depending type	48 x 48, 72 x 72, 96 x 96, 144 x 144	0,5	90°	-	HC	
				Sheets		-				72 x 72, 96 x 96, 144 x 144	HLC
Wattmeter	Panel	Single-phase	400 V, .../5 A	96 x 96, 144 x 144	1,5	90°	P1	WMC			
		Three-phase						WTC			
Phase-meters Electronic	Panel	Single-phase	cos φ 0,5 - 1 - 0,5	96 x 96, 144 x 144	1,5	90°	P1	FEMC			
		Three-phase						FETC			

EC / EM / EZC / CEC

Moving Iron Ammeter



Ammeters, 90° - P2 - Class 1,5

Type						
		EC 48	EC 72	EC 96	EC 144	
a		48	72	96	144	
b		48	72	96	144	
c		86,2	69,2	69,2	91,8	
A						
5		[*] M10212.	[*] M10222.	[*] M10232.	35,16 [3] M10242.	60,06
10		[*] M10213.	[*] M10223.	[*] M10233.	35,59 [3] M10243.	60,06
15		[*] M10214.	[*] M10224.	[*] M10234.	35,59 [3] M10244.	60,06
20		[*] M10215.	[*] M10225.	[*] M10235.	39,35 [3] M10245.	60,06
25		[*] M10216.	[*] M10226.	[*] M10236.	39,35 [3] M10246.	60,06
30		[*] M10217.	[*] M10227.	[1] M10237.	39,35 [3] M10247.	60,06
40		[*] M10218.	[*] M10228.	[*] M10238.	39,35 [3] M10248.	60,06
50		[*] M10219.	[*] M10229.	[*] M10239.	39,35 [3] M10249.	60,06
60		[*] M1021A.	[*] M1022A.	[*] M1023A.	39,35 [3] M1024A.	60,06
75		-	[*] M1022B.	[1] M1023B.	41,93 [3] M1024B.	60,06
100		-	[*] M1022C.	[*] M1023C.	41,93 [3] M1024C.	60,06
.../5 A (*)		[*] M10210.	[*] M10220.	[*] M10230.	32,17 [3] M10240.	57,54

(*) Exchangeable scales. See next page.

	Ammeters with phase switch		Ammeters with 2 relays
Type	EC 72 FA	EC 96 FA	CEC 96
Class	1,5		1,5
Scale	90°, P1		90°, P2
a		72	96
b		72	96
c		69,2	69,2
/A	(*) .../5 A(*)	(*) .../5 A(*)	(*) .../5 A
(*) .../5 A(*)	[*] M10521.	[*] M10531.	[*] M14810.
EUR	88,25	88,25	248,11

(*) Exchangeable scales. See next page.

(*) Specify primary current of the measuring transformer

Exchangeable scales, moving iron ammeters

Type	SEC 48	SEC 72	SEC 96	SEC 72 FA	SEC 96 FA	
Equipment	EC 48	EC 72	EC 96	EC 72 FA	EC 96 FA	
A						EUR
5/5	[*] M102Z2.	[*] M102Y2.	[*] M102X2.	-	-	2,53
10/5	[*] M102Z3.	[*] M102Y3.	[*] M102X3.	-	-	2,53
15/5	[*] M102Z4.	[*] M102Y4.	[*] M102X4.	-	-	2,53
20/5	[*] M102Z5.	[*] M102Y5.	[*] M102X5.	-	-	2,53
25/5	[*] M102Z6.	[*] M102Y6.	[*] M102X6.	-	-	2,53
30/5	[*] M102Z7.	[*] M102Y7.	[*] M102X7.	-	-	2,53
40/5	[*] M102Z8.	[*] M102Y8.	[*] M102X8.	-	-	2,53
50/5	[*] M102Z9.	[*] M102Y9.	[*] M102X9.	[*] M105Y9.	[*] M105X9.	2,53
60/5	[*] M102ZA.	[*] M102YA.	[*] M102XA.	[2] M105YA.	[*] M105XA.	2,53
75/5	[*] M102ZB.	[*] M102YB.	[*] M102XB.	[*] M105YB.	[*] M105XB.	2,53
100/5	[*] M102ZC.	[*] M102YC.	[*] M102XC.	[*] M105YC.	[*] M105XC.	2,53
125/5	[*] M102ZD.	[*] M102YD.	[*] M102XD.	[2] M105YD.	[*] M105XD.	2,53
150/5	[*] M102ZE.	[*] M102YE.	[*] M102XE.	[*] M105YE.	[2] M105XE.	2,53
200/5	[*] M102ZF.	[*] M102YF.	[*] M102XF.	[*] M105YF.	[*] M105XF.	2,53
250/5	[*] M102ZG.	[*] M102YG.	[*] M102XG.	[*] M105YG.	[*] M105XG.	2,53
300/5	[*] M102ZH.	[*] M102YH.	[*] M102XH.	[*] M105YH.	[*] M105XH.	2,53
400/5	[*] M102ZJ.	[*] M102YJ.	[*] M102XJ.	[*] M105YJ.	[*] M105XJ.	2,53
500/5	[2] M102ZK.	[*] M102YK.	[*] M102XK.	[*] M105YK.	[*] M105XK.	2,53
600/5	[*] M102ZL.	[*] M102YL.	[*] M102XL.	[*] M105YL.	[*] M105XL.	2,53
750/5	[*] M102ZM.	[*] M102YM.	[*] M102XM.	[*] M105YM.	[*] M105XM.	2,53
800/5	[*] M102ZN.	[*] M102YN.	[*] M102XN.	[*] M105YN.	[*] M105XN.	2,53
1 000/5	[*] M102ZP.	[*] M102YP.	[*] M102XP.	[*] M105YP.	[*] M105XP.	2,53
1 200/5	[*] M102ZQ.	[*] M102YQ.	[*] M102XQ.	[*] M105YQ.	[*] M105XQ.	2,53
1 500/5	[*] M102ZR.	[*] M102YR.	[*] M102XR.	[*] M105YR.	[*] M105XR.	2,53
2 000/5	[*] M102ZS.	[*] M102YS.	[*] M102XS.	[*] M105YS.	[*] M105XS.	2,53
2 500/5	[*] M102ZT.	[*] M102YT.	[*] M102XT.	[*] M105YT.	[*] M105XT.	2,53
3 000/5	[*] M102ZU.	[*] M102YU.	[*] M102XU.	[*] M105YU.	[*] M105XU.	2,53
4 000/5	[*] M102ZV.	[*] M102YV.	[*] M102XV.	[*] M105YV.	[*] M105XV.	2,53
5 000/5	[*] M102ZW.	[2] M102YW.	[*] M102XW.	[*] M105YW.	[*] M105XW.	2,53

EC / CEC
Moving Iron Voltmeters



Voltmeters, 90°

Type	EC 48	EC 72	EC 96	EC 144		
Class	1,5					
Scale	90°, P1					
a	48	72	96	144		
b	48	72	96	144		
c	86,2	69,2	69,2	91,8		
V			EUR		EUR	
250	[*] M10415.	[*] M10425.	[*] M10435.	40,21	[3] M10445.	60,06
300	[*] M10416.	[*] M10426.	[*] M10436.	40,21	[3] M10446.	60,06
400	[*] M10417.	[*] M10427.	[*] M10437.	40,21	[3] M10447.	60,06
500	[*] M10418.	[*] M10428.	[*] M10438.	38,06	[3] M10448.	60,06
600	[1] M10419.	[*] M10429.	[*] M10439.	42,76	[3] M10449.	60,06
.../110 V(*)	[1] M10410.	[*] M10420.	[*] M10430.	39,64	[3] M10440.	57,54

(*) Exchangeable scales, Voltmeters 90°

Voltmeters with phases switch

Voltmeters with 2 relays

		Three-phase 3 wire		Three-phase 4 wire		with sequence meter		
Type	EC 72 F III	EC 96 F III	EC 72 F III +N	EC 96 F III +N	EC 96 FN-S	CEC 96		
Class	1,5						1,5	
Scale	90°, P1						90°, P1	
a	72	96	72	96	96	96		
b	72	96	72	96	96	96		
c	69,2	69,2	69,2	69,2	69,2	110		
V			EUR		EUR		EUR	
150	-	-	-	-	-	- [3] M14821. 248,11		
250	[*] M10625.	[3] M10635.	81,23	[*] M10725.	[3] M10735.	85,38	- [3] M14822. 248,11	
300	[*] M10626.	[*] M10636.	81,23	[*] M10726.	[*] M10736.	85,38	- [3] M14823. 248,11	
400	[*] M10627.	[3] M10637.	81,23	[*] M10727.	[3] M10737.	85,38	- [3] M14824. 248,11	
500	[*] M10628.	[*] M10638.	80,04	[*] M10728.	[*] M10738.	85,38	[2] M11038. 129,62 [3] M14825. 248,11	
600	[*] M10629.	[3] M10639.	80,04	[*] M10729.	[3] M10739.	85,38	- [3] M14826. 248,11	
(1).../110 V	-	[2] M10632.	104,47	-	-	-	- [3] M14820. 248,11	

(1) Specify primary voltage of the measuring transformers

Exchangeable scales, moving iron voltmeters, 1,2P

Type	SEC 48	SEC 72	SEC 96	
Equipment	EC 48	EC 72	EC 96	
V				EUR
1 000/110	[1] M104Z1.	[1] M104Y1.	[1] M104X1.	2,53
3 300/110	[1] M104Z2.	[1] M104Y2.	[1] M104X2.	2,53
6 600/110	[1] M104Z3.	[1] M104Y3.	[1] M104X3.	2,53
13 200/110	[1] M104Z4.	[1] M104Y4.	[1] M104X4.	2,53
15 000/110	[1] M104Z5.	[1] M104Y5.	[1] M104X5.	2,53
20 000/110	[1] M104Z6.	[1] M104Y6.	[1] M104X6.	2,53
22 000/110	[1] M104Z7.	[1] M104Y7.	[1] M104X7.	2,53
25 000/110	[1] M104Z8.	[1] M104Y8.	[1] M104X8.	2,53

TABLE OF ADDITIONAL FEATURES

EC Voltmeters with external transformer

Code		Internal code				
M 1 X X X X 0 0 X X X						
Adjustment	Standard 1,2P	0			Delivery time	+ €
	1P	1				
Voltage input	Standard (.../110 V)	0				
	.../ 100 V	1				
	.../ 63,5 V	2				
	.../ 57,8 V	3				
Scales (For equipments with external transformer and all EC)	1000		1	2	2,53	
	3300		2	2	2,53	
	6600		3	2	2,53	
	13200		4	2	2,53	
	15000		5	2	2,53	
	20000		6	2	2,53	
	22000		7	2	2,53	
	25000		8	2	2,53	

(*) Price 0 € for EC 144 and EZC

EC and EC-F direct Voltmeters

Code		Internal code				
M 1 X X X X 0 0 X						
Adjustment	Standard 1P	0			Delivery time	+ €
	1,2P	2				

EC scales



Code		Internal code				
M 1 X X X X 0 0 X X						
Adjustment	Standard 1,2P	0			Delivery time	+ €
	1P	1				
Voltage inputs	Standard (.../110 V)	0				
	.../ 100 V	1				
	.../ 63,5 V	2				
	.../ 57,8 V	3				

(*) Price for equipment. Price 0 € for scales

BC / CBC

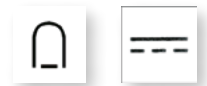
Moving coil ammeters



Ammeters, 90°				ammeters with 2 relays		
						
Type	BC 48	BC 72	BC 96	BC 144	CBC 96	
Class	1,5				1,5	
Scale	90°, P1				90°, P1	
a	48	72	96	144	96	
b	48	72	96	144	96	
c	86,2	69,2	69,2	91,8	110	
A	EUR			EUR	EUR	
5	[3] M11412.	[*] M11422.	[3] M11432.	68,26	[3] M11442.	101,33
10	[3] M11413.	[*] M11423.	[3] M11433.	68,26	[3] M11443.	101,33
25	[*] M11416.	[*] M11426.	[*] M11436.	68,26	[3] M11446.	101,33
50	[3] M11419.	[*] M11429.	[3] M11439.	70,04	[3] M11449.	103,93
60	-	[3] M1142A.	[3] M1143A.	74,65	[3] M1144A.	103,93
.../60 mV(*)	[*] M11410.	[*] M11420.	[*] M11430.	64,45	[3] M11440.	91,51
					[3] M14830.	262,42

(*) Exchangeable scales. See M.7 for external shunts

Exchangeable Scales

Type	SBC 48	SBC 72	SBC 96	Type	SBC 48	SBC 72	SBC 96		
Device	BC 48	BC 72	BC 96	Device	BC 48	BC 72	BC 96		
A / mV	EUR			A / mV	EUR				
50/60	[1] M114Z9.	[1] M114Y9.	[*] M114X9.	2,53	300/60	[1] M114ZH.	[1] M114YH.	[1] M114XH.	2,53
60/60	[1] M114ZA.	[1] M114YA.	[1] M114XA.	2,53	400/60	[1] M114ZJ.	[1] M114YJ.	[*] M114XJ.	2,53
75/60	[1] M114ZB.	[1] M114YB.	[1] M114XB.	2,53	600/60	[1] M114ZL.	[*] M114YL.	[*] M114XL.	2,53
100/60	[1] M114ZC.	[*] M114YC.	[*] M114XC.	2,53	1 000/60	[1] M114ZP.	[1] M114YP.	[*] M114XP.	2,53
150/60	[1] M114ZE.	[1] M114YE.	[1] M114XE.	2,53	1 500/60	[1] M114ZR.	[1] M114YR.	[1] M114XR.	2,53
200/60	[1] M114ZF.	[*] M114YF.	[*] M114XF.	2,53	2 500/60	[1] M114ZT.	[1] M114YT.	[1] M114XT.	2,53
250/60	[1] M114ZG.	[1] M114YG.	[1] M114XG.	2,53					

TABLE OF ADDITIONAL FEATURES

BC ammeter

Code	Internal code			Delivery time	+ €
M 1 X X X X 0 0	X	X	X		
Adjustment	Standard	0		-	-
	central zero	1		2	9,23
	Standard (.../60 mV)	0		-	-
Shunt input range	.../50 mV	1		2	6,26
	.../150 mV	3		2	6,26
	.../300 mV	5		2	6,26
Scale	50	9		2	2,53
	60	A		2	2,53
	75	B		2	2,53
	100	C		2	2,53
	150	E		2	2,53
	200	F		2	2,53
	250	G		2	2,53
	300	H		2	2,53
	400	J		2	2,53
	500	K		2	2,53
	600	L		2	2,53
	1000	P		2	2,53
	1500	R		2	2,53
	2500	T		2	2,53

(*) Price 0 € for BC 144 and ZC

SBC scales

Code	Internal code			Delivery time	+ €
M 1 X X X X 0 0	X	X	X		
Adjustment	Standard	0		-	-
	central zero	1		2	-
	Standard (.../60 mV)	0		-	-
Shunt input range	.../50 mV	1		2	-
	.../150 mV	3		2	-
	.../300 mV	5		2	-

BC / ZC

Process indicators

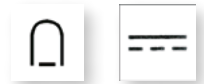

Process indicators, 90°

Type	BC 48	BC 72	BC 96	BC 144		
Class	1,5					
Scale	90°, P1					
a	48	72	96	144		
b	48	72	96	144		
c	86,2	69,2	69,2	91,8		
Scope				EUR	EUR	
0...10 V	[*] M11813.	[*] M11823.	[*] M11833.	68,26	[3] M11843.	109,88
0...20 mA	[1] M11812.	[1] M11822.	[1] M11832.	68,26	[3] M11842.	113,16
4...20 mA	[*] M11811.	[*] M11821.	[*] M11831.	87,49	[3] M11841.	130,98

Scales NOT included

Exchangeable scales

Type	SIP 48	SIP 72	SIP 96	
Equipment	BC 48	BC 72	BC 96	
Scope				EUR
0...10 V	[3] M118Z3.	[3] M118Y3.	[3] M118X3.	9,82
0...20 mA	[3] M118Z2.	[3] M118Y2.	[3] M118X2.	9,82
4...20 mA	[3] M118Z1.	[3] M118Y1.	[3] M118X1.	9,82

Process indicators, 240°

Type						
	ZC 72		ZC 96		ZC 144	
Class	1,5					
Scale	240°, P1					
a	72		96		144	
b	72		96		144	
c	69,2		69,2		91,8	
Scope				EUR	EUR	
0...10 V	[1] M12523.		[1] M12533.		183,91	[1] M12543. 259,09
4...20 mA(*)	[1] M12521.		[1] M12531.		208,61	[1] M12541. 291,70
.../60 mV	[1] M12520.		[1] M12530.		181,38	[1] M12540. 255,07

(*) Scale included in the price
The 6-digit code already includes the 4...20 mA scale

MC /EMC
Maximeter ammeters

Bimetallic maximeter ammeter					Bimetallic maximeter ammeters + moving iron ammeters		
Type	MC 48	MC 72	MC 96	MC 144	EMC 72	EMC 96	EMC 144
Class	3				Bimetallic: 3 Moving iron:1,5		
Scale	90°, P1,2				Double Scale 90°, P1,2, moving iron P2		
a	48	72	96	144	72	96	144
b	48	72	96	144	72	96	144
c	86,2	69,2	69,2	91,8	69,2	69,2	91,8
A							
.../ 5 A	[1] M12211.	[*] M12221.	[*] M12231.	[3] M12241.	[*] M12622.	[*] M12632.	[3] M12642.
EUR	49,42	49,42	49,42	74,73	88,50	88,50	151,60
Scales NOT included. Adjustment 15 minutes							
Scale	120% 90°, P1,2						
.../ 5 A		[3] M15521.	[3] M15531.				
EUR		61,38	61,38				

Scale included. Adjustment 15 minutes

Exchangeable scales

Type	SMC 48	SMC 72	SMC 96	SEMC 72	SEMC 96	
Equipment	MC 48	MC 72	MC 96	EMC 72	EMC 96	
A						EUR
100/5	[1] M122ZC.	[*] M122YC.	[*] M122XC.	[*] M126YC.	[*] M126XC.	2,53
200/5	[*] M122ZF.	[*] M122YF.	[*] M122XF.	[*] M126YF.	[*] M126XF.	2,53
300/5	[*] M122ZH.	[*] M122YH.	[*] M122XH.	[*] M126YH.	[*] M126XH.	2,53
400/5	[*] M122ZJ.	[*] M122YJ.	[*] M122XJ.	[*] M126YJ.	[*] M126XJ.	2,53
500/5	[*] M122ZK.	[*] M122YK.	[*] M122XK.	[*] M126YK.	[*] M126XK.	2,53
600/5	[1] M122ZL.	[3] M122YL.	[*] M122XL.	[3] M126YL.	[*] M126XL.	2,53
750/5	[1] M122ZM.	[3] M122YM.	[*] M122XM.	[*] M126YM.	[*] M126XM.	2,53
800/5	[1] M122ZN.	[*] M122YN.	[*] M122XN.	[*] M126YN.	[*] M126XN.	2,53
1 000/5	[1] M122ZP.	[*] M122YP.	[*] M122XP.	[*] M126YP.	[*] M126XP.	2,53
1 500/5	[1] M122ZR.	[*] M122YR.	[*] M122XR.	[*] M126YR.	[*] M126XR.	2,53
2 000/5	[1] M122ZS.	[*] M122YS.	[*] M122XS.	[*] M126YS.	[*] M126XS.	2,53

TABLE OF ADDITIONAL FEATURES

MC and EMC maximeters and SMC and SEMC scales

Code	Internal code	Delivery time	+ €
M 1 X X X X 0 0 X X X			
Current input	Standard (.../5 A)	0	-
	.../1 A	1	-
	100	C	2 2,53
	125	D	2 2,53
	150	E	2 2,53
	200	F	2 2,53
	250	G	2 2,53
	300	H	2 2,53
	400	J	2 2,53
	500	K	2 2,53
	600	L	2 2,53
Scale	750	M	2 2,53
	800	N	2 2,53
	1000	P	2 2,53
	1200	Q	2 2,53
	1500	R	2 2,53
	2000	S	2 2,53
	2500	T	2 2,53
	3000	U	2 2,53
	4000	V	2 2,53
	5000	W	2 2,53

WMC / WTC Wattmeters



WATTMETERS, 45 ... 65 Hz

Type	Single-phase		Balanced three-phase		Three-phase 3 wire (ARON)		Three-phase 4 wire	
	WMC 96	WMC 144	WTC 96E	WTC 144E	WTC 96A	WTC 144A	WTC 96AN	WTC 144AN
Class	1,5							
Scale	90° P1							
	a	96	144	96	144	96	144	144
	b	96	144	96	144	96	96	144
	c	69,2	91,8	69,2	91,8	82,9	91,8	82,9
U _{phase-phase}	400 V		400 V		110 V (*)		400 V	
	[*] M13031.	[4] M13041.	[*] M13032.	[4] M13042.	[3] M13034.	[4] M13044.	[*] M13033.	[4] M13043.
EUR	229,31	250,12	230,37	252,88	320,01	359,20	330,66	363,84

Exchangeable scales for the WMC 96, WTC 96E and WTC 96AN equipment. Scales NOT included
(*) Specify primary voltage and current of the measuring transformers, and power at full scale

Wattmeters Exchangeable scales

Type	Single-phase		Three-phase		EUR	
	SWM 96		SWT 96E (*) SWT 96AN (*)			
Equipment	WMC 96		WTC 96E WTC 96AN			
A	Full scale	Code	Full scale	Code	Code	EUR
50/5	20 kW	[1] M130J9.	30 kW	[1] M130K9.	[1] M130L9.	2,53
75/5	-	-	50 kW	[1] M130KB.	[1] M130LB.	2,53
100/5	40 kW	[1] M130JC.	60 kW	[1] M130KC.	[1] M130LC.	2,53
150/5	60 kW	[1] M130JE.	90 kW	[1] M130KE.	[1] M130LE.	2,53
200/5	80 kW	[1] M130JF.	120 kW	[1] M130KF.	[1] M130LF.	2,53
300/5	120 kW	[1] M130JH.	180 kW	[1] M130KH.	[1] M130LH.	2,53
400/5	160 kW	[1] M130JJ.	240 kW	[1] M130KJ.	[1] M130LJ.	2,53
500/5	200 kW	[1] M130JK.	300 kW	[1] M130KK.	[1] M130LK.	2,53
600/5	240 kW	[1] M130JL.	360 kW	[1] M130KL.	[1] M130LL.	2,53
1 000/5	400 kW	[1] M130JP.	600 kW	[1] M130KP.	[1] M130LP.	2,53
1 500/5	600 kW	[1] M130JR.	900 kW	[1] M130KR.	[1] M130LR.	2,53
2 000/5	800 kW	[1] M130JS.	1,2 MW	[1] M130KS.	[1] M130LS.	2,53
3 000/5	1,2 MW	[1] M130JU.	1,8 MW	[1] M130KU.	[1] M130LU.	2,53
4 000/5	1,6 MW	[1] M130JV.	2,4 MW	[1] M130KV.	[1] M130LV.	2,53
5 000/5	2,0 MW	[1] M130JW.	3 MW	[1] M130KW.	[1] M130LW.	2,53

(*) Balanced three-phase wattmeters type WTC 96E 230 V, 400 V

(*) Unbalanced three-phase wattmeters type WTC 96AN 400 V

TABLE OF ADDITIONAL FEATURES

Wattmeters scales

Code	Internal code	Delivery time	+ €
M 1 X X X X 0 0 X X			
Current input	Standard ... / 5 A	0	-
	... / 1 A	1	2
Voltages (V)	Standard (400 V)	0	-
	110 (a)	1	2
	230	2	2
	440	5	2
	460	6	2

(a) In ARON unbalanced three-phase Wattmeters (3 wires), the standard voltage is 110 V

Wattmeters

Code	Internal code	Delivery time	+ €
M 1 X X X X 0 0 X X X			
Current input	Standard ... / 5 A	0	-
	... / 1 A	1	2
Voltage	Standard (400 V _{ph-ph})	0	-
	110 V _{ph-ph} (a)	1	2
	230 V _{ph-ph}	2	2
	440 V _{ph-ph}	5	2
	460 V _{ph-ph}	6	2
Scale ranges	50	9	2
	75	B	2
	100	C	2
	150	E	2
	200	F	2
	300	H	2
	400	J	2
	500	K	2
	600	L	2
	1000	P	2
	1500	R	2
Primary current transformer	2000	S	2
	3000	U	2
	4000	V	2
	5000	W	2

(a) In ARON unbalanced three-phase Wattmeters (3 wires), the standard voltage is 110 V

FEMC / FETC Electronic Phasemeters 90°, 50 Hz

Type	Single-phase		Balanced three-phase	
	FEMC 96	FEMC 144	FETC 96	FETC 144
Class	1,5			
Scale	90° P1			
	96	144	96	144
	96	144	96	144
	82,9	91,8	82,9	91,8
V	cos phi 0,5-1-0,5			
100/√3	[1] M13431.	[3] M13441.	-	-
110/√3	[1] M13432.	[3] M13442.	-	-
100	[1] M13433.	[3] M13443.	[1] M1343C.	[3] M1344C.
110	[1] M13434.	[3] M13444.	[1] M1343D.	[3] M1344D.
230	[1] M13435.	[3] M13445.	[3] M1343E.	[3] M1344E.
400	[1] M13436.	[3] M13446.	[*] M1343F.	[3] M1344F.
440	[1] M13437.	[3] M13447.	[1] M1343G.	[3] M1344G.
500	[1] M13438.	[3] M13448.	[1] M1343H.	[3] M1344H.
EUR	249,85	275,83	239,52	259,09

Current range: from 0,1 to 1,2 In. To connect to .../ 5 A transformers. Electronic converter included.

PGR Protection Wattmeters

Protective dual bidirectional wattmeter, 230 V

Type	Single-phase	Balanced three-phase	Three-phase 3 wire (ARON)	Three-phase 4 wire
	PGR 96 M	PGR 96E	PGR 96A	PGR 96AN
Converter	CW-M	CW-TE	CW-TA	CW-TAN
Class	1,5			
Scale	90°, P2			
	96			
	96			
	110			
U / I				
100/√3... 500 V .../ 5 A	[4] M14721.	-	-	-
100...500 V .../5 A	-	[4] M14722.	[4] M14724.	[4] M14723.
EUR	807,73	772,54	848,46	892,88

MUST SELECT THE REST OF PARAMETERS ON THE ATTACHED TABLE

The instrument includes the analogue converter and indicator.
Specify the primary voltage and current of the current transformers, the full scale power value and main voltage. Included and exchangeable scales. Standardized scales.



TABLE OF ADDITIONAL FEATURES

Electronic phasemeters				
Code	Internal code			
M 1 X X X X 0 0 X				
		↑	Delivery time	+ €
Secondary current	Standard .../ 5 A	0	-	-
	.../1 A	1	3	9,72

PGR				
Code	Internal code			
M 1 X X X X 0 0 X X X				
		↑	↑	↑
		9	A	B
		C	D	E
		F	G	H
		J	K	L
		M	N	P
		Q	R	S
		T	U	V
		W		
Scale	50	60	75	100
	125	150	200	250
	300	400	500	600
	750	800	1000	1200
	1500	2000	2500	3000
	4000	5000		
input current	Standard (.../ 5 A)	0		
	.../1 A	1		
Power	Standard 220...240 V	0		
Supply	380 ... 400 V 40/60 Hz	3		

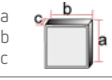

2EC / 2HC / 2HLC / SMC / STC / UC / SynchroMAX, Synchronization and marine applications equipment

2EC, Double voltmeters

			
Type	2 EC 96	2 EC 144	
Class	1,5		
Scale	90°		
 a b c	96	144	
	96	144	
	69,2	91,8	
V	EUR		EUR
2 x .../100	[3] M13831.	146,73	[4] M13841. 161,04
2 x .../110	[3] M13832.	146,73	[4] M13842. 161,04
2 x 220	[3] M13833.	146,73	[4] M13843. 161,04
2 x 380	[3] M13834.	146,73	[*] M13844. 161,04
2 x 440	[3] M13835.	154,80	[4] M13845. 166,88

Specify voltage transformers

SMC / STC, Synchrosopes, 50 Hz

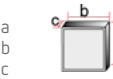

				
Type	Single-phase		Three-phase	
	SMC 96	SMC 144	STC 96	STC 144
Class	1,5		1,5	
 a b c	96	144	96	144
	96	144	96	144
	121,2	122	121,2	122
V	EUR		EUR	
110	[3] M14431.	[4] M14441.	[*] M14435.	[4] M14445.
230	[3] M14432.	[4] M14442.	[3] M14436.	[4] M14446.
400	[3] M14433.	[4] M14443.	[*] M14437.	[4] M14447.
500	[3] M14434.	[4] M14444.	[3] M14438.	[4] M14448.
	EUR 493,68	524,31	399,37	423,15

SynchroMAX, Synchronization equipment

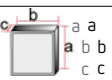
Power Supply 400 V

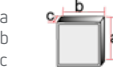

Type			
	SynchroMAX	SynchroMAX PID	
PID Control	No	Yes	
 a b c	96	96	
	96	96	
	82,9	82,9	
Frequency	30 ... 70 Hz		
V _{Measurement}	EUR		EUR
30...150	[*] M14624.	[*] M14634.	
110...600	[*] M14625.	[4] M14635.	
	EUR 457,66	981,44	

UC / CUC, Phase sequence indicators, 50 Hz

			
Type	UC 72	UC 96	CUC 96
Control Relay	No	Yes	
 a b c	72	96	96
	72	96	96
	82,9	82,9	82,9
V	EUR		EUR
100...150	[1] M13726.	[1] M13736.	-
150...500	[1] M13721.	[*] M13731.	-
230	-	-	[3] M13754.
400	-	-	[*] M13755.
	EUR 78,06	78,06	155,61

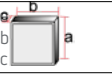

2HC, Double frequencymeters

Pointer Type, 230 V

			
Tipo	2 HC 96	2 HC 144	
Class	0,5		
Scale	90°		
 a b c	96	144	
	96	144	
	82,9	91,8	
Hz	EUR		EUR
45...55	[3] M12732.	[4] M12742.	
	EUR 228,10	252,61	

2HLC, Double Reed type frequencymeters

Reed, 230 V

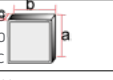
			
Tipo	2 HLC 96	2 HLC 144	
Class	0,5		
Scale	-		
 a b c	96	144	
	96	144	
	82,9	91,8	
Hz	EUR		EUR
47...53 Hz / 13 reed	[c] M1293200C0000	50,75	
57...63 Hz / 13 reed	[c] M1293200I0000	50,75	
46...54 Hz / 17 reed (*1)	[c] M129320080000	295,25	
56...64 Hz / 17 reed (*1)	[c] M129320090000	295,25	
45...55 Hz / 21 reed (*1)		[c] M129420060000	295,25
55...65 Hz / 21 reed (*1)		[c] M129420070000	295,25

(*1) Metal enclosure

CH

Hour run meters





Type	CH 48	CH 72	CH 96
Display	5 + 2		
	48	72	96
	48	72	96
	86,2	69,2	69,2
Code	[*] M14911.	[*] M14921.	[2] M14931.
EUR	31,03	71,64	73,45

MEG-1000

Insulation resistance meter

230 V (*), 50...60 Hz



Type	MEG-1000
Class	1,5
Scale	90°
Frequency	50...60 Hz
	96
aa	96
bb	96
cc	132
Ω (double Scales)	0...500 kΩ 0,5...5 MΩ
Code	[*] M15051.
EUR	460,70

(*) Power Supply 440 Vac +10% €

TABLE OF ADDITIONAL FEATURES

2 EC

Code	Internal code		
M 1 X X X X 0 0 X			
			↑ Delivery time + €
Nominal scale value (Full scale)			
400 (640)	0	-	-
440 (700)	1	3	-
660 (1050)	2	3	-
1000 (1600)	3	3	-
1200 (1920)	4	3	-
2500 (4000)	5	3	-
3000 (4800)	6	3	-
3300 (5280)	7	3	-
4000 (6400)	8	3	-
5000 (8000)	9	3	-
5500 (8800)	A	3	-
6600 (10560)	B	3	-
7200 (11520)	C	3	-
9000 (14400)	D	3	-
10000 (16000)	E	3	-
11000 (17600)	F	3	-
12500 (20000)	G	3	-
15000 (24000)	H	3	-
20000 (32000)	J	3	-
22000 (35200)	K	3	-
24000 (38400)	L	3	-
25000 (40000)	M	3	-

2HC frequencymeters

Code	Internal code		
M 1 X X X X 0 0 X X			
			↑ Delivery time + €
Frequency (Hz)			
Standard (45...55 Hz)	0	-	-
57...63	1	2	21,44
55...65	3	2	-
45...65	4	2	-
47...53	5	2	21,44
Voltage (V)			
Standard (230 V)	0	-	-
100 ... 120	1	3	8,81
380 ... 400	3	3	-
440	4	3	-

SMC, STC, UC

Code	Internal code		
M 1 X X X X 0 0 X			
			↑ Delivery time + €
Frequency			
Standard (50 Hz)	0	-	-
60 Hz	1	3	10,66

SynchroMAX

Code	Internal code		
M 1 X X X X 0 0 X			
			↑ Delivery time + €
Voltage supply			
Standard (400 V)	0	-	-
110 Vac	1	-	-
230 Vac	2	-	-
40...170 Vdc	D	2	197,25

2HLC frequencymeters

Code	Internal code		
M 1 X X X X 0 0 X X			
			↑ Delivery time + €
Voltage			
Standard (230 V)	0	-	-
100 V	7	3	-
110 V	8	3	-
400 V	9	3	-
440 V	4	3	-

CH

Code	Internal code		
M 1 X X X X 0 0 X X			
			↑ Delivery time + €
Frequency			
Standard 50 Hz	0	-	-
60 Hz	1	2	11,18
Voltage			
Standard (230 V)	0	-	-
24 Vc.a.	6	2	-
110 Vc.a.	1	2	-
10...80 Vc.c.	8	2	64,18
80...200 Vc.c.	A	2	64,18

Accessories / Options for analogue instruments

GENERAL options for analogue instruments

Type	Code	EUR
IP 54 airtight seal, 48 x 48	[1] M1ZZ52.	6,44
IP 54 airtight seal, 72 x 72	[1] M1ZZ53.	6,44
IP 54 airtight seal, 96 x 96	[1] M1ZZ54.	6,65
IP 54 airtight seal, 144 x 144	[1] M1ZZ55.	6,65
Protection IP 65, 48 x 48	[1] M19941.	32,86
Protection IP 65, 72 x 72	[1] M19942.	32,86
Protection IP 65, 96 x 96	[1] M19943.	32,86
Protection IP 65, 144 x 144	[1] M19944.	32,86
Terminal covers (IP 20) 48 x 48	[3] M19921.	2,38
Terminal covers (IP 20) 72x 72	[*] M19922.	2,38
Terminal covers (IP 20) 96 x 96	[*] M19923.	2,38

		M 1 X X X X 0 0 X X X X X			
			↑	↑	Delivery time + €
Other options	Tropical proof (assembly panel only)	0	1	2	5,92
	Externally regulated pointer	0	2	2	12,17
	Anti-reflection glass	0	3	2	3,34
	Makrolon glass	0	4	2	7,40
	Interior lighting (6-12-48 V dc) panel only	0	5	2	42,72
	Tropical proof + Anti-reflection glass	0	6	2	9,25
Tropical proof + Makrolon glass		0	7	2	13,33

Dimensions

EC / BC

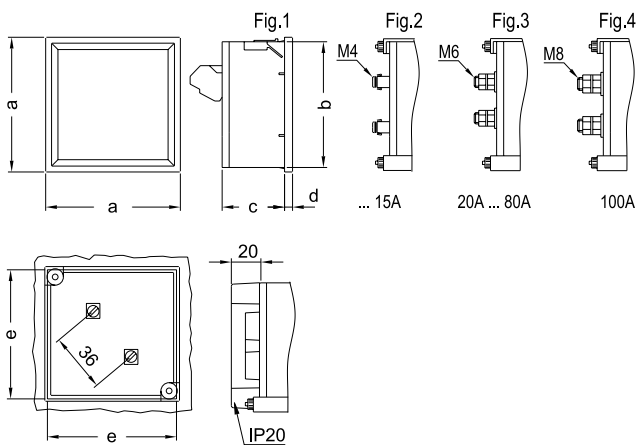

EZC / ZC

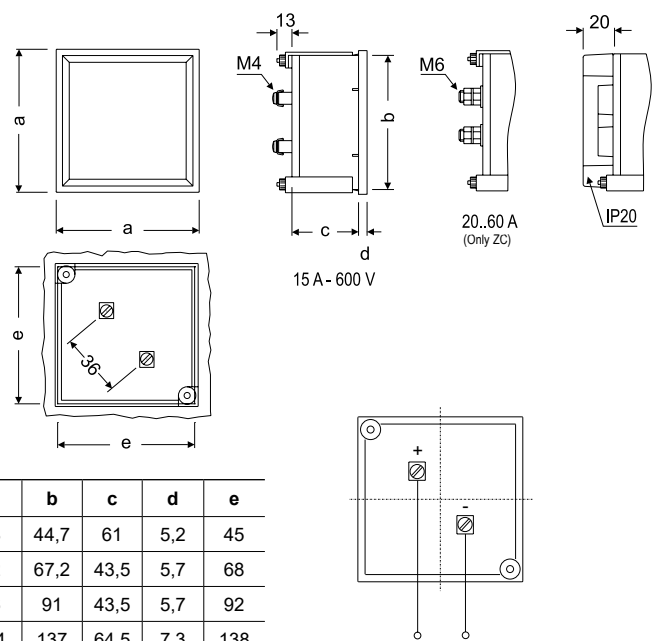

Typ	Fig. EC	Fig. BC	Fig. ZC	Fig. EZC	a	b	c	d	e
48	1-3	1-3	1	-	48	44,7	61	5,2	45
72	1-3-4	2-3-4	1	1	72	67,2	43,5	5,7	68
96	1-3-4	2-3-4	1	1	96	91	43,5	5,7	92
144	2-3-4	2-3-4	1	-	144	137	64,5	7,3	138

EC-FA, EC-F, EC-FN

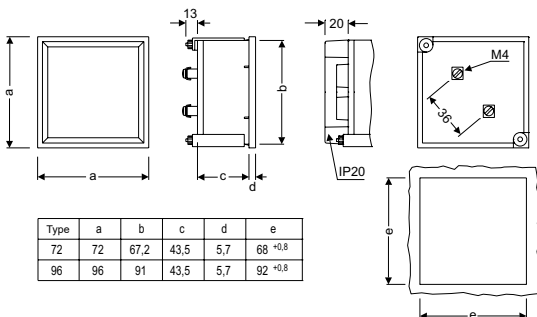

Type	a	b	c	d	e
72	72	67,2	43,5	5,7	68 ^{+0,8}
96	96	91	43,5	5,7	92 ^{+0,8}

EMSC 45 / BMSC 45 / HMSC 45

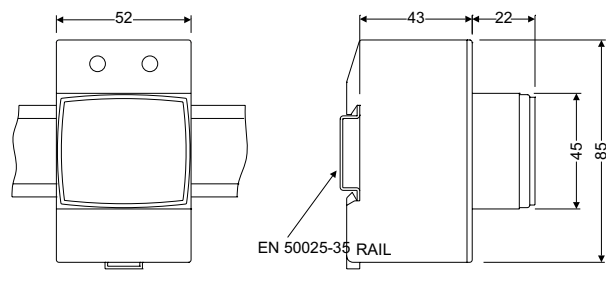

CEC / CBC / PGR

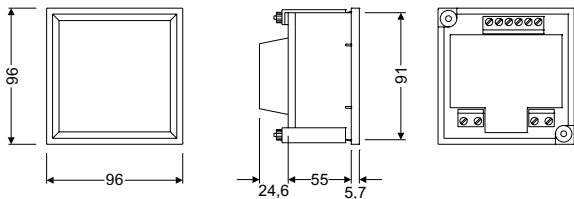

EMC / MC

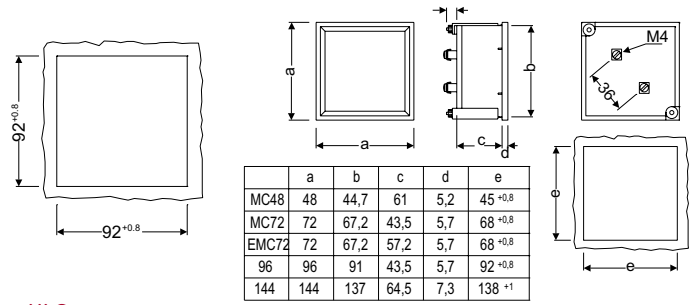

HC

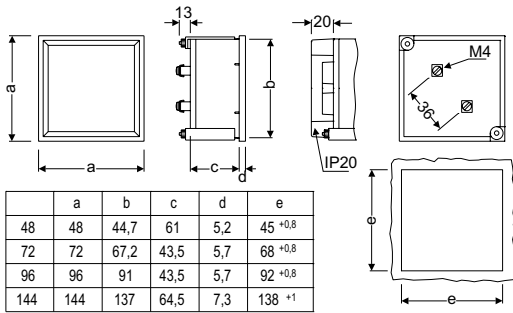

HLC

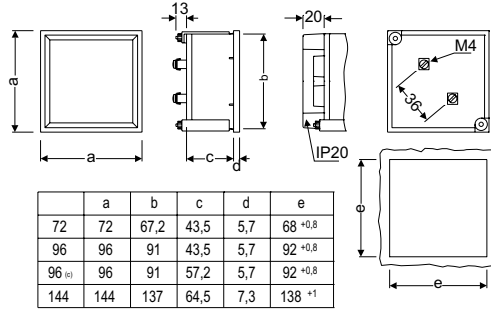

FEMC / FETC

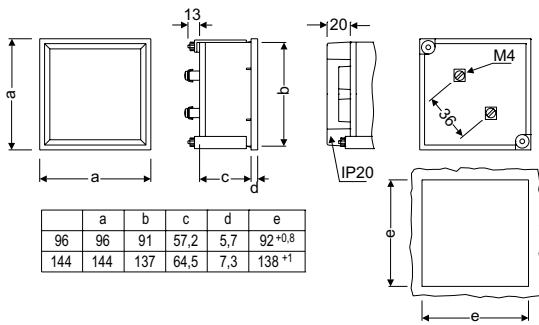

WMC / WTC

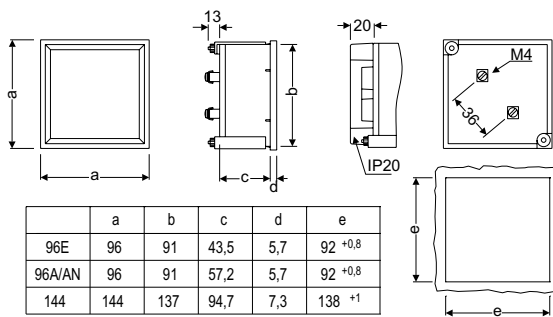

2 EC

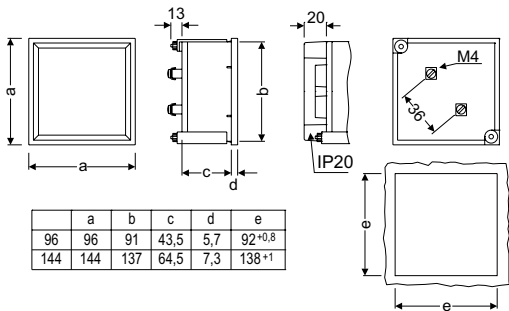

2 HC / 2 HLC

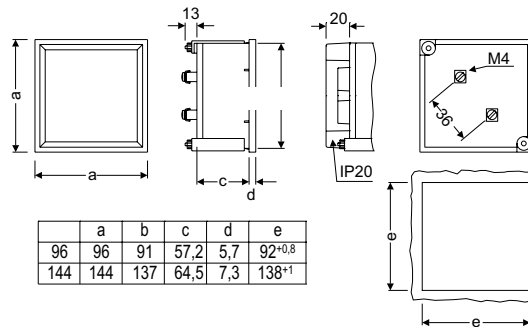

UC / CUC

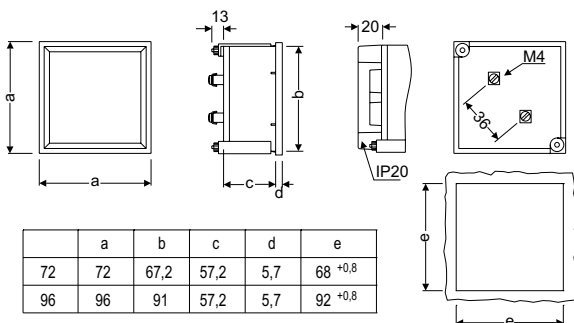

SMC / STC

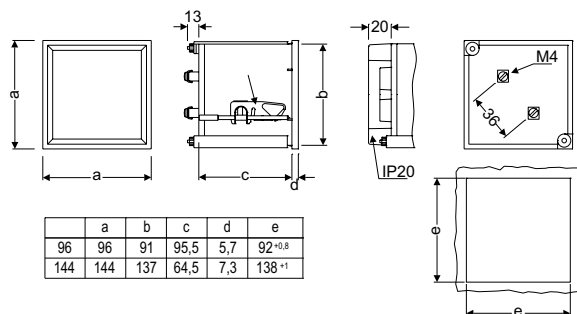

SYNCROMAX

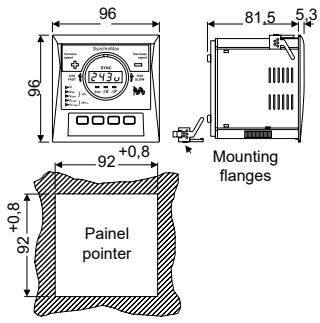

MEG-1000

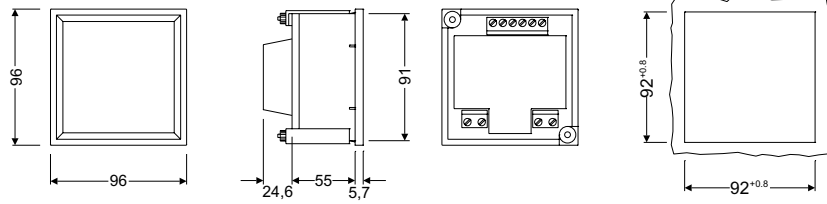

CH

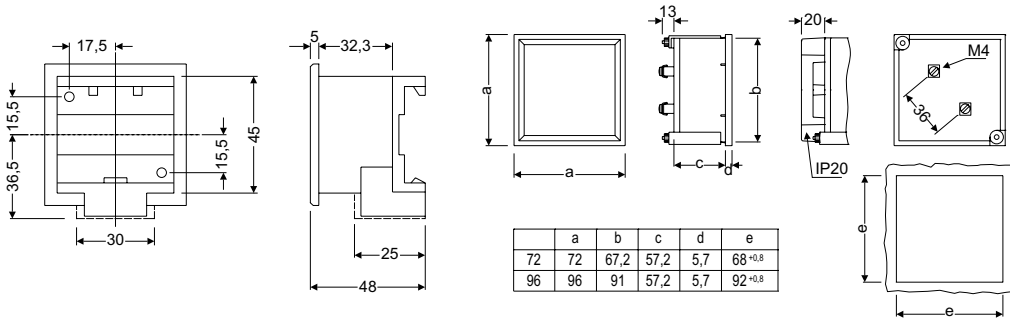

	a	b	c	d	e
72	72	67,2	57,2	5,7	68 ^{+0,8}
96	96	91	57,2	5,7	92 ^{+0,8}

Industrial IoT and Automation

EMS Datalogger and SCADA Embedded

Energy manager - Line system	70
Line-EDS-cloud Cloud data collection systems (Big Data).....	70
Line-M-4IO-T Expansion modules, Line series.....	70
Line-CVM-D Power analyzer, Line series.....	70
Gateway for DataBox platform.....	71
PowerStudio Universe, Energy management software	71
DATABOX, DataBox Cloud software.....	71

Converters and gateways

Input and Output Centralisers

Converters and gateways.....	72
Kit Line-TCPRS1/M Impulse centralisers.....	72
LM4I-4O Impulse and contact centralisers.....	72
LM-A Centralizer of analog and digital inputs and output relays	72

ARM edge controllers

eManager Essential, IoT programmable controllers.....	73
eManager ActIO, IoT programmable controllers with digital, analog inputs and relays	73
eManager Energy, IoT programmable controllers with integrated energy metering	73

ESP32 edge controllers

eCore Essential, ESP32 controller.....	74
--	----

EMS Datalogger and SCADA Embedded



Energy manager - Line system



Line-EDS-PS Data collection systems. Integrates WEBSITE.

Type	Code	Integrated Software	Transistor output	Generic Modbus	Communications	Protocol
Line-EDS-cloud	[*] D70050.	API's de: AZURE AWS GOOGLE DEXCELL MyCIRCUTOR SENTILO	2	●	Ethernet Wi-Fi RS-485 Bus-Line	Modbus API's web
Line-EDS-PS	[*] D70005.	PowerStudio	2	●	Ethernet Wi-Fi RS-485 Bus-Line	Modbus (Circutor + generic) XML
Line-EDS-PSS PRO	[*] D70020.	PowerStudio Scada PRO	2	●	Ethernet Wi-Fi RS-485 Bus-Line	Modbus (Circutor + generic) XML
Line-EDS-iMonitor	[*] D70021.	PowerStudio Scada PRO + iMonitor	2	●	Ethernet Wi-Fi RS-485 Bus-Line	Modbus (Circutor + generic) XML

Bus-Line: RS-485 communications system, with lateral side connector between modules



Line-M-4IO-A Expansion modules, Line series

Type	Code	Transistor output	Relay output	Digital inputs	Analogue Input	Analogue output	Communications	Protocol
Input/Output Modules								
Line-M-4IO-T	[*] D73001.	4	-	4	-	-	Bus-Line	Modbus/RTU
Line-M-4IO-R	[*] D73002.	-	4	4	-	-	Bus-Line	Modbus/RTU
Line-M-8I6O	[*] D73008.	-	6	8	-	-	Bus-Line	Modbus/RTU
Line-M-4IO-A	[*] D73003.	-	-	-	4 (0/4 ... 20 mA)	4 (0/4 ... 20 mA) 4 (0/2 ... 10 Vdc)	Bus-Line	Modbus/RTU
Line-M-4IO-RV	[*] D73004.	-	4	4 (230 V)	-	-	Bus-Line	Modbus/RTU
Line-M-20I	[C] D73006.	-	-	20	-	-	Bus-Line	Modbus/RTU

Analogue I/O expansion modules, Line series

Type	Code	Description
Power supply		
Line-M-EXT-PS	[*] D7300A.	110-277 V ~ (P-N)/110-480 V ~ (P-P) power supply for maximum of 3 Line devices
Modem		
Line-M-4G	[*] D7300C.	4G/GPRS Communications modem and Bus-Line to communicate with Line-EDS devices
Ethernet converter		
Line-TCPRS1	[C] D80030.	RS-485/RS-232 to Ethernet/Wi-Fi converter (ModbusTCP/TCP/UDP) Integrated web server and mobile app (MyConfig) for configuration

Line-TCPRS1: Power supply 100... 264 VAC/100... 300 VDC



Line-CVM-D Power analyzer, Line series

Type	Code	Measuring Channels	Input current	Transistor output	Communications	Protocol	Harmonics
Line-CVM-D32	[*] M58100.	3	.../5 A .../1 A .../250 mA	2	RS-485 Bus-Line	Modbus/RTU	40

Bus-Line: RS-485 communications system, with lateral side connector between modules

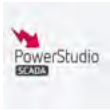

PowerStudio Universe, Energy management software

NEW

Type	Code	Description
SCADA software		
PowerStudio SCADA Basic	[*] W20100.	SCADA software for monitoring, control and analysis of installations, with CIRCUTOR devices and third-party Modbus equipment. Up to 25 devices
PowerStudio SCADA Pro	[*] W20110.	SCADA software for monitoring, control and analysis of installations, with CIRCUTOR devices and third-party Modbus equipment. Up to 50 devices
PowerStudio SCADA Ultimate	[*] W20120.	SCADA software for monitoring, control and analysis of installations, with CIRCUTOR devices and third-party Modbus equipment. Up to 500 devices.
PowerStudio SCADA Enterprise	[*] W20130.	SCADA software for monitoring, control and analysis of installations, with CIRCUTOR devices and third-party Modbus equipment. More than 500 devices.
OPC UA Server	[*] W20200.	Allows to configure an OPC UA server in PowerStudio for any SCADA with OPC UA client to integrate the desired parameters.
PS-DataBox	[*] W20300.	Connects PowerStudio software and DataBox cloud platform



DATABOX, DataBox Cloud software

DataBox data plans

Type	Code	Description
Plan		
LitePlan_Databox	[*] W10100.	6 Readings, 6 Alarms and 6 Actuators
SmallPlan_Databox	[*] W10101.	18 Readings, 18 Alarms and 18 Actuators
MediumPlan_Databox	[*] W10102.	55 Readings, 55 Alarms and 55 Actuators
BigPlan_Databox	[*] W10103.	100 Readings, 100 Alarms and 100 Actuators
User		
BasicUser_Databox	[*] W10110.	Viewing permissions
AdvancedUser_Databox	[*] W10111.	Viewing and editing permissions for graphical configuration and reports
AnalyticsUser_Databox	[*] W10112.	Permissions to view, analyse and edit graphical configuration and reports.
ProfessionalUser_Databox	[*] W10113.	Administrator permissions. A minimum of one user per partner is required
Service		
Act-Firmware_Databox	[*] W10120.	ePick GPRS VPN over-the-air firmware upgrade
ImportVar_Databox	[*] W10121.	Variable imported and stored in the platform
ModbusIntegration_Databox	[*] W10122.	Integration of a Modbus map of a new device
Brand_databox	[*] W10123.	Visual customisation of the platform (Name, DNS and background image)
API_Databox	[*] W10124.	Extensive use of the API. 1,000 first calls free of charge. Monthly charging of 25.000 calls packages.

All codes, with the exception of W10120, W10122, and W10124, correspond to monthly subscription prices. The prices for codes W10120, W10122, are one-time purchase prices. The price of code W10124, corresponds to 25,000 calls. A reading is understood as a variable that is periodically recorded, an alarm as an expression that is continuously evaluated locally and reported, and an actuator as a pre-configured (manual or programmed) remote control action.

Gateway for DataBox platform

Type	Code	Description
ePick GPRS VPN	[*] D60060.	Gateway with GPRS communications via VPN network and SIM card with worldwide coverage fully configured to send data from the units connected to the RS-485 port or Ethernet to the Databox cloud platform.
ePick GPRS NET	[*] D60070.	Gateway with GPRS communications (SIM card must be provided by the user) to send data from the units connected to the RS-485 port or Ethernet to the Databox cloud platform in order to carry out energy audits and improvements related to Electrical Energy Efficiency

Accessories

Antena mural	[C] Q4994M.	Indoor wall antenna 2.2 dBi 2m
Antena antivandálica	[C] Q4994N.	Antenna antivandalic IP67 4dBi 1m

Converters and gateways



Converters and gateways

Type	Code	Description
RS		
RS2RS	[*] D80310.	RS-232/485 Intelligent converter and amplifier (RTS control) for PC
USB		
USB-RS 485	[*] D80320.	USB to RS-485 Converter
M-BUS		
CMBUS-8	[*] D80208.	M-Bus to Modbus Converter, up to 8 Mbus slaves
CMBUS-24	[*] D80224.	M-Bus to Modbus Converter, up to 24 Mbus slaves
LoRa		
Bridge LR PSAC	[*] D80110.	LoRa to RS-485 Converter (Modbus/RTU) . AC power supply (110...264 Vac)
Bridge LR PSDC	[*] D80111.	LoRa to RS-485 Converter (Modbus/RTU) . DC power supply (9 ... 36 Vdc)
Ethernet		
TCPRS1+	[*] D80010.	RS-485 to Ethernet/Wi-Fi converter (ModbusTCP/TCP/UDP) Integrated web server and mobile app (MyConfig Wifi) for configuration
TCPRS1+PSDC	[*] D80011.	RS-485 to Ethernet/Wi-Fi converter (ModbusTCP/TCP/UDP) Integrated web server and mobile app (MyConfig Wifi) for configuration

Input and Output Centralisers



Kit Line-TCPRS1/M Impulse centralisers

Type	Code	Digital inputs	Communications	Protocol
Kit line-TCPRS1/M-20I	[C] D90030.	20	Ethernet WiFi	ModbusTCP TCP UDP
Kit line-TCPRS1/2xM-20I	[C] D90031.	40	Ethernet WiFi	ModbusTCP TCP UDP



LM4I-40 Impulse and contact centralisers

Type	Code	Relay output	Digital inputs	Communications	Protocol
LM4I-40-M	[*] D90110.	4	4	RS-485	Modbus/RTU

(*) Digital inputs (logic 0 / 1) or energy impulses

NEW

LM-A Centralizer of analog and digital inputs and output relays

Type	Code	Relay output	Digital inputs	Analogue Input	Analog output	Communications	Protocol
LM-A42-D11	[*] D90420.	1	1	4	2	RS-485	Modbus/RTU

(*) Digital inputs (logic 0 / 1) or energy impulses

ARM edge controllers



eManager Essential, IoT programmable controllers

Type	Code	CPU	Memory	Power supply	Communications	Módulos
eManager Essential						
eManager	[*] D20000.	ARM Cortex A7 Basic	256 MB 512 MB NAND	85 ... 264 V~	RS232/485 Ethernet Wi-Fi	5
eManager GPRS	[*] D20010.	ARM Cortex A7 Basic	256 MB 512 MB NAND	85 ... 264 V~	RS232/485 Ethernet Wi-Fi GPRS	5
eManager GPRS DC	[*] D20011.	ARM Cortex A7 Basic	256 MB 512 MB NAND	9...36 Vdc	RS232/485 Ethernet Wi-Fi GPRS	5
eManager Pro	[*] D30000.	ARM Cortex A7 Pro	512 MB 8 GB eMMC	85 ... 264 V~	RS232/485 Ethernet Wi-Fi	5
eManager Pro (DC)	[*] D30001.	ARM Cortex A7 Pro	512 MB 8 GB eMMC	9...36 Vdc	RS232/485 Ethernet Wi-Fi	5
eManager Pro GPRS	[*] D30010.	ARM Cortex A7 Pro	512 MB 8 GB eMMC	85 ... 264 V~	RS232/485 Ethernet Wi-Fi GPRS	5
eManager Pro 4G	[*] D30020.	ARM Cortex A7 Pro	512 MB 8 GB eMMC	85 ... 264 V~	RS232/485 Ethernet Wi-Fi 4G EMEA	5
eManager Pro 4G SC	[*] D3002000C0000	ARM Cortex A7 Pro	512 MB 8 GB eMMC	85 ... 264 V~	RS232/485 Ethernet Wi-Fi 4G EMEA	7
eManager Pro 4G (LATAM/AUX)	[*] D30030.	ARM Cortex A7 Pro	512 MB 8 GB eMMC	85 ... 264 V~	RS232/485 Ethernet Wi-Fi 4G LATAM,AUS,NZ	5



eManager ActIO, IoT programmable controllers with digital, analog inputs and relays

Type	Code	CPU	Memory	Power supply	Communications	Relay output	Digital inputs	Analogue Input	Temp Probe.	Módulos
eManager ActIO										
eManager ACTIO 1072	[*] D201000012000	ARM Cortex A7 Basic	256 MB 512 MB NAND	85 ... 264 V~	RS232/485 Ethernet Wi-Fi	2 (6 A)	10	7	-	7
eManager Pro ACTIO 1072	[*] D301000012000	ARM Cortex A7 Pro	512 MB 8 GB eMMC	85 ... 264 V~	RS232/485 Ethernet Wi-Fi	2 (6 A)	10	7	-	7
eManager Pro GPRS ACTIO 1072	[*] D301100012000	ARM Cortex A7 Pro	512 MB 8 GB eMMC	85 ... 264 V~	RS232/485 Ethernet Wi-Fi GPRS	2 (6 A)	10	7	-	7
eManager Pro GPRS ACTIO 80	[*] D301100030000	ARM Cortex A7 Pro	512 MB 8 GB eMMC	85 ... 264 V~	RS232/485 Ethernet Wi-Fi GPRS	8 (2 A)	-	-	-	6
eManager Pro 4G ACTIO 1072	[*] D301200012000	ARM Cortex A7 Pro	512 MB 8 GB eMMC	85 ... 264 V~	RS232/485 Ethernet Wi-Fi 4G EMEA	2 (6 A)	10	7	-	7
eManager Pro 4G ACTIO 221	[*] D301200060000	ARM Cortex A7 Pro	512 MB 8 GB eMMC	85 ... 264 V~	RS232/485 Ethernet Wi-Fi 4G EMEA	1 (6 A)	2	-	2	6
eManager ActIO Energy										
eManager Pro 4G ActIO 22172 Energy	[*] D3032000267000	ARM Cortex A7 Pro	512 MB 8 GB eMMC	85 ... 264 V~	RS232/485 Ethernet Wi-Fi 4G EMEA	3 (6 A)	2	7	2	9



eManager Energy, IoT programmable controllers with integrated energy metering

Type	Code	CPU	Memory	Power supply	Communications	System	Módulos
eManager Energy							
eManager Pro Energy	[2] D302000070000	ARM Cortex A7 Pro	512 MB 8 GB eMMC	85 ... 264 V~	RS232/485 Ethernet Wi-Fi	1 xThree-phase / 3 xSingle-phase	7
eManager Pro Energy X2	[*] D302000080000	ARM Cortex A7 Pro	512 MB 8 GB eMMC	85 ... 264 V~	RS232/485 Ethernet Wi-Fi	2 xThree-phase / 6 xSingle-phase	7
eManager Pro 4G Energy X2	[*] D302200080000	ARM Cortex A7 Pro	512 MB 8 GB eMMC	85 ... 264 V~	RS232/485 Ethernet Wi-Fi 4G EMEA	2 xThree-phase / 6 xSingle-phase	7

ESP32 edge controllers



eCore Essential, ESP32 controller

Type	Code	CPU	Memory	Power supply	Communications	Relay output	Digital inputs	Analogue Input	Módules
eCore Essential									
eCore	[*] D10000.	ESP32 Dual-core 32-bit 240 MHz	8 MB 16 MB	85 ... 264 V~	RS232/485 Ethernet Wi-Fi	-	-	-	4
eCore GPRS	[*] D10010.	ESP32 Dual-core 32-bit 240 MHz	8 MB 16 MB	85 ... 264 V~	RS232/485 Ethernet Wi-Fi GPRS	-	-	-	5
eCore Energy									
eCore GPRS Energy	[*] D102100090000	ESP32 Dual-core 32-bit 240 MHz	8 MB 16 MB	85 ... 264 V~	RS232/485 Ethernet Wi-Fi GPRS	-	-	-	7
eCore ActIO Energy									
eCore ActIO 22172 Energy	[*] D103000026700	ESP32 Dual-core 32-bit 240 MHz	8 MB 16 MB	85 ... 264 V~	RS232/485 Ethernet Wi-Fi	3 (6 A)	2	7	8

Dimensions

Kit Line-TCPRS1/M-20

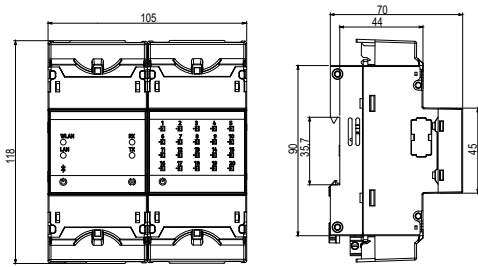

Kit Line-TCPRS1/2xM-20

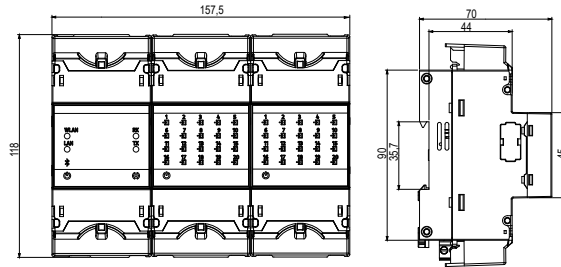

Line-EDS, line-CVM-D32, line-M, Line-TCPRS1

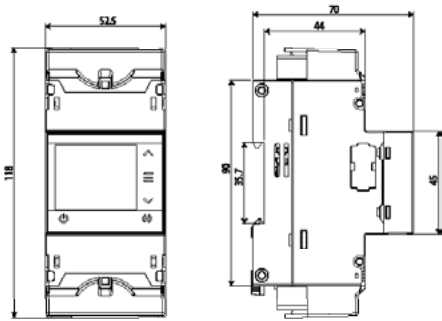

TCPRS1+

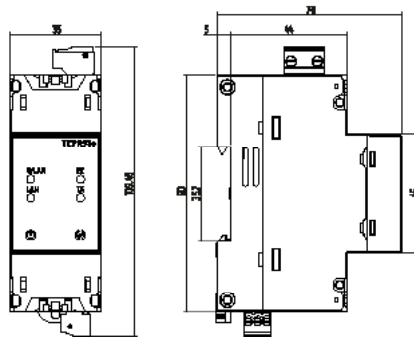

Metering

Multifunction electrical energy meters

Table: multi-function electrical energy meters Selection.....	78
CIRWATT B III, Three-phase energy meters (Measuring, load profiling, multi configurable billing calendar).....	79
CIRWATT B II, Single-phase energy meter	79

PRIME Remote Management

CIRWATT-repeater, Repeater for amplification of the PLC signal for the PRIME system.....	80
--	----

Advanced low voltage monitoring

R-SABT, Advanced Low-voltage Remote Monitoring	81
DSO Monitor_Scout, Scout software.....	81
CMBT-SABT, Advanced low-voltage monitoring cabinets	81

Accessories











kit3-TRMC210Kit of 3 current transformers for energy meters, primary winding.....	82
kit3-TRMC400Sets of 3 current transformers for energy meters.....	82
TRMCx3, Current transformers for energy meters	82
Modems, Communication accessories	83
LOC, CIRWATT optical reader.....	83
Converters and gateways.....	83

Partial consumption energy meters

Table: Selection of partial consumption electrical energy meters.....	85
CEM-C5 Direct Single-phase active energy meter.....	85
CEM-C12c Direct Single-phase energy meter with basic analyser parameters	85
CEM-C Energy meter	86
Converters and gateways.....	87
PowerStudio Universe, Energy management software	87
DATABOX, DataBox Cloud software.....	87

Multifunction electrical energy meters

Table: multi-function electrical energy meters Selection

		B502	B505	B410T	B410D	B410TP	B410DP	B410 RCP	B200 RCP	B101	B102
											
Connection	2 wires	-	-	-	-	-	-	-	•	•	•
	4 wires Direct	-	-	-	•	•	-	•	-	-	-
	3/4 wires Indirect	•	•	•	-	-	•	-	-	-	-
Measurement	4 Quadrants	•	•	•	•	•	•	•	•	•	•
Voltage	1x230 V _{ca}	-	-	-	-	-	-	-	•	•	•
	3x63,5/110 V _{ca}	T	T	T	-	-	-	-	-	-	-
	3x127/220 V _{ca}	T	T	T	T	T	T	T	-	-	-
	3x230/400 V _{ca}	T	T	T	T	T	T	T	-	-	-
	3x127/220 V _{ca} ...3x230/400 V _{ca}	-	-	-	T	-	-	-	-	-	-
	3x57/100 V _{ca} ...3x230/400 V _{ca}	T	T	T	-	-	-	-	-	-	-
Frequency	50 Hz	T	T	T	T	T	T	T	T	T	T
	60 Hz	T	T	T	T	T	T	T	T	T	T
Protocol	IEC 870	•	•	•	•	-	-	-	-	-	-
	DLMS	-	-	-	-	•	•	•	•	-	-
	IEC 62056-21	-	-	-	-	-	-	-	-	•	T
	Modbus/RTU	•	•	•	•	-	-	-	-	-	T
Communications	RS-485	-	-	-	-	-	-	-	-	-	•
	PRIME	-	-	-	-	•	•	•	•	-	-
	RS-232/232	T	T	T	T	-	-	-	-	-	-
	RS-485/485	T	T	T	T	-	-	-	-	-	-
	RS-232/485	T	T	T	T	-	-	-	-	-	-
	RS-232/Ethernet	T	T	T	T	-	-	-	-	-	-
	RS-485/Ethernet	T	T	T	T	-	-	-	-	-	-
Circuit breaker		-	-	-	-	-	-	•	•	-	-

OP - Optional / T - According to type



CIRWATT B III, Three-phase energy meters (Measuring, load profiling, multi configurable billing calendar)

Type	Code	Class (Active/Reactive)	Quadrants	Measurement Range (V)	Measurement Range (A)	Freq. (Hz)	Communications
CIRWATT B 502							
402-MT5A-90B10	[1] QBP1A.	0.2S/0.5	4	3x63,5/110	.../5	50	RS-232 RS-485
402-MT5A-80B10	[1] QBP1Q.	0.2S/0.5	4	3x63,5/110	.../5	50	RS-485 RS-485
402-MT5A-A0B10	[1] QBP1B.	0.2S/0.5	4	3x63,5/110	.../5	50	RS-232 Ethernet
402-MT5B-90B10	[1] QBP1C	0.2S/0.5	4	3x63.5/110	.../5	60	RS-232 RS-485
402-MT5B-A0B10	[1] QBP1D	0.2S/0.5	4	3x63.5/110	.../5	60	RS-232 Ethernet
CIRWATT B 505							
405-VT7A-90B10	[1] QBN00	C (0,5S)/1	4	3x57/100 ... 3x230/400	.../ 1	50	RS-232 RS-485
405-VT7A-A0B10	[1] QBN10	C (0,5S)/1	4	3x57/100 ... 3x230/400	.../ 1	50	RS-232 Ethernet
405-VT7B-90B10	[1] QBN30	C (0,5S)/1	4	3x57/100 ... 3x230/400	.../ 1	60	RS-232 RS-485
410-VT7B-A0B10	[1] QBN40	C (0,5S)/1	4	3x57/100 ... 3x230/400	.../ 1	60	RS-232 Ethernet
CIRWATT B 410T							
410-QT5A-80B10	[1] QB8A0	B (1) / 2	4	3x230/400	.../5	50	RS-485 RS-485
410-QT5A-90B10	[1] QB870	B (1) / 2	4	3x230/400	.../5	50	RS-232 RS-485
410-QT5A-A0B10	[1] QB880	B (1) / 2	4	3x230/400	.../5	50	RS-232 Ethernet
410-VT5A-90B10	[1] QB10	B (1) / 2	4	3x57/100 ... 3x230/400	.../5	50	RS-232 RS-485
410-VT5A-A0B10	[1] QB120	B (1) / 2	4	3x57/100 ... 3x230/400	.../5	50	RS-232 Ethernet
410-QT5B-90B10	[1] QB8D0	B (1) / 2	4	3x230/400	.../5	60	RS-232 RS-485
410-QT5B-A0B10	[1] QB8E0	B (1) / 2	4	3x230/400	.../5	60	RS-232 Ethernet
410-VT5B-90B10	[1] QB160	B (1) / 2	4	3x57/100 ... 3x230/400	.../5	60	RS-232 RS-485
410-VT5B-A0B10	[1] QB170	B (1) / 2	4	3x57/100 ... 3x230/400	.../5	60	RS-232 Ethernet
410-QT7A-90B10	[1] QBN0B	B (1) / 2	4	3x230/400	.../ 1	50	RS-232 RS-485
410-QT7A-A0B10	[1] QBN1B	B (1) / 2	4	3x230/400	.../ 1	50	RS-232 Ethernet
410-VT7A-90B10	[1] QBN0J	B (1) / 2	4	3x57/100 ... 3x230/400	.../ 1	50	RS-232 RS-485
410-VT7A-A0B10	[1] QBN1J	B (1) / 2	4	3x57/100 ... 3x230/400	.../ 1	50	RS-232 Ethernet
410-QT7B-90B10	[1] QBN2B	B (1) / 2	4	3x230/400	.../ 1	60	RS-232 RS-485
410-QT7B-A0B10	[1] QBN3B	B (1) / 2	4	3x230/400	.../ 1	60	RS-232 Ethernet
410-VT7B-90B10	[1] QBN2J	B (1) / 2	4	3x57/100 ... 3x230/400	.../ 1	60	RS-232 RS-485
410-VT7B-A0B10	[1] QBN3J	B (1) / 2	4	3x57/100 ... 3x230/400	.../ 1	60	RS-232 Ethernet
CIRWATT B 410D							
410-QD1A-80B10	[1] QB4E0	B (1) / 2	4	3x230/400	10 (100)	50	RS-485 RS-485
410-QD1A-90B10	[1] QB4B0	B (1) / 2	4	3x230/400	10 (100)	50	RS-232 RS-485
410-QD1A-A0B10	[1] QB4C0	B (1) / 2	4	3x230/400	10 (100)	50	RS-232 Ethernet
410-QD1B-90B10	[1] QB4H0	B (1) / 2	4	3x230/400	10 (100)	60	RS-232 RS-485
410-QD1B-A0B10	[1] QB4I0	B (1) / 2	4	3x230/400	10 (100)	60	RS-232 Ethernet



CIRWATT B II, Single-phase energy meter

Type	Code	Class (Active/Reactive)	Quadrants	Measurement Range (V)	Measurement Range (A)	Freq. (Hz)	Tariff	Impulse output	Output relay	Change tariff input	Certification	Communications
CIRWATT B101												
210-ES7A-01B20	[1] QBMO3	B (1)	Abs.	230	5 (65)	50	3	1	-	-	IEC	-
210-ES7A-0EB20	[1] QBMO7	B (1)	Abs.	230	5 (65)	50	2	-	-	1	IEC	-
CIRWATT B102												
212-ES7A-21B20	[1] QBMD3	B (1) / 2	Abs.	230	5 (65)	50	3	1	-	-	IEC	RS-485 (IEC 62056-21)
212-ES7A-23B20	[1] QBMD5	B (1) / 2	Abs.	230	5 (65)	50	3	-	1	-	IEC	RS-485 (IEC 62056-21)
212-ES7A-2EB20	[1] QBMD7	B (1) / 2	Abs.	230	5 (65)	50	2	-	-	1	IEC	RS-485 (IEC 62056-21)
212-ES7A-21B20	[1] QBMD3	B (1) / 2	Abs.	230	5 (65)	50	3	1	-	-	IEC	RS-485 (Modbus/RTU)
212-ES7A-23B20	[1] QBMD5	B (1) / 2	Abs.	230	5 (65)	50	3	-	1	-	IEC	RS-485 (Modbus/RTU)
212-ES7A-2EB20	[1] QBMD7	B (1) / 2	Abs.	230	5 (65)	50	2	-	-	1	IEC	RS-485 (Modbus/RTU)

PRIME Remote Management



GEDE EDC, PRIME PLC Concentrator

Type	Code	Digital inputs	Communications	LV supervisor	2° transformer connection	Size (mm) width x height x depth
GEDE EDC	[1] Q67000.	-	PRIME	No	-	127x120x130
GEDE EDC-T 4G	[1] Q67550.	-	PRIME 4G	1	-	203x120x130
GEDE EDC-T 4I/4O	[1] Q675A0	4	PRIME	1	-	203x120x130
GEDE EDC-T 4I	[1] Q67540.	4	PRIME	1	-	203x120x130
GEDE EDC-T	[1] Q67500.	-	PRIME	1	-	165x120x130
GEDE EDC-2T	[1] Q67570.	-	PRIME	1	●	279x120x130
GEDE EDC TGU	[1] Q67080.	-	PRIME	1	-	216x132x135



CIRWATT-repeater, Repeater for amplification of the PLC signal for the PRIME system

Type	Code	Description
CIRWATT Repeater	[C] QM4011.	Three-phase repeater to amplify the PLC system of the PRIME system (3 x 127/200 ... 3 x 230/ 400 V)

Advanced low voltage monitoring



R-SABT, Advanced Low-voltage Remote Monitoring

Type	Code	Description
Advanced Low-voltage Remote Monitoring		
R-SABT	[C] Q46300.	Advanced low voltage remote monitoring
Exit Kits		
Kit CAP JNM_PNZ 400A	[C] Q32803.	Low voltage sensor kit for 400A three-pole base, Jean Müller/Pinazo + T-SABT
Kit CAP -PRO ORM 400A	[C] Q32802.	Low voltage sensor kit for 400A three-pole base, Pronutec/Ormazabal + T-SABT
Kit CAP CDY 400A	[C] Q32801.	Low voltage sensor kit for 400A three-pole base, Crady + T-SABT
Kit TQ	[C] Q32810.	Split core current transformer kit, push-button opening, 3x400/1A + T-SABT
Kit Rogowski	[C] Q32820.	100 mV/kA Rogowski clamp kit, 25 cm long, 3 metre cable + T-SABT Flex
Advanced Monitoring Accessories		
VTN	[C] Q32200.	Neutral to earth voltage monitor
	[] Q32103.	Neutral extension plate



DSO Monitor_Scout, Scout software

Cloud-Scout Electrical monitoring and auditing software

Type	Code	Description
DSO Monitor_Scout	[*] W10330.	Module for monitoring and operation of transformer substations

Module prices are annual subscription prices per connected device.
Equipment compatible with the modules: DSO Monitor: R-SABT.



CMBT-SABT, Advanced low-voltage monitoring cabinets

Type	Code	Device	Surge Protection (SPD)	Cabinet	Communications	Size (mm) width x height x depth
Indoor						
CMBT-SABT-INT-1	[C] Q5WGCO.	1 R-SABT	-	Reinforced polyester	Ethernet	360x315x180
CMBT SABT-INT-2	[C] Q5WLJO.	1 R-SABT 1 VTN	●	Reinforced polyester	Ethernet	360x315x180
Outdoor						
CMBT-SABT-TP-EXT-1	[C] Q54LL40080100	1 R-SABT 1 T-SABT PANEL 1 VTN	●	Reinforced polyester	Ethernet 4G	600x500x250
CMBT-SABT-TP-EXT-2	[C] Q54LL40080200	1 R-SABT 2 T-SABT PANEL 1 VTN	●	Reinforced polyester	Ethernet 4G	600x500x250
CMBT-SABT-TP-EXT-3	[C] Q54LL40080300	1 R-SABT 3 T-SABT PANEL 1 VTN	●	Reinforced polyester	Ethernet 4G	600x500x250

CMBT-SABT-ext requires current transformers that are not included (3 transformers with .../1 A secondary for each LV output)

Accessories

kit3-TRMC210 Kit of 3 current transformers for energy meters, primary winding

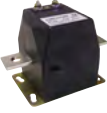
Type	kit3-TRMC210			kit3-TRMC210-05			kit3-TRMC210.2		
	Size (mm) width xheight xdepth 145x110x86								
A	Class	VA	Code	Class	VA	Code	Class	VA	Code
100/5	0.5S	10	[3] Q309010000001	0.5	10	[3] Q309610000001	0.5S	2,5	[3] Q309810000001
150/5	0.5S	10	[3] Q309020000001	0.5	10	[3] Q309620000001	0.5S	2,5	[3] Q309820000001
200/5	0.5S	10	[3] Q309030000001	0.5	10	[3] Q309630000001	0.5S	2,5	[3] Q309830000001
300/5	0.5S	10	[3] Q309040000001	0.5	10	[3] Q309640000001	0.5S	2,5	[3] Q309840000001
400/5	0.5S	10	[3] Q309050000001	0.5	10	[3] Q309650000001	0.5S	2,5	[3] Q309850000001
500/5	0.5S	10	[3] Q309060000001	0.5	10	[3] Q309660000001	0.5S	2,5	[3] Q309860000001
600/5	0.5S	10	[3] Q309070000001	0.5	10	[3] Q309670000001	0.5S	2,5	[3] Q309870000001

Consulter disponibilité.../1 A

kit3-TRMC400 Sets of 3 current transformers for energy meters

Type	kit3-TRMC400			kit3-TRMC400-05			kit3-TRMC400.2		
	Size (mm) width xheight xdepth 99x160x68								
Flat strip (mm)	100x20 mm								
A	Class	VA	Code	Class	VA	Code	Class	VA	Code
750/5	0.5S	10	[3] Q309110000001	0.5	10	[3] Q309710000001	0.5S	2,5	[3] Q309A10000001
1000/5	0.5S	10	[3] Q309120000001	0.5	10	[3] Q309720000001	0.5S	2,5	[3] Q309A20000001
1500/5	0.5S	10	[3] Q309130000001	0.5	10	[3] Q309730000001	0.5S	2,5	[3] Q309A30000001
2000/5	0.5S	10	[3] Q309140000001	0.5	10	[3] Q309740000001	0.5S	2,5	[3] Q309A40000001
3000/5							0.5S	2,5	[3] Q309A60000001

Consulter disponibilité.../1 A



TRMCx3, Current transformers for energy meters

Type	Code	Measurement Range (A)	Class 0,5S Power (VA)	Usefull diam.(mm)	Cable (m)
Outdoor					
TRMC-X3 100/5 Ext	[C] Q301T1010E000	100/5	2.5	38	7
TRMC-X3 200/5 Ext	[C] Q301T2010E000	200/5	2.5	38	7
TRMC-X3 300/5-Ext	[C] Q301T3010E000	300/5	2.5	38	7
TRMC-X3 400/5 Ext	[C] Q301T4010E000	400/5	2.5	38	7



LOC, CIRWATT optical reader

Type	Code	Description
Loc-USB	[*] Q30302.	CIRWATT optical reader with USB port



Modems, Communication accessories

Type	Code	Description
Router 4G/LTE Wifi	[*] Q30235.	Router 4G/LTE Wifi (includes PS + antenna + cable+DIN rail acces.)
Router 4G/LTE Wifi/DualSIM	[] Q3022x.	Router 4G/LTE Wifi (includes PS + antenna + cable+DIN rail acces.)
ANTENA	[1] Q4994E.	Antenna 9 dB (for GSM modem)

Dimensions

CIRWATT B502 / 505 / 410T / 410D

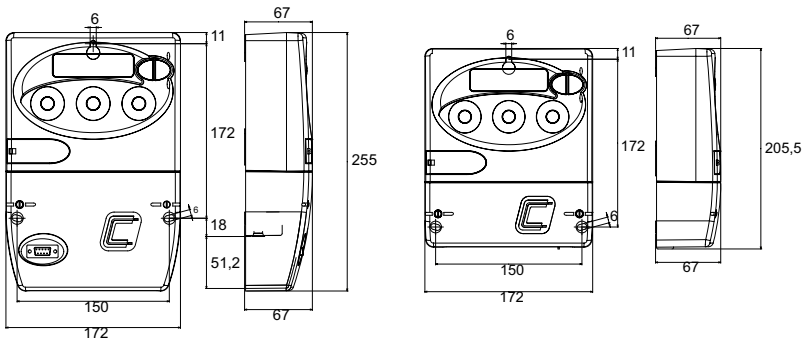

CIRWATT B 101 / 102 / 200 RCP

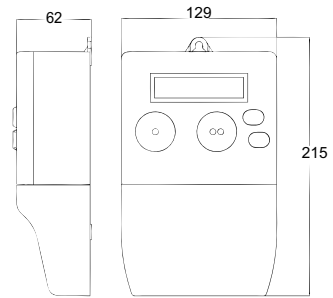

CIRWATT B 410 RCP

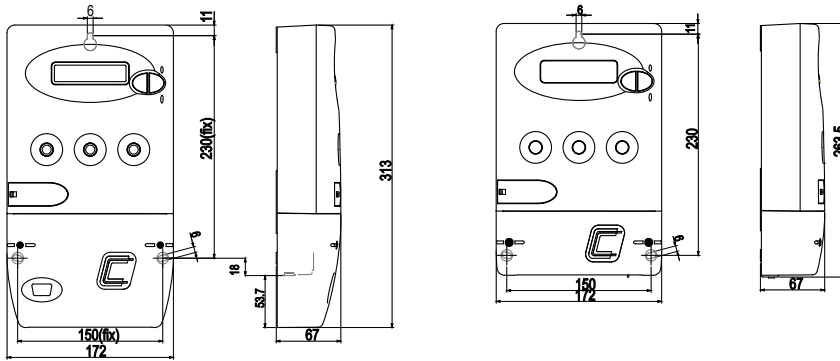

Compact DC + SBT

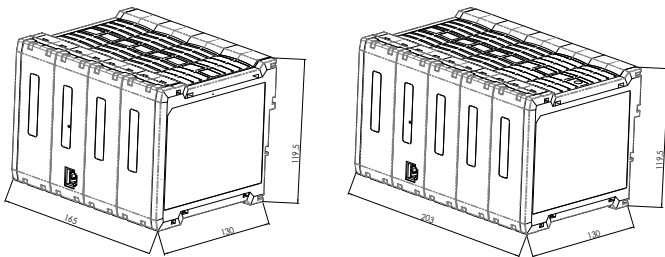

R-SABT

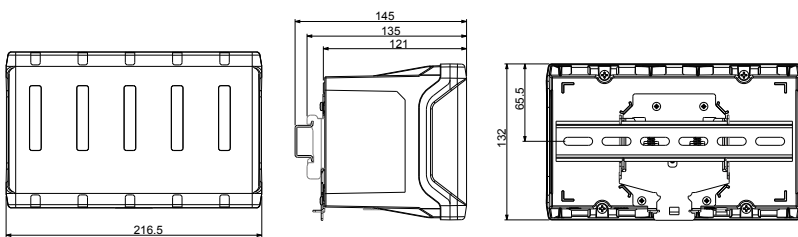

T-SABT

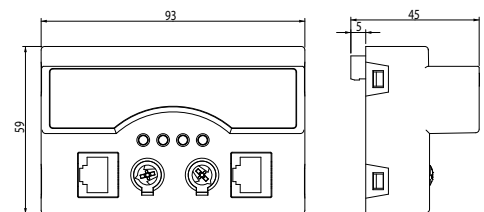



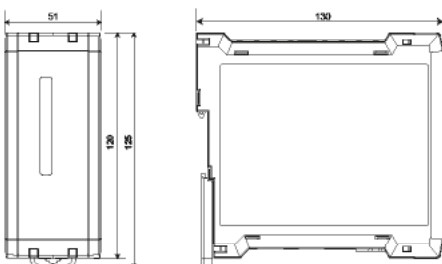



VTN



Partial consumption energy meters

Table: Selection of partial consumption electrical energy meters

		CEM-C5	CEM-C12	CEM-C21-T1	CEM-C21-DS	CEM-C31-T1	CEM-C31-DS
							
Mounting	DIN rail (modules)	1	1	3	3	3	3
AC measurement	Three-phase 3/4 wires	-	-	•	•	•	•
	Single-phase	•	•	-	-	-	-
	Quadrants	2	4	ABS	ABS	ABS	ABS
Parameters	Active energy (kWh)	•	•	•	•	•	•
	Reactive energy (kvarh)	-	•	•	•	•	•
	V, A, W, Hz, FP	-	•	•	•	•	•
	Tariffs	1	1	1	2	1	2
	Cost	-	-	•	•	•	•
	CO ₂ emissions	-	-	•	•	•	•
	Working time	-	-	•	•	•	•
Current Input	Direct	5 (50) A	10 (100) A 5 (100) A MID	5 (60) A 10(60) A	5 (60) A 10(60) A	-	-
	Indirect	-	-	-	-	.../5(10) A	.../5(10) A
Communications	RS-485	-	•	T	•	T	•
	Ethernet	-	-	OP (T)	OP (T)	OP (T)	OP (T)
Inputs/outputs	Digital inputs	-	-	-	1	-	1
	Digital outputs	1	-	1	-	1	-
Optional	MID certification	-	• (T)	• (T)	• (T)	• (T)	• (T)
	IEC certification	•	• (T)	• (T)	• (T)	• (T)	• (T)
	Auxiliary power supply	-	-	•	•	•	•
	Sealable	•	•	•	•	•	•

T - Depending on the Type/ OP - Optional



CEM-C5 Direct Single-phase active energy meter

Type	Code	Quadrants	Measurement Range (V)	Measurement Range (A)	Transistor output	Certification	Módules	Display
CEM-C5	[*] Q25112.	2	1 x 230	5 (50) A	1	IEC	1	LCD

Frequency: 50/60 Hz. Parameters: kWh



CEM-C12c Direct Single-phase energy meter with basic analyser parameters

Type	Code	Quadrants	Measurement Range (V)	Measurement Range (A)	Freq. (Hz)	Tariff	Certification	Módules	Communications	Protocol
CEM-C12c	[*] Q27211.	4	1 x 230	5 (100) A	50/60	1	IEC	1	RS-485	Modbus/RTU
CEM-C12c	[*] Q272110020000	4	1 x 127	5 (100) A	60 Hz.	1	IEC	1	RS-485	Modbus/RTU
CEM-C12c-MID	[*] Q27212.	4	1 x 230	0.25 ... 5 (100) A	50/60	1	MID	1	RS-485	Modbus/RTU

Parameters: V, A, kW, kVA, kWh, cos phi



CEM-C Energy meter

Power supply 230 Vac, 50 ... 60 Hz

Type	Code	Quadrants	Measurement Range (V)	Measurement Range (A)	I Max. (A)	Tariff	Tr. output	Digital inputs	Certification	Mód-ules	Comm-unications	Protocol
Direct three-phase												
CEM-C21-T1	[*] Q22411.	Abs.	3 x 127/220...3 x 230/400	5 (65) A	65	1	1	-	IEC	4	-	-
CEM-C21-485-T1	[*] Q22421.	Abs.	3 x 127/220...3 x 230/400	5 (65) A	65	1	1	-	IEC	4	RS-485	Modbus/RTU
CEM-C21-485-DS	[*] Q22431.	Abs.	3 x 127/220...3 x 230/400	5 (65) A	65	2	-	1	IEC	4	RS-485	Modbus/RTU
CEM-C21-T1-MID	[*] Q22412.	Abs.	3 x 127/220...3 x 230/400	5 (65) A	65	1	1	-	MID	4	-	-
CEM-C21-485-T1-MID	[*] Q22422.	Abs.	3 x 127/220...3 x 230/400	5 (65) A	65	1	1	-	MID	4	RS-485	Modbus/RTU
CEM-C21-485-DS-MID	[*] Q22432.	Abs.	3 x 127/220...3 x 230/400	5 (65) A	65	2	-	1	MID	4	RS-485	Modbus/RTU
Indirect three-phase												
CEM-C31-T1	[*] Q23511.	Abs.	3 x 57/100...3 x 230/400	.../ 5 (10) A	10	1	1	-	IEC	4	-	-
CEM-C31-485-T1	[*] Q23521.	Abs.	3 x 57/100...3 x 230/400	.../ 5 (10) A	10	1	1	-	IEC	4	RS-485	Modbus/RTU
CEM-C31-485-DS	[*] Q23531.	Abs.	3 x 57/100...3 x 230/400	.../ 5 (10) A	10	2	-	1	IEC	4	RS-485	Modbus/RTU
CEM-C31-T1-MID	[*] Q23512.	Abs.	3 x 57/100...3 x 230/400	.../ 5 (10) A	10	1	1	-	MID	4	-	-
CEM-C31-485-T1-MID	[*] Q23522.	Abs.	3 x 57/100...3 x 230/400	.../ 5 (10) A	10	1	1	-	MID	4	RS-485	Modbus/RTU
CEM-C31-485-DS-MID	[*] Q23532.	Abs.	3 x 57/100...3 x 230/400	.../ 5 (10) A	10	2	-	1	MID	4	RS-485	Modbus/RTU

CEM-C10 and CEM-C21/C31 without built-in RS-485 communications can optionally communicate with CEM-M-ETH and CEM-M-RS485 modules.

Devices with absolute measurements (Abs). For 2 or 4 quadrants, see the Additional table

Frequency: 50/60 Hz. Parameters: V, A, kW, kVA, kWh, cos phi

CEM-XXX-T1 encoding table - Devices with pulse output (transistor)

CEM-XXX-DS-Devices with digital input for tariff change and impulse meter

TABLE OF ADDITIONAL FEATURES

CEM-10 / CEM-C21/ CEM-C31

Q	2	X	X	X	X	0	0	X	X	X	X	X	
Code	Internal code										↑	↑	Delivery time
	Standard (ABS)										0	0	-
Quadrants	2										0	1	2
	4										0	2	2

ABS = Energy Consumed + Energy Generated



Converters and gateways

Type	Code	Description
RS		
RS2RS	[*] D80310.	RS-232/485 Intelligent converter and amplifier (RTS control) for PC
USB		
USB-RS 485	[*] D80320.	USB to RS-485 Converter
M-BUS		
CMBUS-8	[*] D80208.	M-Bus to Modbus Converter, up to 8 Mbus slaves
CMBUS-24	[*] D80224.	M-Bus to Modbus Converter, up to 24 Mbus slaves
LoRa		
Bridge LR PSAC	[*] D80110.	LoRa to RS-485 Converter (Modbus/RTU) . AC power supply (110...264 Vac)
Bridge LR PSDC	[*] D80111.	LoRa to RS-485 Converter (Modbus/RTU) . DC power supply (9 ... 36 Vdc)
Ethernet		
TCPRS1+	[*] D80010.	RS-485 to Ethernet/Wi-Fi converter (ModbusTCP/TCP/UDP) Integrated web server and mobile app (MyConfig Wifi) for configuration
TCPRS1+PSDC	[*] D80011.	RS-485 to Ethernet/Wi-Fi converter (ModbusTCP/TCP/UDP) Integrated web server and mobile app (MyConfig Wifi) for configuration

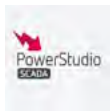

PowerStudio Universe, Energy management software

Type	Code	Description
SCADA software		
PowerStudio SCADA Basic	[*] W20100.	SCADA software for monitoring, control and analysis of installations, with CIRCUTOR devices and third-party Modbus equipment. Up to 25 devices
PowerStudio SCADA Pro	[*] W20110.	SCADA software for monitoring, control and analysis of installations, with CIRCUTOR devices and third-party Modbus equipment. Up to 50 devices
PowerStudio SCADA Ultimate	[*] W20120.	SCADA software for monitoring, control and analysis of installations, with CIRCUTOR devices and third-party Modbus equipment. Up to 500 devices.
PowerStudio SCADA Enterprise	[*] W20130.	SCADA software for monitoring, control and analysis of installations, with CIRCUTOR devices and third-party Modbus equipment. More than 500 devices.
OPC UA Server	[*] W20200.	Allows to configure an OPC UA server in PowerStudio for any SCADA with OPC UA client to integrate the desired parameters.
PS-DataBox	[*] W20300.	Connects PowerStudio software and DataBox cloud platform

NEW



DATABOX, DataBox Cloud software

DataBox data plans

Type	Code	Description
Plan		
LitePlan_Databox	[*] W10100.	6 Readings, 6 Alarms and 6 Actuators
SmallPlan_Databox	[*] W10101.	18 Readings, 18 Alarms and 18 Actuators
MediumPlan_Databox	[*] W10102.	55 Readings, 55 Alarms and 55 Actuators
BigPlan_Databox	[*] W10103.	100 Readings, 100 Alarms and 100 Actuators
User		
BasicUser_Databox	[*] W10110.	Viewing permissions
AdvancedUser_Databox	[*] W10111.	Viewing and editing permissions for graphical configuration and reports
AnalyticsUser_Databox	[*] W10112.	Permissions to view, analyse and edit graphical configuration and reports.
ProfessionalUser_Databox	[*] W10113.	Administrator permissions. A minimum of one user per partner is required
Service		
Act-Firmware_Databox	[*] W10120.	ePick GPRS VPN over-the-air firmware upgrade
ImportVar_Databox	[*] W10121.	Variable imported and stored in the platform
ModbusIntegration_Databox	[*] W10122.	Integration of a Modbus map of a new device
Brand_databox	[*] W10123.	Visual customisation of the platform (Name, DNS and background image)
API_Databox	[*] W10124.	Extensive use of the API. 1,000 first calls free of charge. Monthly charging of 25.000 calls packages.

All codes, with the exception of W10120, W10122, and W10124, correspond to monthly subscription prices. The prices for codes W10120, W10122, are one-time purchase prices. The price of code W10124, corresponds to 25,000 calls. A reading is understood as a variable that is periodically recorded, an alarm as an expression that is continuously evaluated locally and reported, and an actuator as a pre-configured (manual or programmed) remote control action.

Dimensions

CEM-C5

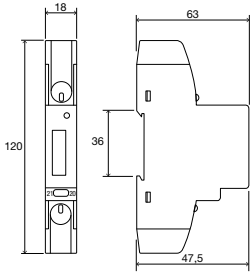

CEM-C12c

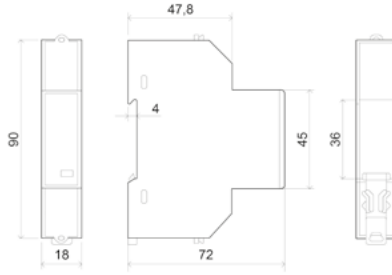

CEM-M

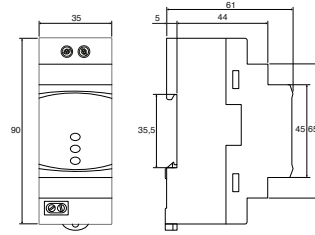

CEM-C21 / CEM-C31

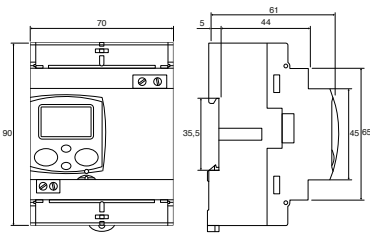

CEM-C21-485

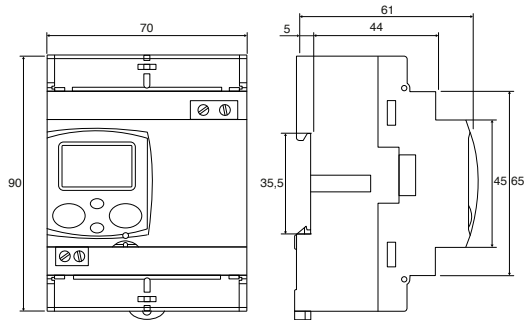

CEM-C31-485

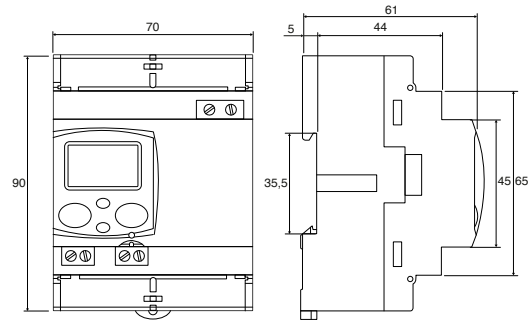

Protection and control

Residual current protection

RG1M, Residual current relays 1 module	90
RGE-R, Residual current relay, type A, for WGC transformer, 2 modules with visual prealarm.....	90
RGU-2, Programmable residual current relay, 2 modules with display and static prealarm output.....	90
RGU-10, Residual current relay, type A, for ultra-immunised WGC Transformer, 3 modules with display and programmable pre-alarm output.....	91
WGC, Residual current transformer	91
TP-WGC, Split-core residual current transformers.....	91
WRU10, Residual current relay, type A, with built-in transformer, ultra-immunised	92
WGBU, Transformer with built-in residual current relay, type A.....	92
RGU-10B, Residual current relay, type B.....	93
WGC-TB, Residual current transformers for type-B relays.....	93
RGU-100B, Residual current relay, type B.....	94
CBS-400B, 4 channels residual current relays, type B, 3 modules.....	94
WGB, Residual current transformers for type-B relays.....	94
WGB-35-TB, Relay Type B built-in residual current transformer.....	94
IDB-4, Type B RCCB.....	94
Residual current monitoring	
CBS-1600A, 16 channel differential current control unit type A.....	95
CBS-2000AB, 20 channel differential current control unit type A and B.....	95
WGC, Residual current transformer.....	95
WGB, Residual current transformers for type-B relays.....	95
Self-reclosing overcurrent and Residual current protection	

Overcurrent self-reclosing

Residual current protection and self-reclosing	
REC4 RCCB with self-reclosing system, type A.....	99
REC4-C RCCB with self-reclosing system, type A with status output.....	99
RECB RCCB with self-reclosing system, type B.....	99
RECB-C Reclosing RCCB with status output.....	99
Residual current protection and reclosing system	
WRU RM/RA Residual current relay with built-in transformer.....	101
RGU-10 RAL Reclosing protection relays and residual current reclosing with WGC external transformer	101
CBS4-RA Central protection and residual current reclosing with WGC external transformer.....	101
WGC Residual current transformer.....	101
TP-WGC Split-core residual current transformers.....	101
Overcurrent and residual current protection and reclosing	
RECmax-CVM Self-reclosing residual current relay with power analyzer functions, transformers included.....	103
RECmaxLPD Self-reclosing residual current relay with circuit breaker, used with a residual current transformer not included.....	103
RGU-10 MT Reclosing residual current relay for motorized circuit breakers	104
WRU-10-MT Residual current relay with built-in transformer.....	104
RECmaxMP MCB with reclosing (up to 63 A).....	104
MT-TS Motorised circuit-breaker.....	105
MT-TSD Motorised circuit-breaker suitable for residual current protection.....	105

Residual current protection for electric vehicles

IDA-EV, RCCB with 6 mADC supervision type A.....	107
Residual current protection and reclosing system for electric vehicles	
REC4-EV, RCCB with supervision and self-reclosing 6mADC, type A.....	108
REC4-EV-C, RCCB with supervision and reclosing 6mADC, type A.....	108
RECB-EV-C, RCCB with reclosing, type B.....	108

Relays and control elements

IMD-2R Offline insulation relay.....	109
WI Current detector relay.....	109

Protection current transformer

TRP, Protection transformers encapsulated in resin.....	110
---	-----

Measuring and testing equipments for substations

GETEST Step and contact voltage meter.....	112
OT2 Dielectric strenght tester.....	112
MH Microohmmeter.....	112
MD Digital Megaohmmeters.....	112
TL6 Earth resistance meter.....	112

Residual current protection

Selection table for Type A devices

	RG1M	RGE-R	WGBU	RGU-2	WRU-10	RGU-10A RGU-100A	CBS-40 CBS-400A
Installation type							
Single phase, three-phase, 3 and 4 wires	●	●	●	●	●	●	●
Features / performance							
Ultra-immunized system	●	●	●	●	●	●	●
Monitoring	-	-	-	●	●	●	●
Pre-alarm	-	●	●	●	●	●	●
Remote control	-	-	-	●	●	●	●
Technical characteristics							
Residual current type	A	A	A	A	A	A	A
Measurement channels	1	1	1	1	1	1	4
Constant current sensitivity	●	-	-	-	-	-	-
Adjustable current sensitivity	-	●	●	●	●	●	●
Fixed delay time	●	-	-	-	-	-	-
Adjustable delay time	-	●	●	●	●	●	●
Built-in current transformer	-	-	35...210	-	28	-	-
External current transformer, WGC Ø 20...500x200 mm	●	●	-	●	-	●	●
Trigger output	●	●	●	●	●	●	●
Pre-alarm output	-	●	-	●	●	●	●
Remote control input	-	-	●	●	●	●	●
RS-485 Communications	-	-	-	-	-	ST	ST
Module size	1	2	-	2	3	3	3

ST - According to type



RG1M, Residual current relays 1 module

Type	Code	IΔn (A)	N° relays	Delay	Power supply	Módulos	Mounting
RG1M - 0,03	[*] P12204.	0,03 A	1	0,02 s	230 Vac	1	DIN rail
RG1M - 0,3	[*] P12214.	0,3 A	1	0,02 s	230 Vac	1	DIN rail

Requires a WGC residual current transformer



RGE-R, Residual current relay, type A, for WGC transformer, 2 modules with visual prealarm.

Type	Code	IΔn (A)	N° relays	Delay	Power supply	Módulos	Mounting
RGE-RL	[*] P12A32.	0,03 ... 5 A	1	0,02 ... 5 s	230 Vac	2	DIN rail
RGE-R	[*] P122320040000	0,03 ... 5 A	1	0,02 ... 5 s	24...48 Vac 24...125 Vdc	2	DIN rail

Requires a WGC residual current transformer To encode other parameters, such as the auxiliary power supply voltage, see the table at the end of the section



RGU-2, Programmable residual current relay, 2 modules with display and static prealarm output

Type	Code	IΔn (A)	N° relays	Pre-alarm relay	Delay	Power supply	Módulos	Mounting
RGU2	[*] P11A61.	0,03 ... 5 A	1	●	0,1 ... 5 s, INS, SEL	120...230 Vac	2	DIN rail

Requires a WGC residual current transformer.

NEW

RGU-10, Residual current relay, type A, for ultra-immunised WGC Transformer, 3 modules with display and programmable pre-alarm output.

Type	Code	IΔn (A)	N° relays	Pre-alarm relay	Delay	Commu- nications	Protocol	Power supply	Módulos	Mounting
Possibility UL on demand										
RGU-10A	[*] P11A70.	0,03 ...30 A	2	●	0,1... 5 s, INS, SEL	-	-	110 ... 230 Vac	3	DIN rail
RGU-100A	[*] P11A71.	0,03 ...30 A	2	●	0,1... 5 s, INS, SEL	RS-485	Modbus/RTU	110 ... 230 Vac	3	DIN rail

For supply voltages other than 230 Vac, please consult us.

Type	Code	Description
Adap-Panel-D3M	[*] MSZZF10000E3	Panel adapter CVM-E3-MINI, RGU, CBS (72 x 72)

NEW

CBS-40A/400A, 4 channels residual current relays, type A, 3 modules with display and a configurable prealarm output.

Type	Code	IΔn (A)	N° relays	Pre-alarm relay	Delay	Commu- nications	Protocol	Power supply	Módulos	Mounting
CBS-40A	[*] P12A70.	0,03 ... 30 A	4	●	0,1 ... 5 s, INS, SEL	-	-	110 ... 230 V~	3	DIN rail
CBS-400A	[*] P12A71.	0,03 ... 30 A	4	●	0,1 ... 5 s, INS, SEL	RS-485	Modbus/RTU	110 ... 230 V~	3	DIN rail

For supply voltages other than 230 Vac, please consult us.

Associated Transformers



WGC, Residual current transformer

Type	Code	Usefull diam.(mm)	In (A)	Cable (m)	weight (kg)
WGC-20-SC	[*] P10181.	20	63	0,5	0,08
WGC-30-SC	[*] P10182.	30	63	0,5	0,09
WGS-20	[*] P10131.	20	63	-	0,06
WGS-30	[*] P10132.	30	63	-	0,07
WGC-25	[*] P10151.	25	63	-	0,08
WGC-35	[*] P10152.	35	80	-	0,11
WGC-55	[*] P10153.	55	160	-	0,17
WGC-80	[*] P10154.	80	250	-	0,29
WGC-110	[*] P10155.	115	400	-	0,41
WGC-140	[*] P10156.	140	600	-	0,68
WGC-180	[*] P10157.	180	800	-	0,91
WGC-220x105	[C] P10158.	220 x 105	1250	-	3,90
WGC-350x150	[C] P10159.	350 x 150	2000	-	6,80
WGC-500x200	[C] P10160.	500 x 200	4000	-	11,00

Type	Code	Description
PA-TC/WG	[*] P19921.	DIN rail mounting accessory for WGC-25, WGC-35 and WGC-55



TP-WGC, Split-core residual current transformers

Type	Code	Usefull diam.(mm)	IΔn (A)	IΔn min.(A)	In (A)	weight (kg)
TP58 WGC	[C] P11121.	80 x 50	acc. relay > 0,3A	0,3	80	0,80
TP88 WGC	[C] P11131.	80 x 80	acc. relay > 0,3A	0,3	125	1,05
TP812 WGC	[C] P11141.	120 x 80	acc. relay > 0,3A	0,3	250	1,06
TP816 WGC	[C] P11151.	160 x 80	acc. relay > 0,3A	0,3	400	2,45

Compatible with Type A relays



WRU10, Residual current relay, type A, with built-in transformer, ultra-immunised

Type	Code	Usefull diam.(mm)	IΔn (A)	N° relays	Pre-alarm relay	Delay	Nr. reclosures	Power supply	Módulos	Mounting
WRU-10	[*] P14035.	28	0,03 ... 30 A	1	●	0,02 ... 10 s, INS, SEL	-	230 Vac	3	DIN rail
WRU-10-HS	[C] P14036.	28	0,01 ... 0,5 A	1	●	0,02 ... 10 s, INS, SEL	30	230 Vac	3	DIN rail

To encode other parameters, such as the auxiliary power supply voltage, see the table at the end of the section.



WGBU, Transformer with built-in residual current relay, type A

Configurable residual current relay with visual pre-alarm. 230 Vac Auxiliary power supply

Type	Code	Usefull diam.(mm)	IΔn (A)	N° relays	Delay	Mounting
WGBU-35	[C] P16011.	35	0,03 ... 3 A	1	0,02...1 s	Panel background
WGBU-70	[C] P16012.	70	0,03 ... 3 A	1	0,02...1 s	Panel background
WGBU-105	[C] P16013.	105	0,03 ... 3 A	1	0,02...1 s	Panel background
WGBU-140	[C] P16014.	140	0,03 ... 3 A	1	0,02...1 s	Panel background
WGBU-210	[C] P16015.	210	0,03 ... 3 A	1	0,02...1 s	Panel background

Relay mounted at 90°. It allows to reduce the mounting space

WGBU-90-35	[C] P16021.	35	0,03 ... 3 A	1	0,02...1 s	Panel background
WGBU-90-70	[C] P16022.	70	0,03 ... 3 A	1	0,02...1 s	Panel background
WGBU-90-105	[C] P16023.	105	0,03 ... 3 A	1	0,02...1 s	Panel background
WGBU-90-140	[C] P16024.	140	0,03 ... 3 A	1	0,02...1 s	Panel background
WGBU-90-210	[C] P16025.	210	0,03 ... 3 A	1	0,02...1 s	Panel background

TABLE OF ADDITIONAL FEATURES

WRU-10											
P	1	X	X	X	X	0	0	X	Delivery time		
Code	Internal code						↑				
Power supply voltage	Standard (230 V _{ac})						0	-			
	110 V _{ac}						1	1			

Selection table for Type B devices

IDB-4 WGB-35-TB RGU-10B RGU-100B CBS-400B



Installation type					
Single phase, three-phase, 3 and 4 wires	●	●	●	●	●
Features / performance					
Monitoring	-	-	●	●	●
Pre-alarm	-	-	●	●	●
Remote control	-	●	●	●	●
Technical characteristics					
Residual current type	B	B	B	B	B
Measurement channels	1	1	1	1	4
Fixed current sensitivity	●	●	-	-	-
Adjustable current sensitivity	-	-	●	●	●
Fixed delay time	●	●	-	-	-
Adjustable delay time	-	-	●	●	●
Built-in current transformer	●	35	-	-	-
External current transformer, WGC-TB or WGB	-	-	WGC-TB	WGB	WGB
Trigger output	-	●	●	●	●
Pre-alarm output	-	-	●	●	●
Remote control input	-	-	●	●	●
Communications	-	-	-	●	●
Module size	4	-	3	3	3



RGU-10B, Residual current relay, type B

Programmable residual current relay, 3 modules with display and configurable pre-alarm output.

Type	Code	IΔn (A)	N° relays	Pre-alarm relay	Delay	Power supply	Módulos	Mounting
RGU-10B	[*] P11951.	0,1...3 A	1	●	0,1 ... 10 s	230 Vac	3	DIN rail

Requires an residual current transformer, WGC-TB type. See coding table for other options.

Type	Code	Description
ADP CVM-MINI/RGU10/CBS4	[*] M5ZZF1.	Panel adapter CVM MINI / RGU-10 / CBS-4 (72 x 72)



WGC-TB, Residual current transformers for type-B relays

Type	Code	Usefull diam.(mm)	IΔn min.(A)	In (A)	weight (kg)
WGS-20-TB	[*] P11731.	20	0.1	63	0,08
WGC-25-TB	[*] P11751.	25	0.1	63	0,12
WGC-35-TB	[*] P11752.	35	0.1	80	0,11
WGC-55-TB	[*] P11753.	55	0.3	160	0,18
WGC-80-TB	[*] P11755.	80	0.5	250	0,25
WGC-110 TB	[*] P11756.	110	0.5	400	0,38
WGC-140 TB	[*] P11757.	140	0.5	600	0,48
WGC-180 TB	[*] P11758.	180	0.5	800	0,20

Only for RGU-10B type relays

TABLE OF ADDITIONAL FEATURES

RGU-10B				
P	1	X	X	X
Code				
Power supply voltage	Standard (230 V _{ac})	0	1	4
	110 V _{ac}	1	1	1
	24...48 V _{ac} / 24...125 V _{dc}	4	1	1

Delivery time: [*] Immediate, [x] working weeks, [c] Consult



RGU-100B, Residual current relay, type B

Type	Code	I Δ n (A)	N° relays	Pre-alarm relay	Delay	Commu- nications	Protocol	Power supply	Módules	Mounting
RGU-100B	[*] P11961.	0,03 ... 3 A	1	●	0,1 ... 5 s, INS, SEL	RS-485	Modbus/RTU	230 Vac	3	DIN rail

Associated with WGB-type residual current transformers



CBS-400B, 4 channels residual current relays, type B, 3 modules

Type	Code	I Δ n (A)	N° relays	Pre-alarm relay	Delay	Commu- nications	Protocol	Power supply	Módules	Mounting
CBS-400B	[*] P12721.	0,03 ... 3 A	4	●	0,1 ... 5 s, INS, SEL	RS-485	Modbus/RTU	230 Vac	3	DIN rail

Associated with WGB-type residual current transformers



WGB, Residual current transformers for type-B relays

Type	Code	Usefull diam.(mm)	I Δ n (A)	In (A)	weight (kg)
WGB-35	[C] P11B52.	35.5	0.03 ... 3 A	80	0,22
WGB-55	[C] P11B53.	55.5	0.03 ... 3 A	160	0,33
WGB-80	[C] P11B54.	80.5	0.03 ... 3 A	250	0,53
WGB-110	[C] P11B55.	110.5	0.03 ... 3 A	400	0,69
WGB-140	[C] P11B56.	140.5	0.1 ... 3 A	630	0,80

Only for relays type RGU-100B and CBS-400B

Type	Code	Description
Adap-Panel-D3M	[*] M5ZZF100000E3	Panel adapter CVM-E3-MINI, RGU, CBS (72 x 72)



WGB-35-TB, Relay Type B built-in residual current transformer

Type	Code	Usefull diam.(mm)	N° relays	Delay	Sensitivity	weight (kg)
WGB-35-TB30	[C] P16111.	35	1	INS	30 mA	0,25
WGB-35-TB300	[C] P16121.	35	1	INS	300 mA	0,27
WGB-35-TB300S	[C] P16131.	35	1	SEL	300 mA	0,25



IDB-4, Type B RCCB

Type	Code	In (A)	Poles	Sensitivity	Mounting
IDB-4 4P-40A-30 mA	[*] P17221.	40 A	4	30 mA	DIN rail
IDB-4 4P-40A-300 mA	[*] P17222.	40 A	4	300 mA	DIN rail
IDB-4 4P-63A -30 mA	[*] P17231.	63 A	4	30 mA	DIN rail
IDB-4 4P-63A -300mA	[*] P17232.	63 A	4	300 mA	DIN rail

For three-phase and single-phase networks

Residual current monitoring

	CBS-2000-AB	CBS-1600-A
Installation type and features		
	●	●
	●	●
	●	●
	●	-
	16	16
	4	-
	0,03 a 3 A	0,03 a 3 A
	0,03 a 3 A	-
	1	1
	1	1
	0,1 a 5 s	0,1 a 5 s
	0,1 a 5 s	-
	WGC	WGC
	WGB	-
	Si	Si
	6	6

NEW



CBS-1600A, 16 channel differential current control unit type A

Type	Code	IΔn (A)	N° relays	Pre-alarm relay	N° Input channels	Communi-cations	Power supply	Módulos	Mounting
CBS-1600A	[*] P12B01.	0,03...3 A	2	●	16 (A)	RS-485	230 V ~ (± 15%)	6	DIN rail

Associated with WGC-type residual current transformers

NEW



CBS-2000AB, 20 channel differential current control unit type A and B

Type	Code	IΔn (A)	N° relays	Pre-alarm relay	N° Input channels	Communi-cations	Power supply	Módulos	Mounting
CBS-2000AB	[*] P12B02.	0,03...3 A	2	●	16 (A) / 4 (B)	RS-485	230 V ~ (± 15%)	6	DIN rail

Associated with type WGC-type residual current transformers for type A channels and WGB-type for type B channels.



WGC, Residual current transformer

Type	Code	Usefull diam.(mm)	In (A)	Cable (m)	weight (kg)
WGC-20-SC	[*] P10181.	20	63	0,5	0,08
WGC-30-SC	[*] P10182.	30	63	0,5	0,09
WGS-20	[*] P10131.	20	63	-	0,06
WGS-30	[*] P10132.	30	63	-	0,07
WGC-25	[*] P10151.	25	63	-	0,08
WGC-35	[*] P10152.	35	80	-	0,11
WGC-55	[*] P10153.	55	160	-	0,17
WGC-80	[*] P10154.	80	250	-	0,29
WGC-110	[*] P10155.	115	400	-	0,41
WGC-140	[*] P10156.	140	600	-	0,68
WGC-180	[*] P10157.	180	800	-	0,91
WGC-220x105	[C] P10158.	220 x 105	1250	-	3,90
WGC-350x150	[C] P10159.	350 x 150	2000	-	6,80
WGC-500x200	[C] P10160.	500 x 200	4000	-	11,00



WGB, Residual current transformers for type-B relays

Type	Code	Usefull diam.(mm)	IΔn (A)	In (A)	weight (kg)
WGB-35	[C] P11B52.	35.5	0.03 ... 3 A	80	0,22
WGB-55	[C] P11B53.	55.5	0.03 ... 3 A	160	0,33
WGB-80	[C] P11B54.	80.5	0.03 ... 3 A	250	0,53
WGB-110	[C] P11B55.	110.5	0.03 ... 3 A	400	0,69
WGB-140	[C] P11B56.	110.5	0.03 ... 3 A	400	-

Only for relays type RGU-100B and CBS-400B

Delivery time: [*] Immediate, [x] working weeks, [c] Consult

Dimensions

RG1M

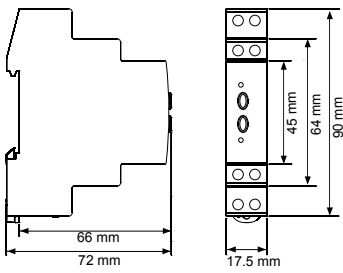

RGE

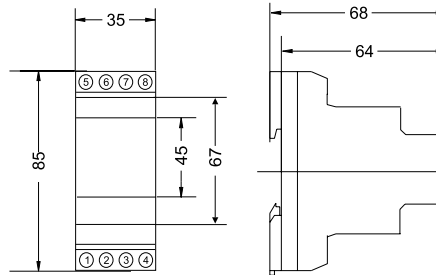

RGU-10B

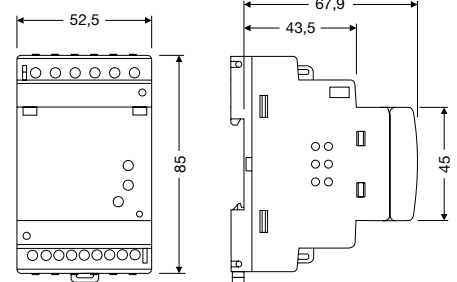

RGU-2

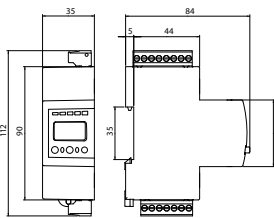

IDB-4

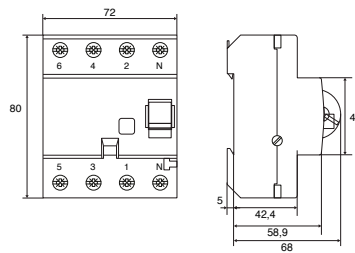

WRU-10

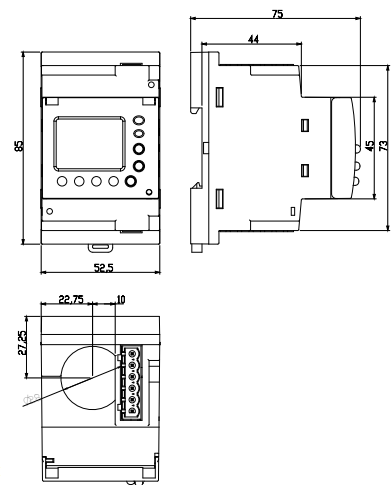

WGB-35-TB

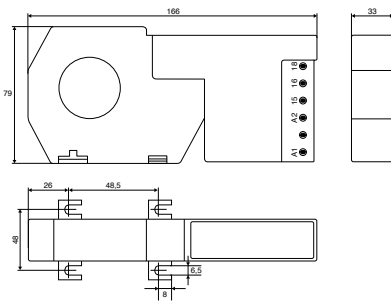

TP-WGC

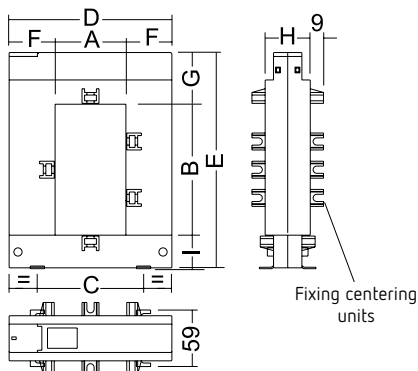

Dimensions (mm)	TP-58	TP-88	TP-812	TP-816
a	50	80	80	80
b	80	80	120	160
c	78	108	108	120
d	114	144	144	184
e	145	145	185	245
f	32	32	32	52
g	32	32	32	47
h	32	32	32	52
i	32	32	32	38

WGC / WGC-TB

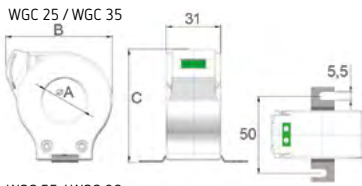

WGC 55 / WGC 80
WGC 110 / WGC 140

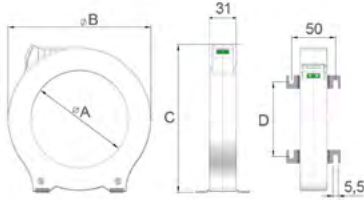

Modelo	A	B	C	D
WGC 25	25	60,5	64	
WGC 35	35	70,5	75,5	
WGC 55	55	92	98	38
WGC 80	80	124,5	130	60
WGC 110	110	163	168	84,5
WGC 140	140	201	206	110
WGC 180	180	252	256	144

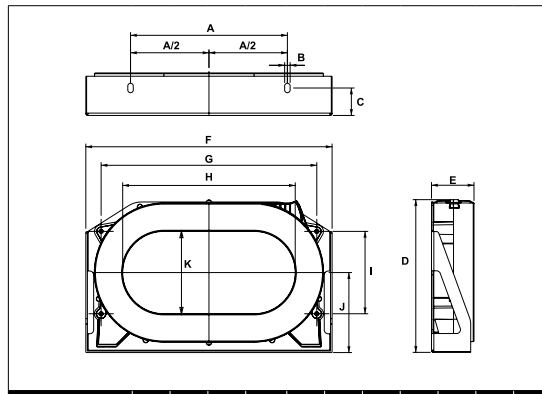

	A	B	C	D	E	F	G	H	I	J	K
WGC 220x105	200	7	35	195	54,2	314	275	220	105	102	105
WGC 350x150	340	7	30	279	50,2	479	430	350	165	143	150
WGC 500x200	460	7	40	306	64	614	550	500	180	155	200

WGS

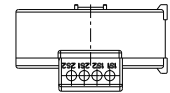
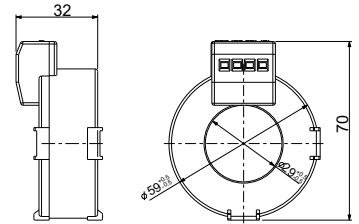
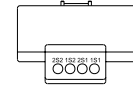
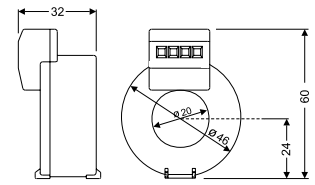

WGBU

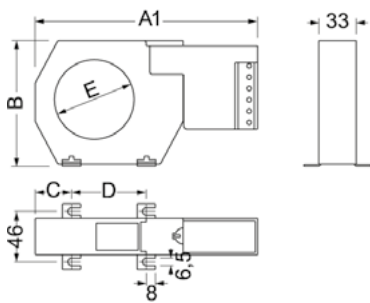

WGBU-90

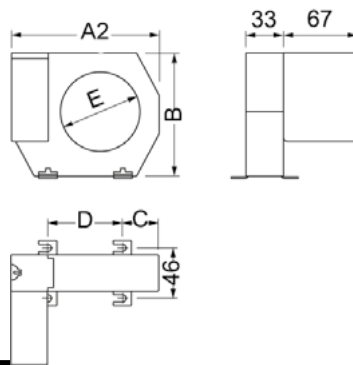





Type	A1	A2	B	C	D	E
WGBU-35 (A1) / WGBU-90-35 (A2)	166	100	79	26	48,5	35
WGBU-70 (A1) / WGBU-90-70 (A2)	196	130	110	332	66	70
WGBU-105 (A1) / WGBU-90-105 (A2)	236	170	146	38	94	105
WGBU-140 (A1) / WGBU-90-140 (A2)	286	220	196	48,5	123	140
WGBU-210 (A1) / WGBU-90-210 (A2)	365	299	284	69	161	210

Self-reclosing overcurrent and Residual current protection

Table of residual current device and circuit breaker devices with automatic reclosing system

RCCBs	REC4, REC4-C, RECB, RECB-C
Residual current relays	WRU-10 RAL, RGU-10 RAL, CBS4-RA
Residual current and circuit breaker protection	RGU-10MT, RECMaXLPD, RECMaXCVM,
Overcurrent self-reclosing	RECMaXP

Selection table RCCBs

	REC4	REC4-C	RECB	RECB-C
				
Protection type				
Residual current	●	●	●	●
Reclosure type				
Residual current	●	●	●	●
Installation type				
Single phase, three-phase, 3 and 4 wires	●	●	●	●
Circuit breaker				
Switch (included)	●	●	●	●
Features / performance				
Status indication	–	●	–	●
Insulation monitoring	●	●	–	–
Technical specifications				
Residual current type	A	A	B	B
Fixed current sensitivity	●	●	●	●
Fixed delay time	●	●	●	●
Built-in current transformer	●	●	●	●
Output status	–	–	–	●
Self-reclosing	●	●	●	●
Module size	"3 (2P) 5 (4P)"	"3 (2P) 5 (4P)"	5 (4P)"	5 (4P)"

Residual current protection and self-reclosing

**REC4** RCCB with self-reclosing system, type A

Type	Code	N° relays	Breaking element	In (A)	Poles	Sensitivity	Reclosing mode	Módulos
REC4-2P-40-30	[*] P26A21.	1	built-in	40 A	2	30 mA	Insulation	3
REC4-2P-40-300	[C] P26A23.	1	built-in	40 A	2	300 mA	Time	3
REC4-2P-63-30	[C] P26A31.	1	built-in	63 A	2	30 mA	Insulation	3
REC4-2P-63-300	[C] P26A33.	1	built-in	63 A	2	300 mA	Time	3
REC4-4P-40-30	[C] P26F21.	1	built-in	40 A	4	30 mA	Time	5
REC4-4P-40-300	[C] P26F23.	1	built-in	40 A	4	300 mA	Time	5
REC4-4P-63-30	[C] P26F31.	1	built-in	63 A	4	30 mA	Time	5
REC4-4P-63-300	[C] P26F33.	1	built-in	63 A	4	300 mA	Time	5

3 reconnections: 3, 20, 180 s.

**REC4-C** RCCB with self-reclosing system, type A with status output

Type	Code	N° relays	Breaking element	In (A)	Poles	Sensitivity	Reclosing mode	Módulos
REC4-C 2P 40 30	[C] P27A21.	1	built-in	40 A	2	30 mA	Time	3
REC4-C 2P 40 300	[C] P27A31.	1	built-in	40 A	2	300 mA	Time	3
REC4-C 2P 63 30	[C] P27A23.	1	built-in	63 A	2	30 mA	Time	3
REC4-C 2P 63 300	[C] P27A33.	1	built-in	63 A	2	300 mA	Time	3
REC4-C 4P 40 30	[C] P27F21.	1	built-in	40 A	4	30 mA	Time	5
REC4-C 4P 40 300	[C] P27F31.	1	built-in	40 A	4	300 mA	Time	5
REC4-C 4P 63 30	[C] P27F23.	1	built-in	63 A	4	30 mA	Time	5
REC4-C 4P 63 300	[C] P27F33.	1	built-in	63 A	4	300 mA	Time	5

3 reconnections: 3, 20, 180 s. Consult reference for different modes of operation of the status output.

**RECB** RCCB with self-reclosing system, type B

Type	Code	N° relays	Breaking element	In (A)	Poles	Sensitivity	Reclosing mode	Módulos
RECB-4P-40-30	[C] P26G21.	1	built-in	40 A	4	30 mA	Time	5
RECB-4P-40-300	[C] P26G23.	1	built-in	40 A	4	300 mA	Time	5
RECB-4P-63-30	[C] P26G31.	1	built-in	63 A	4	30 mA	Time	5
RECB-4P-63-300	[C] P26G33.	1	built-in	63 A	4	300 mA	Time	5

3 reconnections: 3, 20, 180 s.

**RECB-C** Reclosing RCCB with status output

12 VAC auxiliary power supply

Type	Code	N° relays	Breaking element	In (A)	Poles	Sensitivity	Reclosing mode
RECB-C-4P-40-300	[C] P26M01.	1	built-in	40 A	4	300 mA	remote control
RECB-C-4P-63-300	[C] P26M11.	1	built-in	63 A	4	300 mA	remote control

(*) Not included in the reference

Delivery time: [*] Immediate, [x] working weeks, [c] Consult

Circuitor. The Future is Efficiency

Residual current protection and reclosing system

Selection table residual current relays

Residual current and circuit breaker protection

WRU-10 RAL



RGU-10 RAL



CBS4-RA



	WRU-10 RAL	RGU-10 RAL	CBS4-RA
Protection type			
Residual current	●	●	●
Reclosure type			
Residual current	●	●	●
Installation type			
Single phase, three-phase, 3 and 4 wires	●	●	●
Circuit breaker			
Contact (not included)	●	●	●
Features / performance			
Monitoring	●	●	●
Pre-alarm	●	●	
Remote control	●	●	●
Technical specifications			
Residual current type	A	A	A
Circuit breaker: contact	●	●	●
Measurement channels	1	1	4
Adjustable current sensitivity	●	●	●
Adjustable delay time	●	●	●
Built-in current transformer (Ø mm)	28 mm	–	–
External current transformer, WGC Ø 20...500x200	–	●	●
Trigger output	●	●	●
Pre-alarm output	●	●	–
Remote control input	●	●	●
Adjustable reclosing time	●	●	●
Communications	–	ST	ST
Module size	3	3	3

ST - Depending on type



WRU RM/RA Residual current relay with built-in transformer

Type	Code	Usefull diam. (mm)	I Δ n (A)	N° relays	Breaking element	Delay	Nr. reclosures	Time between reclosures
WRU-10-RAL	[*] P24453.	28	0,03 ... 3 A 0,03 ... 30 A	1	Contactor	0,02...10 s, INS, SEL	Programmable	Programmable
WRU-10-RAL0,3-1	[*] P24457.	28	0,3 ... 1 A	1	Contactor	0,02 INS	Programmable	Programmable

Requires an residual current transformer, WGC type (not included). The breaking element to be associated must be a contactor not included. To encode other parameters, see the table at the end of the section.

RGU-10 RAL Reclosing protection relays and residual current reclosing with WGC external transformer



Type A ultra-immunised residual current relay, programmable, 3 modules with display and locking status release by reclosing. 230 Vac auxiliary power supply.

Type	Code	I Δ n (A)	N° relays	Breaking element	Delay	Communications	Nr. reclosures
RGU-10 RAL	[*] P24622.	0,03 ... 30 A	1	Contactor	0,02...10 s, INS, SEL	-	Programmable
RGU-10C RAL	[*] P24662.	0,03 ... 30 A	1	Contactor	0,02...10 s, INS, SEL	RS-485	Programmable

Requires an residual current transformer, WGC type (not included). The breaking element to be associated must be a contactor not included.

To encode other parameters, see the table at the end of the section.



CBS4-RA Central protection and residual current reclosing with WGC external transformer

Station with 4 Type A ultra-immunised residual current relays, programmable, 4 modules with display and locking status release by reclosing. 230 Vac Auxiliary power supply.

Type	Code	I Δ n (A)	N° relays	Breaking element	Delay	Communications	Nr. reclosures
CBS-4 RA	[*] P24911.	0,03 ... 30 A	4	Contactor	0,02...10 s, INS, SEL	-	Programmable
CBS-4C-RA	[*] P24912.	0,03 ... 30 A	4	Contactor	0,02...10 s, INS, SEL	RS-485	Programmable

Requires an residual current transformer, WGC type (not included). The breaking element to be associated must be a contactor not included.

To encode other parameters, see the table at the end of the section



WGC Residual current transformer

Type	Code	Usefull diam.(mm)	In (A)	Cable (m)	weight (kg)
WGC-20-SC	[*] P10181.	20	63	0,5	0,08
WGC-30-SC	[*] P10182.	30	63	0,5	0,09
WGS-20	[*] P10131.	20	63	-	0,06
WGS-30	[*] P10132.	30	63	-	0,07
WGC-25	[*] P10151.	25	63	-	0,08
WGC-35	[*] P10152.	35	80	-	0,11
WGC-55	[*] P10153.	55	160	-	0,17
WGC-80	[*] P10154.	80	250	-	0,29
WGC-110	[*] P10155.	115	400	-	0,41
WGC-140	[*] P10156.	140	600	-	0,68
WGC-180	[*] P10157.	180	800	-	0,91
WGC-220x105	[C] P10158.	220 x 105	1250	-	3,90
WGC-350x150	[C] P10159.	350 x 150	2000	-	6,80
WGC-500x200	[C] P10160.	500 x 200	4000	-	11,00



TP-WGC Split-core residual current transformers

Type	Code	Usefull diam.(mm)	I Δ n (A)	I Δ n min.(A)	In (A)	weight (kg)
TP58 WGC	[C] P11121.	80 x 50	acc. relay > 0,3A	0,3	80	0,80
TP88 WGC	[C] P11131.	80 x 80	acc. relay > 0,3A	0,3	125	1,05
TP812 WGC	[C] P11141.	120 x 80	acc. relay > 0,3A	0,3	250	1,06
TP816 WGC	[C] P11151.	160 x 80	acc. relay > 0,3A	0,3	400	2,45

Compatible with Type A relays

Residual current and circuit breaker protection

Selection table residual current and circuit breaker protection

Residual current protection and reclosure control	WRU-10MT	RGU-10MT	RECMaXLPD	RECMaXCVM	RECMaXMP
					
Circuit breaker protection	RECMaXMP MT-TSD	RECMaXMP MT-TSD			
Protection type					
Residual current	●	●	●	●	–
Circuit breaker	●	●	●	●	●
Reclosure type					
Residual current	●	●	●	●	–
Circuit breaker	●	●	●	●	●
Installation type					
Single phase, three-phase, 3 and 4 wires	●	●	●	●	●
Circuit breaker					
Switch (included)	●	●	●	●	●
Features / performance					
Monitoring	●	●	●	●	–
Remote control	●	●	●	●	●
Power analyzer	–	–	–	●	–
Technical specifications					
Residual current type	A	A	A	A	–
Adjustable current sensitivity	●	●	●	●	–
Adjustable delay time	●	●	●	●	–
Built-in current transformer	28 mm	–	–	–	–
External current transformer, WGC Ø 20...500x200 mm	–	●	●	●	–
Digital output	–	–	–	●	–
Reclosing end output	●	●	●	●	●
Switch status output	●	●	●	●	●
Alarm output	●	●	●	●	●
Reclosing blocked output	–	–	–	●	–
Remote control input	●	●	●	●	●
Self-reclosing	–	–	–	–	●
Adjustable reclosing time	●	●	●	●	–
Communications	–	ST	–	–	–
Module size	7,5 (2P) 9,5 (4P)	7,5 (2P) 9,5 (4P)	4,5 (2P) 6,5 (4P)	4,5 (2P) 6,5 (4P)	7,5 (2P) 9,5 (4P)

Overcurrent and residual current protection and reclosing



RECmax-CVM Self-reclosing residual current relay with power analyzer functions, transformers included

Type	Code	In (A)	Commu- nications	Poles	Módulos
2 Poles, C Curve					
RECmax-CVM 2P C2-10	[2] P2B111.	10 A	RS-485	2	5.5
RECmax-CVM 2P C2-16	[2] P2B112.	16 A	RS-485	2	5.5
RECmax-CVM 2P C2-20	[2] P2B113.	20 A	RS-485	2	5.5
RECmax-CVM 2P C2-25	[2] P2B114.	25 A	RS-485	2	5.5
RECmax-CVM 2P C2-32	[2] P2B115.	32 A	RS-485	2	5.5
RECmax-CVM 2P C2-40	[2] P2B116.	40 A	RS-485	2	5.5
RECmax-CVM 2P C2-50	[2] P2B117.	50 A	RS-485	2	5.5
RECmax-CVM 2P C2-63	[2] P2B118.	63 A	RS-485	2	5.5
4 Poles, C Curve					
RECmax-CVM 4P C4-10	[2] P2B121.	10 A	RS-485	4	7.5
RECmax-CVM 4P C4-16	[2] P2B122.	16 A	RS-485	4	7.5
RECmax-CVM 4P C4-20	[2] P2B123.	20 A	RS-485	4	7.5
RECmax-CVM 4P C4-25	[2] P2B124.	25 A	RS-485	4	7.5
RECmax-CVM 4P C4-32	[2] P2B125.	32 A	RS-485	4	7.5
RECmax-CVM 4P C4-40	[2] P2B126.	40 A	RS-485	4	7.5
RECmax-CVM 4P C4-50	[2] P2B127.	50 A	RS-485	4	7.5
RECmax-CVM 4P C4-63	[2] P2B128.	63 A	RS-485	4	7.5

Type	Code	In (A)	Commu- nications	Poles	Módulos
2 Poles, D Curve					
RECmax-CVM 2P D2-10	[2] P2B131.	10 A	RS-485	2	5.5
RECmax-CVM 2P D2-16	[2] P2B132.	16 A	RS-485	2	5.5
RECmax-CVM 2P D2-20	[2] P2B133.	20 A	RS-485	2	5.5
RECmax-CVM 2P D2-25	[2] P2B134.	25 A	RS-485	2	5.5
RECmax-CVM 2P D2-32	[2] P2B135.	32 A	RS-485	2	5.5
RECmax-CVM 2P D2-40	[2] P2B136.	40 A	RS-485	2	5.5
RECmax-CVM 2P D2-50	[2] P2B137.	50 A	RS-485	2	5.5
RECmax-CVM 2P D2-63	[2] P2B138.	63 A	RS-485	2	5.5
4 Poles, D Curve					
RECmax-CVM 4P D4-10	[2] P2B141.	10 A	RS-485	4	7.5
RECmax-CVM 4P D4-16	[2] P2B142.	16 A	RS-485	4	7.5
RECmax-CVM 4P D4-20	[2] P2B143.	20 A	RS-485	4	7.5
RECmax-CVM 4P D4-25	[2] P2B144.	25 A	RS-485	4	7.5
RECmax-CVM 4P D4-32	[2] P2B145.	32 A	RS-485	4	7.5
RECmax-CVM 4P D4-40	[2] P2B146.	40 A	RS-485	4	7.5
RECmax-CVM 4P D4-50	[2] P2B147.	50 A	RS-485	4	7.5
RECmax-CVM 4P D4-63	[2] P2B148.	63 A	RS-485	4	7.5

All models feature the WGC20/30-SC residual current transformer and MC-3 or MC-1 measuring transformer with connected terminal. C/D curve circuit breaker with 6 kA cut off power (IEC 60898).



RECmaxLPD Self-reclosing residual current relay with circuit breaker, used with a residual current transformer not included

Type	Code	In (A)	Poles	Módulos
2 Poles, C Curve				
RECmaxLPd-C2-6	[1] P2A110.	6 A	2	4.5
RECmaxLPd-C2-10	[1] P2A111.	10 A	2	4.5
RECmaxLPd-C2-16	[1] P2A112.	16 A	2	4.5
RECmaxLPd-C2-20	[1] P2A113.	20 A	2	4.5
RECmaxLPd-C2-25	[1] P2A114.	25 A	2	4.5
RECmaxLPd-C2-32	[1] P2A115.	32 A	2	4.5
RECmaxLPd-C2-40	[1] P2A116.	40 A	2	4.5
RECmaxLPd-C2-50	[1] P2A117.	50 A	2	4.5
RECmaxLPd-C2-63	[1] P2A118.	63 A	2	4.5
4 Poles, C Curve				
RECmaxLPd-C4-6	[1] P2A120.	6 A	4	6.5
RECmaxLPd-C4-10	[1] P2A121.	10 A	4	6.5
RECmaxLPd-C4-16	[1] P2A122.	16 A	4	6.5
RECmaxLPd-C4-20	[1] P2A123.	20 A	4	6.5
RECmaxLPd-C4-25	[1] P2A124.	25 A	4	6.5
RECmaxLPd-C4-32	[1] P2A125.	32 A	4	6.5
RECmaxLPd-C4-40	[1] P2A126.	40 A	4	6.5
RECmaxLPd-C4-50	[1] P2A127.	50 A	4	6.5
RECmaxLPd-C4-63	[1] P2A128.	63 A	4	6.5

Type	Code	In (A)	Poles	Módulos
2 Poles, D Curve				
RECmaxLPd-D2-6	[1] P2A130.	6 A	2	5.3
RECmaxLPd-D2-10	[1] P2A131.	10 A	2	4.5
RECmaxLPd-D2-16	[1] P2A132.	16 A	2	4.5
RECmaxLPd-D2-20	[1] P2A133.	20 A	2	4.5
RECmaxLPd-D2-25	[1] P2A134.	25 A	2	4.5
RECmaxLPd-D2-32	[1] P2A135.	32 A	2	4.5
RECmaxLPd-D2-40	[1] P2A136.	40 A	2	4.5
RECmaxLPd-D2-50	[1] P2A137.	50 A	2	4.5
RECmaxLPd-D2-63	[1] P2A138.	63 A	2	4.5
4 Poles, D Curve				
RECmaxLPd-D4-6	[1] P2A140.	6 A	4	6.5
RECmaxLPd-D4-10	[1] P2A141.	10 A	4	6.5
RECmaxLPd-D4-16	[1] P2A142.	16 A	4	6.5
RECmaxLPd-D4-20	[1] P2A143.	20 A	4	6.5
RECmaxLPd-D4-25	[1] P2A144.	25 A	4	6.5
RECmaxLPd-D4-32	[1] P2A145.	32 A	4	6.5
RECmaxLPd-D4-40	[1] P2A146.	40 A	4	6.5
RECmaxLPd-D4-50	[1] P2A147.	50 A	4	6.5
RECmaxLPd-D4-63	[1] P2A148.	63 A	4	6.5

WGS-20/30 and WGC-25/35 residual current transformers. C/D curve circuit breaker with 6 kA cut off power (IEC 60898).



RGU-10 MT Reclosing residual current relay for motorized circuit breakers

Type	Code	IΔn (A)	Breaking element	Delay	Communications	Nr. reclosures	Time between reclosures
RGU-10 MT	[*] P24642.	0,03 ... 30 A	RECmaxMP MT-TSD	0,02...10 s, INS, SEL	-	Programmable	Programmable
RGU-10C MT	[*] P24652.	0,03 ... 30 A	RECmaxMP MT-TSD	0,02...10 s, INS, SEL	RS-485	Programmable	Programmable

The delay is cancelled in all relays with a sensitivity adjustment of 0.03 A, IEC 60947-2, annex M INS, SEL trip curves, according to IEC 61008-1, for trigger coils with a trip time <0.02 s
Requires a WGS/WGC residual current transformer (not included).
To operate with RECmax MP (in<63 A), with MT-TSD (in>63 A)



WRU-10-MT Residual current relay with built-in transformer

Type	Code	Usefull diam.(mm)	IΔn (A)	Delay	Nr. reclosures	Time between reclosures
WRU-10-MT	[C] P24275.	28	0,03 ... 30 A	0,02...10 s, INS, SEL	Programmable	Programmable

To operate with RECmax MP (In ≤ 63 A), with MT-TSD (In > 63 A).



RECmaxMP MCB with reclosing (up to 63 A)

Type	Code	In (A)	Poles	Módulos	Type	Code	In (A)	Poles	Módulos
2 Poles, C Curve					2 Poles, D Curve				
RECmax MP-C2-6	[1] P27110.	6 A	2	4.5	RECmax MP-D2-6	[1] P27130.	6 A	2	4.5
RECmax MP-C2-10	[1] P27111.	10 A	2	4.5	RECmax MP-D2-10	[1] P27131.	10 A	2	4.5
RECmax MP-C2-16	[1] P27112.	16 A	2	4.5	RECmax MP-D2-16	[1] P27132.	16 A	2	4.5
RECmax MP-C2-20	[1] P27113.	20 A	2	4.5	RECmax MP-D2-20	[1] P27133.	20 A	2	4.5
RECmax MP-C2-25	[1] P27114.	25 A	2	4.5	RECmax MP-D2-25	[1] P27134.	25 A	2	4.5
RECmax MP-C2-32	[1] P27115.	32 A	2	4.5	RECmax MP-D2-32	[1] P27135.	32 A	2	4.5
RECmax MP-C2-40	[1] P27116.	40 A	2	4.5	RECmax MP-D2-40	[1] P27136.	40 A	2	4.5
RECmax MP-C2-50	[1] P27117.	50 A	2	4.5	RECmax MP-D2-50	[1] P27137.	50 A	2	4.5
RECmax MP-C2-63	[1] P27118.	63 A	2	4.5	RECmax MP-D2-63	[1] P27138.	63 A	2	4.5
4 Poles, C Curve					4 Poles, D Curve				
RECmax MP-C4-6	[1] P27120.	6 A	4	6.5	RECmax MP-D4-6	[1] P27140.	6 A	4	6.5
RECmax MP-C4-10	[1] P27121.	10 A	4	6.5	RECmax MP-D4-10	[1] P27141.	10 A	4	6.5
RECmax MP-C4-16	[1] P27122.	16 A	4	6.5	RECmax MP-D4-16	[1] P27142.	16 A	4	6.5
RECmax MP-C4-20	[1] P27123.	20 A	4	6.5	RECmax MP-D4-20	[1] P27143.	20 A	4	6.5
RECmax MP-C4-25	[1] P27124.	25 A	4	6.5	RECmax MP-D4-25	[1] P27144.	25 A	4	6.5
RECmax MP-C4-32	[1] P27125.	32 A	4	6.5	RECmax MP-D4-32	[1] P27145.	32 A	4	6.5
RECmax MP-C4-40	[1] P27126.	40 A	4	6.5	RECmax MP-D4-40	[1] P27146.	40 A	4	6.5
RECmax MP-C4-50	[1] P27127.	50 A	4	6.5	RECmax MP-D4-50	[1] P27147.	50 A	4	6.5
RECmax MP-C4-63	[1] P27128.	63 A	4	6.5	RECmax MP-D4-63	[1] P27148.	63 A	4	6.5

C/D curve circuit breakers with 6 kA cut off power (IEC 60898).

TABLE OF ADDITIONAL FEATURES

RGU-10/C RAL / RGU-10C MT

P	2	X	X	X	X	0	0	X	X	X	X	X
Code	Internal code							↑	↑	↑	Delivery time	
Power supply voltage	Standard (230 V _{AC})							0			-	
	110 V _{AC} (WRU-10 RAL / MT)							1			2	
	24...48 V _{AC} / 24...125 V _{DC} (RGU-10/C RAL RGU-10/C MT)							4			1	
Certificate UL (Only RGU-10C MT 230 V _{AC})										0 7	2	



MT-TS Motorised circuit-breaker

Type	Code	In (A)	Poles
3 poles			
MT-TS- 80A- 3P	[1] P20H60.	80 A	3
MT-TS- 100A- 3P	[1] P20H61.	100 A	3
MT-TS- 125A- 3P	[1] P20H62.	125 A	3
MT-TS- 160A- 3P	[1] P20H63.	160 A	3
MT-TS- 250A- 3P	[1] P20H64.	250 A	3
MT-TS- 400A- 3P	[1] P20H65.	400 A	3
MT-TS- 630A- 3P	[1] P20H66.	630 A	3

Type	Code	In (A)	Poles
4 poles			
MT-TS- 80A- 4P	[1] P20H70.	80 A	4
MT-TS- 100A- 4P	[1] P20H71.	100 A	4
MT-TS- 125A- 4P	[1] P20H72.	125 A	4
MT-TS- 160A- 4P	[1] P20H73.	160 A	4
MT-TS- 250A- 4P	[1] P20H74.	250 A	4
MT-TS- 400A- 4P	[1] P20H75.	400 A	4
MT-TS- 630A- 4P	[1] P20H76.	630 A	4

Fixed magnetic and adjustable thermal protection



MT-TSD Motorised circuit-breaker suitable for residual current protection

Type	Code	In (A)	Poles
3 poles			
MT-TSD- 80A- 3P	[1] P20K60.	80 A	3
MT-TSD- 100A- 3P	[1] P20K61.	100 A	3
MT-TSD- 125A- 3P	[1] P20K62.	125 A	3
MT-TSD- 160A- 3P	[1] P20K63.	160 A	3
MT-TSD- 250A- 3P	[1] P20K64.	250 A	3
MT-TSD- 400A- 3P	[1] P20K65.	400 A	3
MT-TSD- 630A- 3P	[1] P20K66.	630 A	3

Type	Code	In (A)	Poles
4 poles			
MT-TSD- 80A- 4P	[1] P20K70.	80 A	4
MT-TSD- 100A- 4P	[1] P20K71.	100 A	4
MT-TSD- 125A- 4P	[1] P20K72.	125 A	4
MT-TSD- 160A- 4P	[1] P20K73.	160 A	4
MT-TSD- 250A- 4P	[1] P20K74.	250 A	4
MT-TSD- 400A- 4P	[1] P20K75.	400 A	4
MT-TSD- 630A- 4P	[1] P20K76.	630 A	4

Fixed magnetic and adjustable thermal protection

Dimensiones

REC4 2P 30

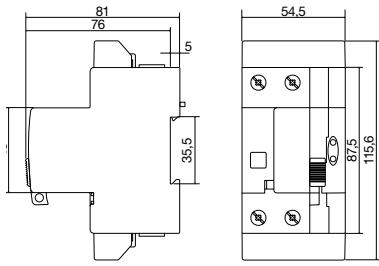

REC4 2P 300

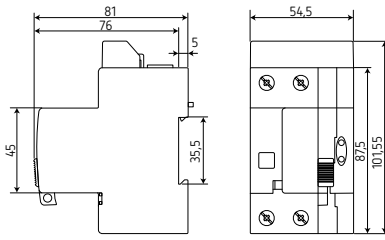

REC4 4P / RECB

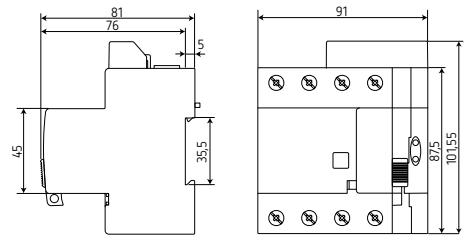

RECB-C

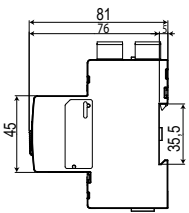

RGU-10 / CBS-4

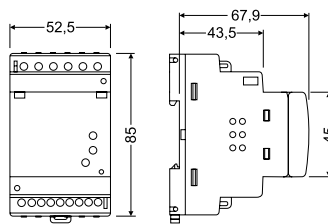

**RECmax
2 poles**

4 poles

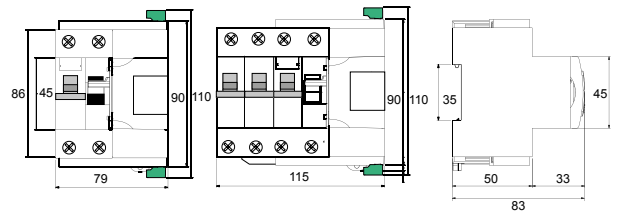

WRU-10

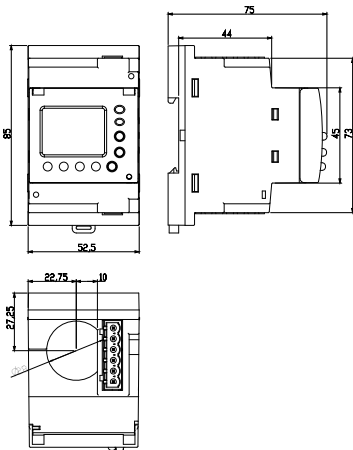

RECmax CVM

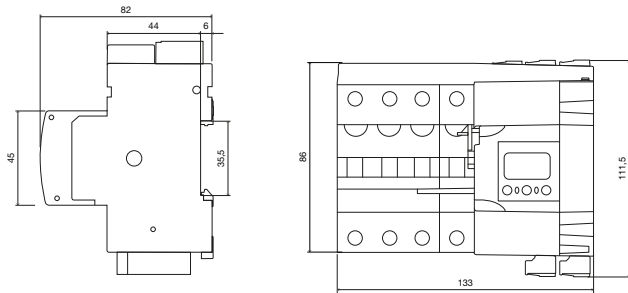

Residual current protection for electric vehicles

Selection table RCCBs

	IDA-EV	REC4-EV	REC4-EV-C	RECB-EV-C
				
Protection type				
Residual current	●	●	●	●
Installation type				
Single phase, three-phase, 3 and 4 wires	●	●	●	●
Circuit breaker				
Switch (included)	●	●	●	●
Features / performance				
Status LEDs	-	●	●	●
Switch status output	-	-	●	●
Remote reclosing input	-	-	●	●
Remote trigger input	-	-	●	●
Technical specifications				
Earth leakage type	A + 6 mAdc	A + 6 mAdc	A + 6 mAdc	B
Self-powered	●	●	-	-
Auxiliary power supply	-	-	●	●
Constant current sensitivity	●	●	●	●
Fixed delay time	●	●	●	●
Built-in current transformer	●	●	●	●
Self-reclosing	-	●	-	-
Remote control	-	-	●	●
Module size	4	5	5	5

Residual current protection for electric vehicles



IDA-EV, RCCB with 6 mADC supervision type A

Type	Code	In (A)	Poles	Sensitivity	Mounting
IDA-EV-40-30	[*] P17321.	40 A	4	30 mA + 6 mAdc	DIN rail
IDA-EV-63-30	[*] P17322.	63 A	4	30 mA + 6 mAdc	DIN rail



Residual current protection and reclosing system for electric vehicles



REC4-EV, RCCB with supervision and self-reclosing 6mADC, type A

Type	Code	In (A)	Poles	Sensitivity	Reclosing mode	Módulos
REC4-EV-4P-40-30	[C] P26H00.	40 A	4	30 mA	Time	5
REC4-EV-4P-63-30	[C] P26H01.	63 A	4	30 mA	Time	5

3 reconnections: 3, 20, 180 s. Complies with the EN 50557 Standard



REC4-EV-C, RCCB with supervision and reclosing 6mADC, type A 12 VAC auxiliary power supply

Type	Code	In (A)	Poles	Sensitivity	Reclosing mode	Módulos
Self-reclosing RCCB with status output						
REC4-EV-C-4P-40-30	[*] P26L00.	40 A	4	30 mA	remote control	5
REC4-EV-C-4P-63-30	[*] P26L01.	63 A	4	30 mA	remote control	5

3 reconnections: 3, 20, 180 s. Complies with the EN 50557 Standard



REC4-EV-C, RCCB with reclosing, type B 12 VAC auxiliary power supply

Type	Code	In (A)	Poles	Sensitivity	Reclosing mode	Módulos
Reclosing RCCB with status output						
REC4-EV-C-4P-40-30	[C] P26M00.	40 A	4	30 mA	remote control	5
REC4-EV-C-4P-63-30	[C] P26M10.	63 A	4	30 mA	remote control	5

REC4-EV-C			
P	2	X	X
X	X	X	X
0	0	0	X
Code	Internal code	↑	Delivery time
Standard 50 Hz	0	-	
Frequency	60 Hz	1	1

Dimensions

REC4-EV-C/ REC4-EV-C

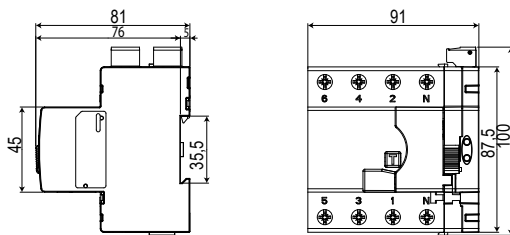

REC4-EV 4P

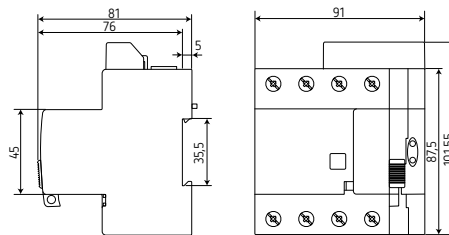

IDA-EV

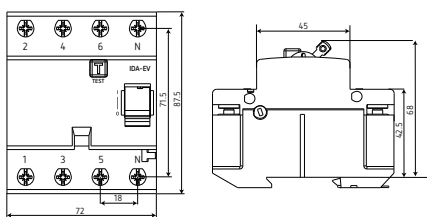

Relays and control elements



IMD-2R Offline insulation relay

Type	Code	Description
IMD-2R	[*] P33020.	Monitoring relay for offline insulation. It controls and monitors the insulation resistance of the receivers that are occasionally disconnected from the electrical network



WI Current detector relay

Type	Code	Trip time (adjustable)	Margin of setting (adjustable)
WI/005-30	[*] P32011.	0,5 ... 30 s	0,5 ... 5 A
WI/010-30	[*] P32012.	0,5 ... 30 s	1 ... 10 A
WI/020-30	[*] P32013.	0,5 ... 30 s	2 ... 20 A
WI/050-30	[*] P32014.	0,5 ... 30 s	5 ... 50 A
WI/100-30	[*] P32015.	0,5 ... 30 s	10 ... 100 A
WI/TS	[*] P32010.	0,5 ... 30 s	s / transf. ... / 5 A

Dimensions

IMD-2R

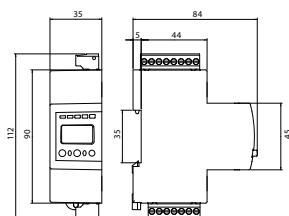

WI

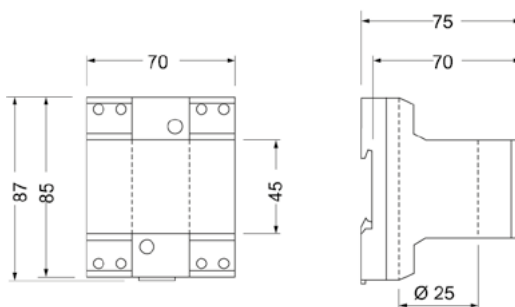

Protection current transformer

TRP model selection table, according to:



- Primary current intensity
- Maximum wiring diameter
- Assigned VA power
- Assigned accuracy/protection class

	TRP 40	TRP 60	TRP 80	TRP 100	TRP 140	TRP 180
	5P10-5P20	5P10-5P20	5P10-5P20	5P10-5P20	5P10-5P20	5P10-5P20
Power (VA)						
100/5	5					
150/5	5	2.5				
200/5	10	2.5				
250/5	10	5	5			
300/5	15	5	5			
400/5	20	7.5	7.5			
500/5	25	10	10			
600/5		10	10			
750/5		15	15			
800/5		15	15			
1 000/5		20	20			
1 200/5			25			
1 250/5			25			
1 500/5			30			
1 600/5			30			
1 800/5			35			
2 000/5						
2 500/5						
3 000/5						
4 000/5						
5 000/5						

	Cable		Cable		Cable	
	Ø 40 mm	Ø 60 mm	Ø 80 mm	Ø 100 mm	Ø 140 mm	Ø 180 mm
600/5						
750/5						
1 200/5						
1 250/5						
1 500/5						
1 600/5						
1 800/5						
2 000/5						
2 500/5						
3 000/5						
4 000/5						
5 000/5						

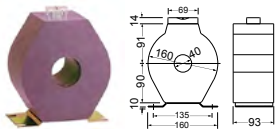
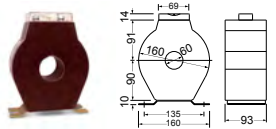
TRP, Protection transformers encapsulated in resin

Type	TRP40-5P10		TRP40-5P20		TRP60-5P10		TRP60-5P20		
									
Usefull diam.(mm)	Ø 40 mm				Ø 60 mm				
Accuracy	5P10		5P20		5P10		5P20		
A	VA	Code	weight (kg)	VA	Code	weight (kg)	VA	Code	weight (kg)
100	5	[4] P50311.	5,00	5	[4] P50211.	9,30			
150	5	[4] P50312.	5,00	5	[4] P50212.	9,40	2.5	[4] P50321.	2,60
200	10	[4] P50313.	5,00	10	[4] P50213.	9,40	2.5	[4] P50322.	2,70
250	10	[4] P50314.	5,00	10	[4] P50214.	9,50	5	[4] P50323.	2,70
300	15	[4] P50315.	5,10	15	[4] P50215.	9,60	5	[4] P50324.	2,70
400	20	[4] P50316.	5,10	20	[4] P50216.	9,60	7.5	[4] P50325.	2,80
500	25	[4] P50317.	5,20	25	[4] P50217.	9,80	10	[4] P50326.	2,80
600							10	[4] P50327.	2,90
750							15	[4] P50328.	3,00
1000							20	[4] P50329.	3,20

Type	TRP80-5P10			TRP80-5P20			TRP100-5P10			TRP100-5P20		
												
Usefull diam.(mm)	ø 80 mm						ø 100 mm					
Accuracy	5P10			5P20			5P10			5P20		
A	VA	Code	weight (kg)	VA	Code	weight (kg)	VA	Code	weight (kg)	VA	Code	weight (kg)
250	5	[4] P50331.	3,20	5	[4] P50231.	5,90						
300	5	[4] P50332.	3,30	5	[4] P50232.	6,00						
400	7,5	[4] P50333.	3,30	7,5	[4] P50233.	5,60						
500	10	[4] P50334.	3,40	10	[4] P50234.	6,20						
600	10	[4] P50335.	3,50	10	[4] P50235.	6,10						
750							5	[4] P50341.	3,40	5	[4] P50241.	5,60
800	15	[4] P50336.	3,60	15	[4] P50236.	6,00						
1000	20	[4] P50337.	3,70	20	[4] P50237.	6,40	7,5	[4] P50342.	3,40	7,5	[4] P50242.	7,30
1200	25	[4] P50338.	3,80	25	[4] P50238.	6,40	10	[4] P50343.	3,40	10	[4] P50243.	7,00
1500	30	[4] P50339.	4,00	30	[4] P50239.	6,60	10	[4] P50344.	3,60	10	[4] P50244.	7,40
2000							15	[4] P50346.	3,70	15	[4] P50246.	8,20
2500							15	[4] P50347.	3,90	15	[4] P50247.	9,00
3000							20	[4] P50348.	4,56	20	[4] P50248.	7,65

Type	TRP140-5P10			TRP140-5P20			TRP180-5P10			TRP180-5P20		
												
Usefull diam.(mm)	ø 140 mm						ø 180 mm					
Accuracy	5P10			5P20			5P10			5P20		
A	VA	Code	weight (kg)	VA	Code	weight (kg)	VA	Code	weight (kg)	VA	Code	weight (kg)
1000	5	[4] P50351.	3,70	5	[4] P50251.	12,20						
1250	5	[4] P50352.	3,80	5	[4] P50252.	12,30						
1500	10	[4] P50353.	3,90	10	[4] P50253.	12,50	5	[4] P50361.	4,50	5	[4] P50261.	8,10
2000	10	[4] P50354.	5,00	10	[4] P50254.	12,80	7,5	[4] P50362.	4,50	7,5	[4] P50262.	16,10
2500	10	[4] P50355.	4,50	10	[4] P50255.	9,25	10	[4] P50363.	5,00	10	[4] P50263.	16,60
3000	15	[4] P50356.	4,60	15	[4] P50256.	8,00	10	[4] P50364.	5,20	10	[4] P50264.	17,20
4000	15	[4] P50357.	5,20	15	[4] P50257.	8,90	15	[4] P50365.	5,70	15	[4] P50265.	9,70
5000							15	[4] P50366.	6,20	15	[4] P50266.	10,60

TRP

P	5	X	X	X	X	0	0	X
Code	Internal code						↑	Delivery time
Secondary current	Standard (.../ 5 A)						0	-
	... / 1A						1	5



TRM, Measure current transformers encapsulated in resin, see section **Measurements and control / Measuring current transformers and shunts**

Measuring and testing equipments for substations



GETEST Step and contact voltage meter

Type	Code	Description	Communications
GETEST 5...50A	[C] P6012300A0000	Indirect earth contact simulator 5 ... 50 A, includes PDA	wireless
Trolley GETEST	[C] P6990A.	Transport trolley GETEST	-
GETEST Probe	[C] P69928.	Measurement electrode	-

Includes the CIRCUTOR laboratory certificate



OT2 Dielectric strenght tester

Type	Code	Description
OT2-60 D	[C] P6031200A0000	Dielectric strenght tester for insulating oil 60 kV

Includes the CIRCUTOR laboratory certificate



MH Microohmmeter

Type	Code	Description	Communications
MH-10r	[C] P6071500A0000	Microohmmeter (Thomson Bridge)	wireless
MH-10/100u	[C] P6071400A0000	Microohmmeter 10 / 100 A	-



MD Digital Megaohmmeters

Type	Code	Description	Communications
Digital megaohmmeter			
MD-5060e	[C] P6052100A0000	Digital megaohmmeter 5 kV (with memory and communications)	-
MD-10kVr	[C] P6052300A0000	Digital megaohmmeter 10 kV	wireless
Analogue megaohmmeter			
MI-20kV	[C] P6051400A0000	Analogue megaohmmeter 20 kV	-



TL6 Earth resistance meter

Type	Code	Description	Communications
TL-6r	[C] P6062300A0000	4-way earth resistance meter	Bluetooth

TABLE OF ADDITIONAL FEATURES

P	6	X	X	X	X	0	0	X
Code	Internal Code						↑	Delivery time
Certificate	ENAC calibration certificate						E	C

Power factor correction and harmonic filtering

Power factor regulators

computer C Wi-Fi Power factor controller with communications	115
computer SMART III Three-phase Power factor controllers. Regulation, measurement, leakage control and communications	115
SmartLink-VAR, RS-485 to Ethernet/WiFi converter for connecting batteries with Computer Smart to the VAR system	115
VAR_Scout Scout software	115
computer SMART III-Fast Power factor controllers for static switching	115

Low voltage power capacitors

CLZ-FP HD 50Hz Three-phase tubular power capacitor (Heavy Duty range).....	116
RD Fast discharging resistors	117
CLZ-FP HD 50Hz Three-phase tubular power capacitor (Heavy Duty range).....	117
CMC B, CMC-B contactors.....	117
ELEB, CSB coils	117
IR Current limiting impedances	117
CLZ-FP HD 60Hz Three-phase tubular power capacitor (Heavy Duty range).....	118
CLZ-FP HD 60Hz Three-phase tubular power capacitor (Heavy Duty range).....	119
CSB Power capacitors for LV.....	120
CFB Power capacitors for detuned filters, type P=7% (fres=189 Hz).....	120
RZ-RBZ Reactors III for detuned filters	121
RZ-RBZ-60Hz, Reactors III for detuned filters, 60 Hz.....	121
CFB-6B Power capacitors for harmonics filters with static switching operation of the FRE series	122
REZ-RBEZ Reactors III for detuned static filters for FRE static switching bank	122
Basic fixed compensation.....	123
CLP-C, CLZ Capacitor with miniature circuit breaker and contactor, 50 Hz.....	123
CSB-M Power capacitors with miniature circuit breaker protection, 50 Hz.....	123
CSB-F Power capacitors with fuse protection, 50 Hz.....	123
Advanced fixed compensation	124
CCF CSB capacitor with contactor and fuses, 50 Hz.....	124
CPA Fixed capacitors with automatic 50-Hz switch protection.....	124
OPTIM FRF Fixed capacitors with detuned reactor of P = 7% (fres=189 Hz), 50 Hz.....	124
OPTIM FRM Fixed capacitors with detuned reactor of P = 7% (fres=189 Hz), 50 Hz.....	124

Low voltage capacitor banks

OPTIM P&P Automatic capacitor banks, 2.5 to 1600 kvar, 50 Hz.....	128
OPTIM FR P&P Automatic capacitor banks with detuned filters (contactors switching), type P=7% (fres=189 Hz), 50 Hz.....	130
OPTIM-SVGm, Combined automatic capacitor banks	132
OPTIM-SVGm-60Hz Combined automatic capacitor banks, 60 Hz.....	132
SVGm-C Static Var Generator with multilevel technology	132
OPTIM EMK Automatic capacitor banks with static contactor, 50 Hz.....	133
CPC3 Zero-crossing control board (for EMF / EMB modules).....	133
EMB-2PH, Three-phase static switching units for 3-terminal capacitors	133
OPTIM FRE Automatic capacitor banks with rejection filters (static contactor), 50 Hz.....	134

Harmonic filters

AFQs, Active multifunction filter.....	138
AFQm, Active multifunction filter, 50 / 60 Hz.....	138
LRZ / LRBZ, Filter reactors for power converters (network side), 50 Hz.....	139
LCL, Harmonic filters for power converters	139

Capacitor and MV accessories

CHV-T Three-phase MV power capacitors	142
CHV-M Single-phase MV power capacitors (indoor and outdoor use)	143
VC Three-phase contactor for MV capacitors.....	144
RMV, Choke reactors for MV capacitor banks	144

MV Automatic capacitor banks

Table: Selection of the reactive energy compensation unit

					Page
Multiple loads	Slow variations	Without harmonics	OPTIM P&P		128
		With harmonics	SVGm	Inmunity to harmonics	132
			OPTIM FR P&P	Elimination of resonances	130
		Quick variations	Without harmonics	OPTIM EMK	
	With harmonics		OPTIM SVGm	Inmunity to harmonics	132
			SVGm	Inmunity to harmonics	132
			OPTIM FRE	Elimination of resonances	134
	Fixed individual compensation	without harmonics	Fuse protection	CSB-F	Transformers
Fuse protection and contactor			CCF	Medium and high-power motors	124
Miniature circuit breaker protection			CSB-M	Medium-power transformers	123
Miniature circuit breaker protection and contactor			CLP-C	Low-power motors	123
Circuit breaker protection			CPA	High power transformers	124
With harmonics		Fuse protection	OPTIM FRF	Elimination of resonances	124
		Circuit breaker protection	OPTIM FRM	Elimination of resonances	124

GUIDE OF SELECTION FOR HARMONIC OR DISTURBANCE FILTERING EQUIPMENT

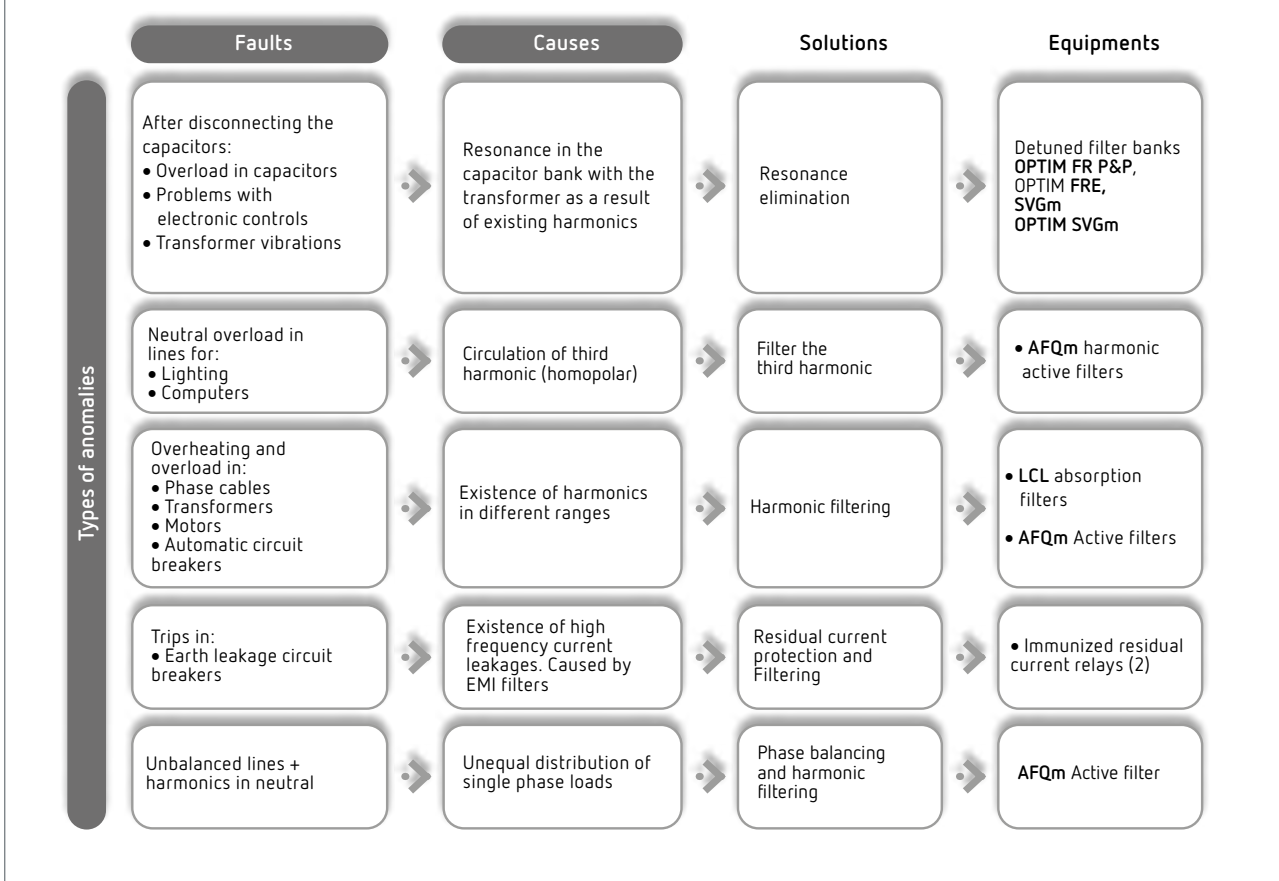

Power factor regulators



computer C Wi-Fi Power factor controller with communications

Type	Code	Power supply	Measurement Range (V)	Input current	Switching unit	Nr steps	Alarm relay	Communications	Size (mm) width x height x depth
computer C6 Wi-Fi	[*] R14831.	400 Vac	400	... / 5A	Contactor	6	●	Wi-Fi	144x144x54.85
computer C6 Wi-Fi	[*] R148310020000	230 Vac	230	... / 5A	Contactor	6	●	Wi-Fi	144x144x54.85
computer C12 Wi-Fi	[*] R14842.	400 Vac	400	... / 5A	Contactor	12	●	Wi-Fi	144x144x54.85
computer C12 Wi-Fi	[*] R148420020000	230 Vac	230	... / 5A	Contactor	12	●	Wi-Fi	144x144x54.85

Compatible with Anti Reactive Surveillance System - VAR. Programming via the MyConfig app.



computer SMART III Three-phase Power factor controllers. Regulation, measurement, leakage control and communications

Type	Code	Power supply	Measurement Range (V)	Input current	Switching unit	Idn	Nr steps	Alarm relay	Communications	Size (mm) width x height x depth
computer SMART III 6	[*] R13851.	100...520 Vac	20...300	.../5A .../1A	Contactor	yes	6	●	RS-485	144x144x71
computer SMART III 12	[*] R13862.	100...520 Vac	20...300	.../5A .../1A	Contactor	yes	12	●	RS-485	144x144x71
computer SMART III 14	[*] R13864.	100...400 Vac	20...300	.../5A .../1A	Contactor	yes	14	●	RS-485	144x144x71



SmartLink-VAR, RS-485 to Ethernet/WiFi converter for connecting batteries with Computer Smart to the VAR system

Type	Code	Description
SmartLink-VAR	[*] R1LVAR.	RS-485 to Ethernet/Wi-Fi converter to connect the batteries with Computer Smart to the VAR system

NEW

**Scout
VAR**

VAR_Scout Scout software Cloud-Scout Electrical monitoring and auditing software

Type	Code	Description
VAR_Scout	[*] W10340.	Module for battery performance and power factor monitoring

Module prices are annual subscription prices per connected device.
Equipment compatible with the modules: VAR: computer C Wi-Fi, computer SMART III connected with SmartLink-VAR converter.

Fast power factor regulator (static switching)



computer SMART III-Fast Power factor controllers for static switching

Type	Code	Power supply	Measurement Range (V)	Input current	Switching unit	Idn	Nr steps	Alarm relay	Communications	Size (mm) width x height x depth
computer SMART III F6-12Vdc	[*] R13953.	100...520 Vac	100...520	.../5A .../1A	EMB-2PH	yes	6	●	RS-485	144x144x71
computer SMART III F12-12Vdc	[*] R13964.	100...520 Vac	100...520	.../5A .../1A	EMB-2PH	yes	12	●	RS-485	144x144x71
computer SMART III Fast 6	[*] R13951.	100...520 Vac	100...520	.../5A .../1A	EMF / EMB	yes	6	●	RS-485	144x144x71
computer SMART III Fast 12	[*] R13962.	100...520 Vac	100...520	.../5A .../1A	EMF / EMB	yes	12	●	RS-485	144x144x71

Dimensions

computer Smart III / computer SMART III fast

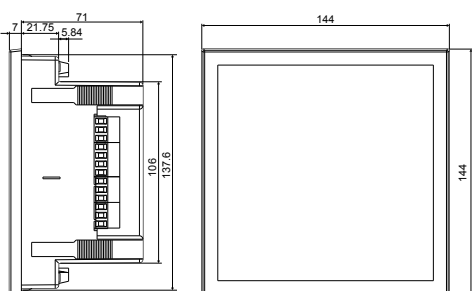

computer C Wi-Fi

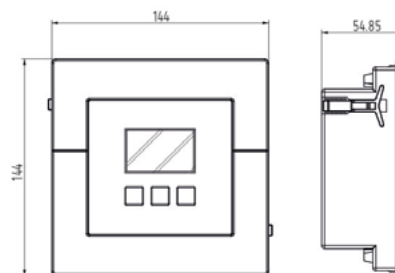

Low voltage power capacitors



CLZ-FP HD 50Hz Three-phase tubular power capacitor (Heavy Duty range)

CLZ-FPT - Capacitors with Faston terminal / CLZ-FP - Capacitors with terminal block

Type	Code	220 V kvar	230 V kvar	Hz	dia.x height (mm)	weight (kg)	Terminal
Terminal block, Un = 3 x 230 V / 50 Hz							
CLZ-FP-23/5-HD	[C] R2H516.	4.6	5	50	85 x 175	0,81	A
CLZ-FP-23/6,25-HD	[C] R2H517.	5.7	6.25	50	85 x 245	1,00	A
CLZ-FP-23/7,5-HD	[C] R2H518.	6.8	7.5	50	85 x 245	1,07	A
CLZ-FP-23/10-HD	[C] R2H51B.	9.15	10	50	100 x 245	1,38	A
CLZ-FP-23/12,5-HD	[C] R2H51D.	11.4	12.5	50	100 x 245	1,60	A
CLZ-FP-23/15-HD	[C] R2H51E.	13.75	15	50	116 x 245	1,94	B

All models are of the inert gas type, except for those with a 63.5 mm diameter and 136x355 mm size The dimensions (dxh) are shown for the tube only. Please consult the dimensions drawing at the end of this section for more information about the actual dimensions Terminal: maximum cross-section of type A cables: 16 mm², type B: 25 mm², type C: 35 mm², F: Faston 6.3x0.8 mm and 12 A maximum current

Type	Code	400 V kvar	440 V kvar	Hz	dia.x height (mm)	weight (kg)	Terminal
Faston terminal, Un = 3 x 440 V / 50 Hz							
CLZ-FPT-44/1,25-HD	[C] R2H541.	1	1.25	50	63,5 x 98	0,36	F
CLZ-FPT-44/2,5-HD	[*] R2H542.	2	2.5	50	63,5 x 127	0,44	F
CLZ-FPT-44/3-HD	[C] R2H543.	2.5	3	50	63,5 x 127	0,46	F
CLZ-FPT-44/3,75-HD	[C] R2H544.	3	3.75	50	63,5 x 127	0,47	F
CLZ-FPT-44/5-HD	[*] R2H546.	4	5	50	63,5 x 175	0,62	F
CLZ-FPT-44/6,25-HD	[*] R2H547.	5	6.25	50	63,5 x 175	0,62	F
CLZ-FPT-44/7,5-HD	[*] R2H848.	6.25	7.5	50	63,5 x 202	0,71	F

Terminal block, Un = 3 x 440 V / 50 Hz

CLZ-FP-44/10-HD	[*] R2H54B.	8	10	50	85 x 245	0,90	A
CLZ-FP-44/12,5-HD	[*] R2H54D.	10	12.5	50	85 x 245	1,01	A
CLZ-FP-44/15-HD	[*] R2H54E.	12.5	15	50	85 x 245	1,09	A
CLZ-FP-44/18,2-HD	[C] R2H54G.	15	18.2	50	100 x 245	1,38	A
CLZ-FP-44/20-HD	[*] R2H54J.	16	20	50	100 x 245	1,46	A
CLZ-FP-44/25-HD	[*] R2H54L.	20	25	50	100 x 245	1,69	B
CLZ-FP-44/30-HD	[*] R2H54N.	25	30	50	116 x 245	1,99	B
CLZ-FP-44/40-HD	[C] R2H54R.	32	40	50	136 x 261	5,00	B
CLZ-FP-44/50-HD	[*] R2H54S.	40	50	50	136 x 355	5,18	C

All models are of the inert gas type, except for those with a 63.5 mm diameter and 136x355 mm size The dimensions (dxh) are shown for the tube only. Please consult the dimensions drawing at the end of this section for more information about the actual dimensions Terminal: maximum cross-section of type A cables: 16 mm², type B: 25 mm², type C: 35 mm², F: Faston 6.3x0.8 mm and 12 A maximum current

Type	Code	440 V kvar	460 V kvar	Hz	dia.x height (mm)	weight (kg)	Terminal
Faston terminal, Un = 3 x 460 V / 50 Hz							
CLZ-FPT-46/6,25-HD	[*] R2H857.	5.7	6.25	50	63,5 x 202	0,70	F

Terminal block, Un = 3 x 460 V / 50 Hz

CLZ-FP-46/12,5-HD	[*] R2H55D.	11.4	12.5	50	85 x 245	1,10	A
CLZ-FP-46/15-HD	[*] R2H55E.	13.7	15	50	85 x 245	1,27	A
CLZ-FP-46/19-HD	[*] R2H55H.	17.4	19	50	100 x 245	1,53	A
CLZ-FP-46/25-HD	[*] R2H55L.	22.9	25	50	116 x 245	2,03	B
CLZ-FP-46/30-HD	[*] R2H55N.	27.4	30	50	136 x 220	2,45	B
CLZ-FP-46/33.3-HD	[C] R2H55P.	30.5	33.3	50	136 x 261	3,20	B

All models are of the inert gas type, except for those with a 63.5 mm diameter and 136x355 mm size The dimensions (dxh) are shown for the tube only. Please consult the dimensions drawing at the end of this section for more information about the actual dimensions Terminal: maximum cross-section of type A cables: 16 mm², type B: 25 mm², type C: 35 mm², F: Faston 6.3x0.8 mm and 12 A maximum current

Type	Code	460 V kvar	480 V kvar	Hz	dia.x height (mm)	weight (kg)	Terminal
Terminal block, Un = 3 x 480 V / 50 Hz							
CLZ-FP-48/10-HD	[C] R2H56B.	9.2	10	50	85 x 245	0,93	A
CLZ-FP-48/12,5-HD	[C] R2H56D.	11.5	12.5	50	85 x 245	1,07	A
CLZ-FP-48/15-HD	[C] R2H56E.	13.8	15	50	85 x 245	1,18	A
CLZ-FP-48/25-HD	[C] R2H56L.	23	25	50	116 x 245	1,90	B
CLZ-FP-48/28,2-HD	[C] R2H56M.	26	28.2	50	116 x 245	2,15	B
CLZ-FP-48/30-HD	[C] R2H56N.	27.6	30	50	116 x 245	2,15	B
CLZ-FP-48/40-HD	[C] R2H56R.	36.75	40	50	136 x 261	2,90	B

All models are of the inert gas type, except for those with a 63.5 mm diameter and 136x355 mm size The dimensions (dxh) are shown for the tube only. Please consult the dimensions drawing at the end of this section for more information about the actual dimensions Terminal: maximum cross-section of type A cables: 16 mm², type B: 25 mm², type C: 35 mm², F: Faston 6.3x0.8 mm and 12 A maximum current



CLZ-FP HD 50Hz Three-phase tubular power capacitor (Heavy Duty range)

CLZ-FPT - Capacitors with Faston terminal / CLZ-FP - Capacitors with terminal block

Type	Code	500 V kvar	525 V kvar	Hz	dia.x height (mm)	weight (kg)	Terminal
Faston terminal, Un = 3 x 525 V / 50 Hz							
CLZ-FPT-52/5-HD	[*] R2H876.	4,5	5	50	63,5 x 175	0,61	F
Terminal block, Un = 3 x 525 V / 50 Hz							
CLZ-FP-52/8-HD	[C] R2H579.	7,25	8	50	85 x 175	0,86	A
CLZ-FP-52/10-HD	[*] R2H57B.	9,1	10	50	85 x 245	0,99	A
CLZ-FP-52/12,5-HD	[*] R2H57D.	11,3	12,5	50	85 x 245	1,13	A
CLZ-FP-52/15-HD	[*] R2H57E.	13,6	15	50	85 x 245	1,20	A
CLZ-FP-52/20-HD	[*] R2H57J.	18,15	20	50	100 x 245	1,62	A
CLZ-FP-52/25-HD	[*] R2H57L.	22,7	25	50	116 x 245	1,63	B
CLZ-FP-52/30-HD	[*] R2H57N.	27,2	30	50	116 x 245	2,18	B
CLZ-FP-52/40-HD	[C] R2H57R.	36,3	40	50	136 x 261	2,80	B
CLZ-FP-52/50-HD	[C] R2H57S.	45,4	50	50	136 x 355	5,24	C

All models are of the inert gas type, except for those with a 63.5 mm diameter and 136x355 mm size The dimensions (dxh) are shown for the tube only. Please consult the dimensions drawing at the end of this section for more information about the actual dimensions Terminal: maximum cross-section of type A cables: 16 mm², type B: 25 mm², type C: 35 mm², F: Faston 6.3x0.8 mm and 12 A maximum current

Type	Code	660 V kvar	690 V kvar	Hz	dia.x height (mm)	weight (kg)	Terminal
Terminal block, Un = 3 x 690 V / 50 Hz							
CLZ-FP-69/7,5-HD	[C] R2H598.	6,9	7,5	50	85 x 175	0,95	A
CLZ-FP-69/10-HD	[C] R2H59B.	9,15	10	50	85 x 245	1,00	A
CLZ-FP-69/12,5-HD	[C] R2H59D.	11,4	12,5	50	85 x 245	1,10	A
CLZ-FP-69/15-HD	[C] R2H59E.	13,7	15	50	85 x 245	1,20	A
CLZ-FP-69/20-HD	[C] R2H59J.	18,3	20	50	100 x 245	1,70	A
CLZ-FP-69/25-HD	[C] R2H59L.	22,9	25	50	116 x 245	1,90	B
CLZ-FP-69/30-HD	[C] R2H59N.	27,5	30	50	136 x 220	3,30	B
CLZ-FP-69/40-HD	[C] R2H59R.	36,6	40	50	136 x 355	5,00	C
CLZ-FP-69/50-HD	[C] R2H59S.	45,75	50	50	136 x 355	5,50	C

All models are of the inert gas type, except for those with a 63.5 mm diameter and 136x355 mm size The dimensions (dxh) are shown for the tube only. Please consult the dimensions drawing at the end of this section for more information about the actual dimensions Terminal: maximum cross-section of type A cables: 16 mm², type B: 25 mm², type C: 35 mm², F: Faston 6.3x0.8 mm and 12 A maximum current



CMC B, CMC-B contactors

Type	Code	220-240V kvar	400-440-480 V kvar	500-550 V kvar	660-690 V kvar	Hz	Size (mm) width x height x depth	weight (kg)
Maximum operating power (Kvar)								
CMC 7,5 B	[C] R281A5.	5	7,5	9	11	50 / 60	44.8x72.2x71	0,28
CMC 12 B	[C] R281A6.	6,7	12,5	15	18	50 / 60	44.8x72.2x107.9	0,32
CMC 20 B	[C] R281A4.	11	20	24	30	50 / 60	54.8x72.2x107.9	0,38
CMC 32 B	[C] R281A8.	14	25	30	35	50 / 60	54.6x80x121.4	0,47
CMC 40 B	[C] R281A1.	20	30	35	40	50 / 60	54.8x80x124.5	0,60
CMC 75 B	[C] R281A9.	29	50	60	70	50 / 60	64.6x120x150	1,00
CMC 85 B	[C] R281A3.	32	60	70	80	50 / 60	64.6x120x150	0,85
CMC 150 D	[C] R281AH.	45	80	100	115	50 / 60	90x179x192	2,40

RD Fast discharging resistors

Type	Code	Impedance (Ω)	Dissipated power (w)
RD-60 2X1000	[*] R3Z220.	2 x 1000	10
RD-100 2X1000	[*] R3Z230.	2 x 1000	15



IR Current limiting impedances

Type	Code	Cable section (mm ²)
IR-6	[*] R3Z310.	6
IR-10	[*] R3Z320.	10
IR-25	[*] R3Z330.	25
IR-50	[*] R3Z350.	50



ELEB CSB coils

Type	Code	Use voltage (V)	μF
ELEB10100PCA	[1] R213A8.	230	100
ELEB10150PCA	[1] R213AE.	230	150
ELEB14055PCA	[1] R2139D.	400/440/690(*)	55
ELEB14069PCA	[1] R2139H.	400/440/690(*)	69
ELEB14082PCA	[1] R2139R.	400/440/690(*)	82

Type	Code	Use voltage (V)	μF
ELEB18027PCA	[1] R2137T.	460	27.4
ELEB18035PCA	[1] R2137A.	460	35
ELEB18050PCA	[1] R2137P.	460	50
ELEB20019PCA	[1] R2138D.	480/525/550	19.2
ELEB20038PCA	[1] R2138G.	480/525/550	38.4

(*) Wye (star) connection



CLZ-FP HD 60Hz Three-phase tubular power capacitor (Heavy Duty range)

CLZ-FPT - Capacitors with Faston terminal / CLZ-FP - Capacitors with with terminal block

Type	Code	230 V kvar	240 V kvar	Hz	dia.x height (mm)	weight (kg)	Terminal
------	------	------------	------------	----	-------------------	-------------	----------

Faston terminal, Un = 3 x 240 V / 60 Hz

CLZ-FPT-24/2,5-60Hz-HD	[C] R2H622.	2.3	2.5	60	63,5 x 127	0,57	F
------------------------	-------------	-----	-----	----	------------	------	---

Terminal block, Un = 3 x 240 V / 60 Hz

CLZ-FP-24/5-60Hz-HD	[C] R2H626.	4.6	5	60	85 x 175	0,85	A
CLZ-FP-24/6,25-60Hz-HD	[C] R2H627.	5.75	6.25	60	85 x 175	0,84	A
CLZ-FP-24/7,5-60Hz-HD	[C] R2H628.	6.9	7.5	60	85 x 245	0,96	A
CLZ-FP-24/10-60Hz-HD	[C] R2H62B.	9.2	10	60	85 x 245	1,06	A
CLZ-FP-24/12,5-60Hz-HD	[C] R2H62D.	11.5	12.5	60	85 x 245	1,25	A
CLZ-FP-24/15-60Hz-HD	[C] R2H62E.	13.8	15	60	100 x 245	1,51	A

All models are of the inert gas type, except for those with a 63.5 mm diameter and 136x355 mm size The dimensions (dxh) are shown for the tube only. Please consult the dimensions drawing at the end of this section for more information about the actual dimensions Terminal: maximum cross-section of type A cables: 16 mm2, type B: 25 mm2, type C: 35 mm2, F: Faston 6.3x0.8 mm and 12 A maximum current

Type	Code	400 V kvar	440 V kvar	Hz	dia.x height (mm)	weight (kg)	Terminal
------	------	------------	------------	----	-------------------	-------------	----------

Faston terminal, Un = 3 x 440 V / 60 Hz

CLZ-FPT-44/1,25-60Hz-HD	[C] R2H641.	1	1.25	60	63,5 x 98	0,37	F
CLZ-FPT-44/2,5-60Hz-HD	[C] R2H642.	2.1	2.5	60	63,5 x 127	0,44	F
CLZ-FPT-44/3-60Hz-HD	[C] R2H643.	2.5	3	60	63,5 x 127	0,50	F
CLZ-FPT-44/3,75-60Hz-HD	[C] R2H644.	3.1	3.75	60	63,5 x 127	0,44	F
CLZ-FPT-44/5-60Hz-HD	[C] R2H646.	4.15	5	60	63,5 x 127	1,20	F

Terminal block, Un = 3 x 440 V / 60 Hz

CLZ-FP-44/6,25-60Hz-HD	[C] R2H647.	5.2	6.25	60	85 x 175	0,67	A
CLZ-FP-44/7,5-60Hz-HD	[C] R2H648.	6.2	7.5	60	85 x 175	0,75	A
CLZ-FP-44/10-60Hz-HD	[C] R2H64B.	8.3	10	60	85 x 175	0,87	A
CLZ-FP-44/12,5-60Hz-HD	[C] R2H64D.	10.3	12.5	60	85 x 245	0,90	A
CLZ-FP-44/15-60Hz-HD	[C] R2H64E.	12.4	15	60	85 x 245	0,98	A
CLZ-FP-44/20-60Hz-HD	[C] R2H64J.	16.5	20	60	85 x 245	1,14	A
CLZ-FP-44/25-60Hz-HD	[C] R2H64L.	20.7	25	60	100 x 245	1,46	A
CLZ-FP-44/30-60Hz-HD	[C] R2H64N.	24.8	30	60	116 x 245	1,78	B
CLZ-FP-44/40-60Hz-HD	[C] R2H64R.	33.1	40	60	136 x 220	2,38	B
CLZ-FP-44/50-60Hz-HD	[C] R2H64S.	41.3	50	60	136 x 355	5,10	C

All models are of the inert gas type, except for those with a 63.5 mm diameter and 136x355 mm size The dimensions (dxh) are shown for the tube only. Please consult the dimensions drawing at the end of this section for more information about the actual dimensions Terminal: maximum cross-section of type A cables: 16 mm2, type B: 25 mm2, type C: 35 mm2, F: Faston 6.3x0.8 mm and 12 A maximum current

Type	Code	460 V kvar	480 V kvar	Hz	dia.x height (mm)	weight (kg)	Terminal
------	------	------------	------------	----	-------------------	-------------	----------

Faston terminal, Un = 3 x 480 V / 60 Hz

CLZ-FPT-48/2,5-60Hz-HD	[C] R2H762.	2.3	2.5	60	63,5 x 127	0,47	F
CLZ-FPT-48/5-60Hz-HD	[C] R2H766.	4.6	5	60	63,5 x 175	0,62	F
CLZ-FPT-48/6,25-60Hz-HD	[C] R2H767.	5.75	6.25	60	63,5 x 175	0,90	F
CLZ-FPT-48/7,5-60Hz-HD	[C] R2H768.	6.9	7.5	60	63,5 x 175	0,61	F

Terminal block, Un = 3 x 480 V / 60 Hz

CLZ-FP-48/10-60Hz-HD	[C] R2H66B.	9.2	10	60	85 x 175	0,85	A
CLZ-FP-48/12,5-60Hz-HD	[C] R2H66D.	11.5	12.5	60	85 x 245	0,97	A
CLZ-FP-48/15-60Hz-HD	[C] R2H66E.	13.8	15	60	85 x 245	1,07	A
CLZ-FP-48/20-60Hz-HD	[C] R2H66J.	18.4	20	60	100 x 245	1,32	A
CLZ-FP-48/25-60Hz-HD	[C] R2H66L.	23	25	60	100 x 245	1,57	B
CLZ-FP-48/30-60Hz-HD	[C] R2H66N.	27.6	30	60	116 x 245	1,86	B
CLZ-FP-48/40-60Hz-HD	[C] R2H66R.	36.75	40	60	136 x 220	2,43	B
CLZ-FP-48/50-60Hz-HD	[C] R2H66S.	46	50	60	136 x 355	5,00	C

All models are of the inert gas type, except for those with a 63.5 mm diameter and 136x355 mm size The dimensions (dxh) are shown for the tube only. Please consult the dimensions drawing at the end of this section for more information about the actual dimensions Terminal: maximum cross-section of type A cables: 16 mm2, type B: 25 mm2, type C: 35 mm2, F: Faston 6.3x0.8 mm and 12 A maximum current

Type	Code	480 V kvar	525 V kvar	Hz	dia.x height (mm)	weight (kg)	Terminal
------	------	------------	------------	----	-------------------	-------------	----------

Faston terminal, Un = 3 x 525 V / 60 Hz

CLZ-FPT-52/2,5-60Hz-HD	[C] R2H772.	2.1	2.5	60	63,5 x 127	0,45	F
CLZ-FPT-52/5-60Hz-HD	[C] R2H776.	4.2	5	60	63,5 x 175	3,00	F
CLZ-FPT-52/6,25-60Hz-HD	[C] R2H777.	5.2	6.25	60	63,5 x 175	0,72	F
CLZ-FPT-52/7,5-60Hz-HD	[C] R2H778.	6.25	7.5	60	63,5 x 202	0,33	F

Terminal block, Un = 3 x 525 V / 60 Hz

CLZ-FP-52/8,5-60Hz-HD	[C] R2H67A.	7.1	8.5	60	85 x 175	0,85	A
CLZ-FP-52/10-60Hz-HD	[C] R2H67B.	8.4	10	60	85 x 175	0,91	A
CLZ-FP-52/11,5-60Hz-HD	[C] R2H67C.	9.6	11.5	60	85 x 245	0,97	A
CLZ-FP-52/12,5-60Hz-HD	[C] R2H67D.	10.5	12.5	60	85 x 245	0,99	A
CLZ-FP-52/15-60Hz-HD	[C] R2H67E.	12.5	15	60	85 x 245	1,11	A
CLZ-FP-52/17-60Hz-HD	[C] R2H67I.	14.2	17	60	85 x 245	1,17	A
CLZ-FP-52/20-60Hz-HD	[C] R2H67J.	16.7	20	60	100 x 245	1,45	A
CLZ-FP-52/22,5-60Hz-HD	[C] R2H67K.	18.8	22.5	60	100 x 245	1,50	A
CLZ-FP-52/25-60Hz-HD	[C] R2H67L.	20.9	25	60	100 x 245	1,66	A
CLZ-FP-52/30-60Hz-HD	[C] R2H67N.	25	30	60	116 x 245	1,95	B
CLZ-FP-52/34-60Hz-HD	[C] R2H67P.	28.4	34	60	116 x 245	2,13	B
CLZ-FP-52/40-60Hz-HD	[C] R2H67R.	33.4	40	60	136 x 261	5,00	B

All models are of the inert gas type, except for those with a 63.5 mm diameter and 136x355 mm size The dimensions (dxh) are shown for the tube only. Please consult the dimensions drawing at the end of this section for more information about the actual dimensions Terminal: maximum cross-section of type A cables: 16 mm2, type B: 25 mm2, type C: 35 mm2, F: Faston 6.3x0.8 mm and 12 A maximum current



CLZ-FP HD 60Hz Three-phase tubular power capacitor (Heavy Duty range)

CLZ-FPT - Capacitors with Faston terminal / CLZ-FP - Capacitors with with terminal block

Type	Code	600 V kvar	Hz	dia.x height (mm)	weight (kg)	Terminal
Faston terminal, Un = 3 x 600 V / 60 Hz						
CLZ-FPT-60/2,5-60Hz-HD	[C] R2H782.	2.5	60	63,5 x 127	0,70	F
CLZ-FPT-60/5-60Hz-HD	[C] R2H786.	5	60	63,5 x 175	1,20	F
CLZ-FPT-60/6,25-60Hz-HD	[C] R2H787.	6.25	60	63,5 x 175	0,90	F
CLZ-FPT-60/7,5-60Hz-HD	[C] R2H788.	7.5	60	63,5 x 175	1,20	F
Terminal block, Un = 3 x 600 V / 60 Hz						
CLZ-FP-60/10-60Hz-HD	[C] R2H68A.	10	60	85 x 175	1,50	A
CLZ-FP-60/12,5-60Hz-HD	[C] R2H68B.	12.5	60	85 x 245	1,50	A
CLZ-FP-60/15-60Hz-HD	[C] R2H68E.	15	60	85 x 245	1,30	A
CLZ-FP-60/17,5-60Hz-HD	[C] R2H68I.	17.5	60	85 x 245	1,25	A
CLZ-FP-60/20-60Hz-HD	[C] R2H68J.	20	60	100 x 245	1,60	A
CLZ-FP-60/21-60Hz-HD	[C] R2H68K.	21	60	100 x 245	1,60	A
CLZ-FP-60/25-60Hz-HD	[C] R2H68L.	25	60	100 x 245	1,60	A
CLZ-FP-60/30-60Hz-HD	[C] R2H68N.	30	60	116 x 245	2,40	B
CLZ-FP-60/34,5-60Hz-HD	[C] R2H68P.	34.5	60	136 x 261	3,00	B

All models are of the inert gas type, except for those with a 63.5 mm diameter and 136x355 mm size The dimensions (dxh) are shown for the tube only. Please consult the dimensions drawing at the end of this section for more information about the actual dimensions Terminal: maximum cross-section of type A cables: 16 mm², type B: 25 mm², type C: 35 mm², F: Faston 6.3x0.8 mm and 12 A maximum current

Type	Code	660 V kvar	690 V kvar	Hz	dia.x height (mm)	weight (kg)	Terminal
Faston terminal, Un = 3 x 690 V / 60 Hz							
CLZ-FPT-69/2,5-60Hz-HD	[C] R2H792.	2.3	2.5	60	63,5 x 127	0,50	F
CLZ-FPT-69/7,5-60Hz-HD	[C] R2H798.	6.9	7.5	60	63,5 x 202	1,10	F
Terminal block, Un = 3 x 690 V / 60 Hz							
CLZ-FP-69/10-60Hz-HD	[C] R2H69B.	9.15	10	60	85 x 245	1,50	A
CLZ-FP-69/12,5-60Hz-HD	[C] R2H69D.	11.4	12.5	60	85 x 245	1,50	A
CLZ-FP-69/15-60Hz-HD	[C] R2H69E.	13.7	15	60	85 x 245	1,40	A
CLZ-FP-69/20-60Hz-HD	[C] R2H69J.	18.3	20	60	100 x 245	2,00	A
CLZ-FP-69/25-60Hz-HD	[C] R2H69L.	22.9	25	60	116 x 245	1,76	B
CLZ-FP-69/30-60Hz-HD	[C] R2H69N.	27.5	30	60	116 x 245	2,50	B
CLZ-FP-69/40-60Hz-HD	[C] R2H69R.	36.6	40	60	136 x 220	3,00	B
CLZ-FP-69/50-60Hz-HD	[C] R2H69S.	45.75	50	60	136 x 355	5,00	C

All models are of the inert gas type, except for those with a 63.5 mm diameter and 136x355 mm size The dimensions (dxh) are shown for the tube only. Please consult the dimensions drawing at the end of this section for more information about the actual dimensions Terminal: maximum cross-section of type A cables: 16 mm², type B: 25 mm², type C: 35 mm², F: Faston 6.3x0.8 mm and 12 A maximum current



CSB Power capacitors for LV

Type	Code	kvar 50 Hz	kvar 60 Hz	Size (mm) width x height x depth	weight (kg)
230 Vac					
CSB-23/10	[*] R2321C.	10	12.5	359x330x120	6,37
CSB-23/12,5	[2] R2321D.	12.5	15	360x330x120	3,30
CSB-23/15	[*] R2321E.	15	17.5	360x330x120	6,00
CSB-23/20	[*] R2321F.	20	25	360x330x120	6,80
CSB-23/25	[2] R2321G.	25	30	360x330x120	7,90
CSB-23/30	[2] R2321H.	30	35	360x330x120	8,00
CSB-23/40	[*] R2321J.	40	50	360x520x120	12,00
CSB-23/50	[*] R2321K.	50	60	360x520x120	12,00
400 Vac					
CSB-40/15	[*] R2323E.	15	17.5	360x330x120	5,76
CSB-40/20	[*] R2323F.	20	25	360x330x120	6,01
CSB-40/25	[*] R2323G.	25	30	360x330x120	5,68
CSB-40/30	[*] R2323H.	30	35	360x330x120	6,70
CSB-40/40	[*] R2323J.	40	50	360x330x120	7,70
CSB-40/50	[*] R2323K.	50	60	360x330x120	7,60
CSB-40/60	[*] R2323L.	60	70	360x520x120	10,80
CSB-40/80	[*] R2323Q.	80	95	360x520x120	12,85
CSB-40/100	[*] R2323R.	100	120	360x520x120	13,50
440 Vac					
CSB-44/15	[*] R2324E.	15	17.5	360x330x120	4,70
CSB-44/20	[*] R2324F.	20	25	360x330x120	4,90
CSB-44/25	[2] R2324G.	25	30	360x330x120	5,90
CSB-44/30	[*] R2324H.	30	35	360x330x120	5,60
CSB-44/40	[*] R2324J.	40	50	360x330x120	7,00
CSB-44/50	[*] R2324K.	50	60	360x330x120	7,80
CSB-44/60	[*] R2324L.	60	70	360x330x120	7,30
CSB-44/80	[*] R2324Q.	80	95	360x520x120	11,80
CSB-44/100	[*] R2324R.	100	120	360x520x120	12,90
460 Vac					
CSB-46/15	[2] R2325E.	15	17.5	360x330x120	6,00
CSB-46/20	[*] R2325F.	20	25	360x330x120	6,11
CSB-46/25	[2] R2325G.	25	30	360x330x120	6,90
CSB-46/30	[*] R2325H.	30	35	360x330x120	6,95
CSB-46/40	[*] R2325J.	40	50	360x330x120	7,60
CSB-46/50	[*] R2325K.	50	60	360x520x120	8,20
CSB-46/60	[*] R2325L.	60	70	360x520x120	11,40
CSB-46/80	[*] R2325Q.	80	95	360x520x120	13,00
CSB-46/100	[*] R2325R.	100	120	360x610x120	16,00



CFB Power capacitors for detuned filters, type P=7% (fres=189 Hz)

Type	Code	400 V kvar	440 V kvar	690 V kvar	For reactor	Size (mm) width x height x depth	weight (kg)
CFB 460							
CFB-46/6	[1] R2415A.	5	6.25	-	RZ-6,25-460	360x330x120	3,30
CFB-46/7,5	[1] R2415B.	9.3	7.75	-	RZ-7,5-460	360x330x120	3,30
CFB-46/12,5	[1] R2415D.	10	12.5	-	RZ-10-400	360x330x120	6,00
CFB-46/15	[1] R2415E.	12.5	15	-	RZ-12,5-400	360x330x120	3,90
CFB-46/19	[1] R2415F.	15	18.5	-	RZ-15-400	360x330x120	5,80
CFB-46/25	[1] R2415G.	20	25	-	RBZ-20-400	360x330x120	6,80
CFB-46/30	[1] R2415H.	25	30	-	RBZ-25-400	360x330x120	6,80
CFB-46/37	[1] R2415J.	30	40	-	RBZ-30-400	360x330x120	7,60
CFB-46/50	[*] R2415K.	40	50	-	RBZ-40-400	360x520x120	10,50
CFB-46/62	[*] R2415L.	50	60	-	RBZ-50-400	360x520x120	11,00
CFB-46/74	[*] R2415P.	60	75	-	RBZ-60-400	360x520x120	12,90
CFB-46/100	[*] R2415R.	80	100	-	RBZ-80-400	360x610x120	16,10
CFB 790							
CFB-79/6	[C] R241DA.	-	-	5	REZ-5-400	360x330x120	2,60
CFB-79/12,5	[C] R241DD.	-	-	10	REZ-10-400	360x330x120	2,60
CFB-79/19	[C] R241DF.	-	-	15	REZ-15-400	360x330x120	3,30
CFB-79/25	[C] R241DG.	-	-	20	REZ-20-400	360x330x120	6,10
CFB-79/30	[C] R241DH.	-	-	25	REZ-25-400	360x330x120	7,00
CFB-79/37	[C] R241DI.	-	-	30	REZ-30-400	360x330x120	7,00
CFB-79/50	[C] R241DK.	-	-	40	REZ-40-400	360x520x120	11,00
CFB-79/62	[C] R241DL.	-	-	50	RBEZ-50-400	360x520x120	13,00
CFB-79/74	[C] R241DP.	-	-	60	RBEZ-60-400	360x520x120	14,00
CFB-79/100	[C] R241DR.	-	-	80	RBEZ-80-400	360x610x120	15,00

NOTE: The capacitor has been sized for 460/790 V and a power that is 20% higher than that indicated in all columns to compensate for the overvoltage effect of the reactor.



RZ-RBZ Reactors III for detuned filters

Type	Code	400 V kvar	Hz	For capacitor	In (A)	L(mH)	Losses (W)	Size (mm) width x height x depth	weight (kg)
400 Vac, 50 Hz, f resonance = 189 Hz / p= 7%									
RZ-5-400	[*] P73110.	5	50	CLZ-FP-46/6,25	7,2	7.66	26	155x165x92	4,00
RZ-6,25-400	[*] P73112.	6.25	50	CLZ-FP-52/10	9	6.1	33	180x190x100	6,00
RZ-10-400	[*] P73115.	10	50	CLZ-FP-46/12,5	15	3.83	52	180x190x100	6,50
RZ-12,5-400	[*] P73117.	12.5	50	CLZ-FP-46/15	18	3.05	57	180x192x110	7,00
RZ-15-400	[*] P73120.	15	50	CLZ-FP-46/19	22	2.55	59	180x190x110	8,00
RBZ-20-400	[*] P73125.	20	50	CLZ-FP-46/25	29	1.91	79	235x165x125	14,00
RBZ-25-400	[*] P73130.	25	50	CLZ-FP-46/30	36	1.53	93	235x165x125	14,00
RBZ-30-400	[*] P73135.	30	50	2 x CLZ-FP-46/19	43	1.27	124	255x200x125	19,00
RBZ-40-400	[*] P73140.	40	50	2 x CLZ-FP-46/25	58	0.95	149	255x200x125	20,00
RBZ-50-400	[*] P73145.	50	50	2 x CLZ-FP-46/30	72	0.76	189	255x220x145	25,00
RBZ-60-400	[*] P73150.	60	50	3 x CLZ-FP-46/25	87	0.63	210	255x240x145	28,00
RBZ-80-400	[*] P73155.	80	50	3 x CLZ-FP-46/33,3	115	0.48	241	305x255x155	31,00
400 Vac, 50 Hz, f resonance = 134 Hz / p= 14%									
RZ-5-400-14%	[C] P731100000300	5	50	CLZ-FP-52/7,5-HD CFB-52/7,5	7,2	16.31	62	180x195x100	6,00
RZ-10-400-14%	[C] P731150000300	10	50	CLZ-FP-52/15-HD CFB-52/15	15	8.15	91	250x245x130	16,00
RZ-12,5-400-14%	[C] P731170000300	12.5	50	CLZ-FP-52/20-HD CFB-52/19	18	6.52	130	250x245x130	16,00
RZ-15-400-14%	[C] P731200000300	15	50	CLZ-FP-52/25-HD CFB-52/23	22	5.43	130	250x245x145	20,00
RZ-20-400-14%	[C] P731250000300	20	50	CLZ-FP-52/30-HD CFB-52/30	29	4.07	150	250x245x145	21,00
RBZ-30-400-14%	[C] P731350000300	30	50	CLZ-FP-52/25-HD + CLZ-FP-52/20-HD CFB-52/46	43	2.71	191	300x255x155	36,00
RBZ-40-400-14%	[C] P731400000300	40	50	2 x CLZ-FP-52/30-HD CFB-52/60,5	58	2.03	267	345x255x155	40,00
RBZ-50-400-14%	[C] P731450000300	50	50	3 x CLZ-FP-52/25-HD CFB-52/76	72	1.63	341	345x275x175	52,00
RBZ-60-400-14%	[C] P731500000300	60	50	3 x CLZ-FP-52/30-HD CFB-52/91	87	1.35	421	375x275x185	61,00



RZ-RBZ-60Hz, Reactors III for detuned filters, 60 Hz

Type	Code	480 V kvar	Hz	For capacitor	In (A)	L(mH)	weight (kg)
480 Vac, 60 Hz, f resonance = 227 Hz / p= 7%							
RZ-7,5-480-60 Hz-7%	[C] P731130017000	7.5	60	CLZ-FP-52/8,5-60Hz-HD	9	6.12	4,00
RZ-10-480-60Hz-7%	[C] P731150017000	10	60	CLZ-FP-52/11,5-60Hz-HD	12	4.58	5,00
RZ-12,5-480-60 Hz-7%	[C] P731170017000	12.5	60	CLZ-FP-52/15-60Hz-HD	14	3.66	6,00
RZ-15-480-60 Hz-7%	[C] P731200017000	15	60	CLZ-FP-52/17-60Hz-HD	18	3.06	7,00
RBZ-20-480-60Hz-7%	[C] P731250017000	20	60	CLZ-FP-52/22,5-60Hz-HD	24	2.29	15,00
RBZ-25-480-60 Hz-7%	[C] P731300017000	25	60	CLZ-FP-52/30-60Hz-HD	30	1.83	18,00
RBZ-30-480-60 Hz-7%	[C] P731350017000	30	60	CLZ-FP-52/34-60Hz-HD	36	1.53	18,00
RBZ-40-480-60Hz-7%	[C] P731400017000	40	60	2 x CLZ-FP-52/22,5-60Hz-HD	48	1.15	20,00
RBZ-50-480-60 Hz-7%	[C] P731450017000	50	60	2 x CLZ-FP-52/30 -60Hz-HD	60	0.92	24,00
RBZ-60-480-60 Hz-7%	[C] P731500017000	60	60	2 x CLZ-FP-52/34-60Hz-HD	72	0.76	25,00
RBZ-80-480-60Hz-7%	[C] P731550017000	80	60	3 x CLZ-FP-52/30-60Hz-HD	96	0.58	35,00
480 Vac, 60 Hz, f resonance = 160 Hz / p= 14%							
RZ-12,5-480-60Hz-14%	[C] P731170017300	12.5	60	CLZ-FP-60/17,5-60Hz-HD	14	7.81	16,00
RZ-15-480-60Hz-14%	[C] P731200017300	15	60	CLZ-FP-60/21-60Hz-HD	18	6.52	16,00
RBZ-25-480-60Hz-14%	[C] P731300017300	25	60	CLZ-FP-60/34,5-60Hz-HD	30	3.91	26,00
RBZ-30-480-60Hz-14%	[C] P731350017300	30	60	2 x CLZ-FP-60/21-60Hz-HD	36	3.26	41,00
RBZ-50-480-60Hz-14%	[C] P731450017300	50	60	2 x CLZ-FP-60/34,5-60Hz-HD	60	1.95	51,00

TABLE OF ADDITIONAL FEATURES

RZ, RBZ		P	7	X	X	X	X	0	0	X	X	X
Code	Internal code									↑	↑	↑
Frequency	Standard (50 Hz)									0		-
	60 Hz									1		C
Voltage	Standard (400 V _{ca})									0		-
	230 V _{ca}									1		C
	Other voltages									C		C
Factor P %	Standard (7 %)									0		-
	5,67 %									4		C
	8,7 %									6		C
	14 %									3		C

Delivery time: [*] Immediate, [x] working weeks, [c] Consult



CFB-6B Power capacitors for harmonics filters with static switching operation of the FRE series

Capacitors with 6 terminals for CPCb boards. f resonance = 189 Hz

Type	Code	400 V kvar	440 V kvar	For reactor	Size (mm) width x height x depth	weight (kg)
400 Vac						
CFB-46/6-6B	[C] R2425A.	5	6.25	REZ-5-400	360x330x120	3,30
CFB-46/12,5-6B	[C] R2425D.	10	12.5	REZ-10-400	360x330x120	3,90
CFB-46/19-6B	[C] R2425E.	15	18.5	REZ-15-400	360x330x120	3,90
CFB-46/25-6B	[C] R2425G.	20	25	REZ-20-400	360x330x120	7,10
CFB-46/30-6B	[C] R2425H.	25	30	REZ-25-400	360x330x120	4,60
CFB-46/37-6B	[C] R2425J.	30	40	REZ-30-400	360x330x120	7,10
CFB-46/50-6B	[C] R2425K.	40	50	REZ-40-400	360x520x120	10,70
CFB-46/62-6B	[C] R2425L.	50	60	RBEZ-50-400	360x520x120	11,00
CFB-46/74-6B	[C] R2425P.	60	75	RBEZ-60-400	360x520x120	13,00
CFB-46/100-6B	[C] R2425R.	80	100	RBEZ-80-400	360x610x120	16,30

NOTE: The capacitor has been sized for 460/260 V and a power that is 20 % higher than that indicated in kvar columns to compensate for the overvoltage effect of the reactor.



REZ-RBEZ Reactors III for detuned static filters for FRE static switching bank

For capacitors with 6 terminals

Type	Code	400 V kvar	Hz	For capacitor	In (A)	L(mH)	Losses (W)	Size (mm) width x height x depth	weight (kg)
400 V, 50 Hz, f resonance = 189 Hz / p= 7%									
REZ-5-400	[4] P73210.	5	50	CFB-46/6-6B	5 A	23.67	63	90x155x150	4,00
REZ-10-400	[4] P73215.	10	50	CFB-46/12,5-6B	9 A	11.27	69	110x195x180	7,00
REZ-15-400	[4] P73220.	15	50	CFB-46/19-6B	13 A	7.5	70	120x195x180	9,00
REZ-20-400	[4] P73225.	20	50	CFB-46/25-6B	17 A	5.68	91	130x245x250	15,00
REZ-25-400	[4] P73230.	25	50	CFB-46/30-6B	21 A	4.68	110	130x245x250	16,00
REZ-30-400	[4] P73235.	30	50	CFB-46/37-6B	26 A	3.84	109	130x245x250	17,00
RBEZ-40-400	[4] P73240.	40	50	CFB-46/50-6B	35 A	2.84	179	180x235x300	30,00
RBEZ-50-400	[4] P73245.	50	50	CFB-46/62-6B	42 A	2.29	189	180x235x300	30,00
RBEZ-60-400	[4] P73250.	60	50	CFB-46/74-6B	51 A	1.89	252	180x235x300	30,00
RBEZ-80-400	[4] P73255.	80	50	CFB-46/100-6B	68 A	1.42	263	195x255x345	40,00

Supplement selection table to adapt CSB / CFB capacitor height to a capacitor bank equipped with CS / CF capacitors

CS / CF Capacitor TO REPLACE		CSB / CFB capacitor			
Total capacitor height (box + terminals) (mm)	Height box capacitor (mm)	Total height of capacitor (box+terminals) (mm)	Capacitor box height (mm)		
390	330	330	270	SP-60	[*] R2ZZZ1
610	550	520	460	SP-90	[*] R2ZZZ2
760	700	610	550	SP-150	[*] R2ZZZ3

TABLE OF ADDITIONAL FEATURES

REZ, RBEZ

P	7	X	X	X	X	0	0	X	X	X
Code	Internal code							Delivery time		
Frequency	Standard (50 Hz)							0	-	
	60 Hz							1	C	
Voltage	Standard (400 V _{ca})							0	-	
	230 V _{ca}							1	C	
	Other voltages							C	C	
Factor P %	Standard (7 %)							0	-	
	5,67 %							4	C	
	8,7 %							6	C	
	14 %							3	C	

Basic fixed compensation

**CLP-C**, CLZ Capacitor with miniature circuit breaker and contactor, 50 Hz

Type	Code	440 V kvar	Hz	In (A)	Cut off power	IP	Size (mm) width x height x depth	weight (kg)
440 Vac / 50Hz								
CLP-C-44/3	[C] R22575.	3	50	3.94	6 kA	20	215x490x147	1,20
CLP-C-44/5	[C] R22578.	5	50	6.57	6 kA	20	215x490x147	1,20
CLP-C-44/6,25	[C] R22579.	6.25	50	8.21	6 kA	20	215x490x147	1,20
CLP-C-44/7,5	[C] R2257A.	7.5	50	9.85	6 kA	20	215x490x147	1,20
CLP-C-44/10	[C] R2257C.	10	50	13	6 kA	20	215x490x147	1,20
CLP-C-44/12,5	[C] R2257D.	12.5	50	16	6 kA	20	215x490x147	1,20
CLP-C-44/15	[C] R2257E.	15	50	20	6 kA	20	215x490x147	5,00
CLP-C-44/20	[C] R2257F.	20	50	26	6 kA	20	215x490x147	5,00
CLP-C-44/25	[C] R2257G.	25	50	33	6 kA	20	215x490x147	1,20

**CSB-M** Power capacitors with miniature circuit breaker protection, 50 Hz

Type	Code	400 V kvar	440 V kvar	Cut off power	Aut.Switch (A)	Cable section (mm2)	Size (mm) width x height x depth	weight (kg)
440 Vac, 50 Hz								
CSB-M-5-440	[1] R23948.	4	5	6 kA	10	6	140x381x280	5,50
CSB-M-7,5-440	[1] R2394A.	6	7.5	6 kA	16	6	140x381x280	6,00
CSB-M-10-440	[1] R2394C.	8	10	6 kA	20	6	140x381x280	6,00
CSB-M-12,5-440	[*] R2394D.	10	12.5	6 kA	25	6	140x381x280	6,20
CSB-M-15-440	[1] R2394E.	12.5	15	6 kA	32	6	140x381x280	4,90
CSB-M-20-440	[*] R2394F.	17	20	6 kA	40	10	140x381x280	7,20
CSB-M-25-440	[*] R2394G.	21	25	6 kA	50	10	140x381x280	6,90
CSB-M-30-440	[*] R2394H.	25	30	6 kA	63	16	140x381x280	6,80
CSB-M-37,5-440	[*] R2394J.	31	37.5	10 kA	80	25	140x381x280	8,10
CSB-M-50-440	[*] R2394K.	42	50	10 kA	100	25	140x381x280	9,80
CSB-M-60-440	[*] R2394L.	50	60	10 kA	125	35	140x571x280	9,00
CSB-M-75-440	[*] R2394M.	66	75	10 kA	160	50	140x571x280	13,00

**CSB-F** Power capacitors with fuse protection, 50 Hz.

Type	Code	400 V kvar	440 V kvar	Cut off power	Fuses (A)	Cable section (mm2)	Size (mm) width x height x depth	weight (kg)
440 V, 50 Hz								
CSB-F-5-440	[1] R23958.	4	5	120 kA	16	6	140x381x280	7,00
CSB-F-12,5-440	[1] R2395D.	10	12.5	120 kA	35	6	140x381x280	8,10
CSB-F-15-440	[1] R2395E.	12.5	15	120 kA	50	6	140x381x280	8,30
CSB-F-20-440	[1] R2395F.	17	20	120 kA	50	10	140x381x280	8,00
CSB-F-25-440	[1] R2395G.	21	25	120 kA	50	10	140x381x280	8,00
CSB-F-30-440	[1] R2395H.	25	30	120 kA	80	16	140x381x280	8,00
CSB-F-37,5-440	[1] R2395J.	31	37.5	120 kA	100	25	140x381x280	9,22
CSB-F-50-440	[1] R2395K.	42	50	120 kA	125	25	140x381x280	10,00
CSB-F-60-440	[1] R2395L.	50	60	120 kA	160	35	140x571x280	10,00
CSB-F-75-440	[1] R2395P.	63	75	120 kA	160	50	140x571x280	13,00

Advanced fixed compensation



CCF CSB capacitor with contactor and fuses, 50 Hz

Type	Code	400 V kvar	440 V kvar	In (A)	Cut off power	Fuses (A)	Cable section (mm2)	Size (mm) width x height x depth	weight (kg)
440 V / 50 Hz									
CCF-12,5-440	[1] R3SA21.	10	12,5	16	120 kA	35	6	360x814x196	12,00
CCF-15-440	[1] R3SA31.	12,5	15	20	120 kA	35	10	360x814x196	13,00
CCF-20-440	[1] R3SA41.	17	20	26	120 kA	50	10	360x814x196	14,00
CCF-25-440	[1] R3SA51.	21	25	33	120 kA	63	10	360x814x196	15,00
CCF-30-440	[1] R3SA61.	25	30	39	120 kA	80	16	360x814x196	15,00
CCF-37,5-440	[1] R3SA81.	31	37,5	49	120 kA	80	25	360x814x196	17,00
CCF-50-440	[1] R3SA91.	42	50	66	120 kA	125	35	360x814x196	21,00
CCF-60-440	[1] R3SAA1.	50	60	79	120 kA	160	50	360x1004x196	22,00
CCF-75-440	[1] R3SAB1.	63	75	99	120 kA	160	50	360x1004x196	24,00
CCF-100-440	[1] R3SAD1.	80	100	131	120 kA	160	70	360x1004x196	29,00

Cable cross-section for installations with Un= 400 V. The installation company must ensure compliance with the low voltage directive at all times, in accordance with the particularities of each installation and type of cable



CPA Fixed capacitors with automatic 50-Hz switch protection

Type	Code	400 V kvar	440 V kvar	Cut off power	Aut.Switch (A)	Cable section (mm2)	Size (mm) width x height x depth	weight (kg)
CPA-15-440	[2] R24A3D.	12,5	15	50 kA	63	16	360x814x196	10,00
CPA-25-440	[2] R24A3H.	21	25	50 kA	63	16	360x814x196	16,00
CPA-37,5-440	[2] R24A3G.	31	37,5	50 kA	80	25	360x814x196	13,00
CPA-50-440	[2] R24A3J.	42	50	50 kA	100	25	360x814x196	15,00
CPA-60-440	[2] R24A3K.	50	60	50 kA	125	35	360x814x196	18,00
CPA-75-440	[2] R24A3L.	62	75	50 kA	160	50	360x1004x196	21,00
CPA-100-440	[2] R24A3M.	83	100	50 kA	200	70	360x1004x196	22,00
CPA-120-440	[2] R24A3N.	100	120	50 kA	250	95	360x1004x196	28,00

Cable cross-section for installations with Un= 400 V. The installation company must ensure compliance with the low voltage directive at all times, in accordance with the particularities of each installation and type of cable



OPTIM FRF Fixed capacitors with detuned reactor of P = 7% (fres=189 Hz), 50 Hz

Mounted on a metal cabinet. Floor mounted

Type	Code	400 V kvar	440 V kvar	Cable section (mm2)	Size (mm) width x height x depth	weight (kg)
OPTIM FRF, fuse protection APR, 440 V, 50 Hz						
OPTIM FRF-25-440	[2] R5X350.	21	25	10	650x1060x420	78,00
OPTIM FRF-37,5-440	[2] R5X370.	31	37,5	16	650x1060x420	82,00
OPTIM FRF-50-440	[2] R5X380.	42	50	25	650x1060x420	85,00
OPTIM FRF-60-440	[2] R5X390.	50	60	35	650x1060x420	90,00
OPTIM FRF-75-440	[2] R5X3A0.	62	75	50	650x1060x420	96,00
OPTIM FRF-100-440	[2] R5X3B0.	83	100	70	650x1060x420	110,00

See CFB capacitor and RZ /RBZ reactor components in the Low Voltage Capacitor and Reactor Section. Cable cross-section for installations with Un= 400 V. The installation company must ensure compliance with the low voltage directive at all times, in accordance with the particularities of each installation and type of cable



OPTIM FRM Fixed capacitors with detuned reactor of P = 7% (fres=189 Hz), 50 Hz

Mounted on a metal cabinet. Floor mounted

Type	Code	400 V kvar	440 V kvar	Cut off power	Cable section (mm2)	Size (mm) width x height x depth	weight (kg)
OPTIM FRM, molded case circuit breaker protection, 440 V, 50 Hz							
OPTIM FRM-25-440	[2] R5Y350.	21	25	50 kA	10	650x1060x420	78,00
OPTIM FRM-37,5-440	[2] R5Y370.	31	37,5	50 kA	16	650x1060x420	82,00
OPTIM FRM-50-440	[2] R5Y380.	42	50	50 kA	25	650x1060x420	85,00
OPTIM FRM-60-440	[2] R5Y390.	50	60	50 kA	35	650x1060x420	90,00
OPTIM FRM-75-440	[2] R5Y3A0.	62	75	50 kA	50	650x1060x420	96,00
OPTIM FRM-100-440	[2] R5Y3B0.	83	100	50 kA	70	650x1060x420	110,00

See CFB capacitor and RZ /RBZ reactor components in the Low Voltage Capacitor and Reactor Section. Cable cross-section for installations with Un= 400 V. The installation company must ensure compliance with the low voltage directive at all times, in accordance with the particularities of each installation and type of cable

Dimensions

CSB / CFB

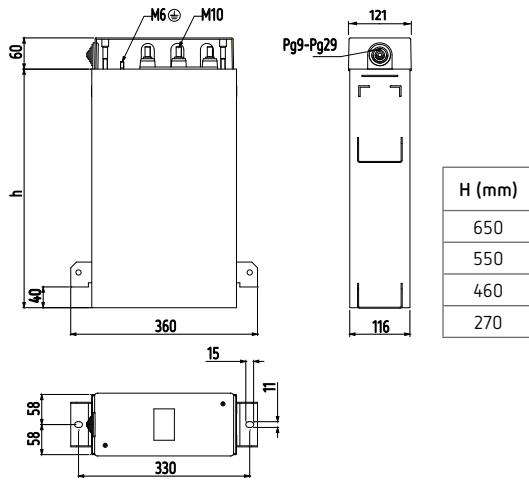

CLZ-FP

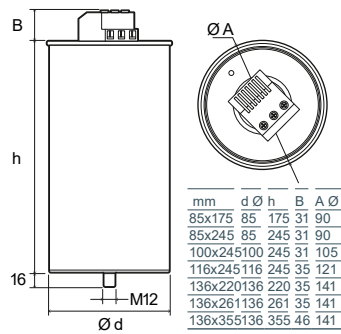

CLZ-FPT

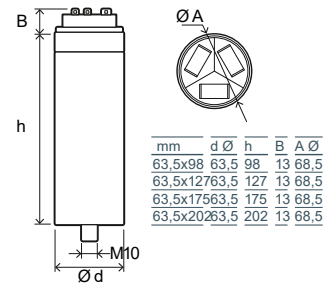

CSB-F / CSB-M

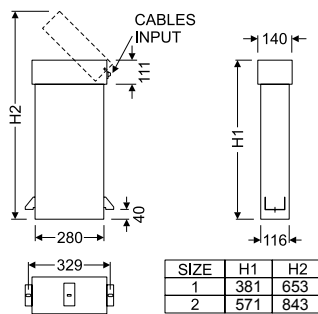

CPA

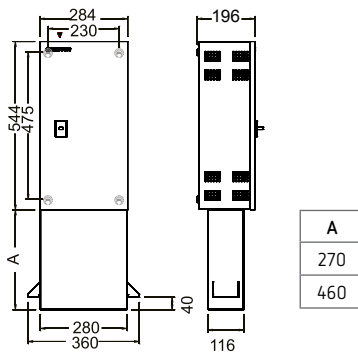

CCF

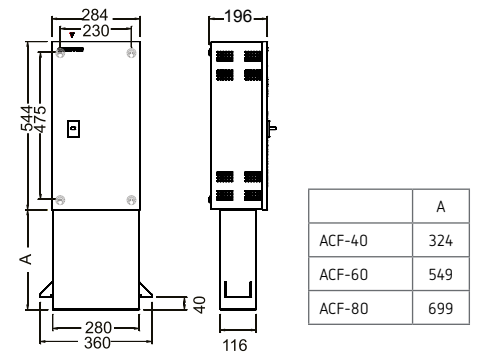

OPTIM FRF / OPTIM FRM

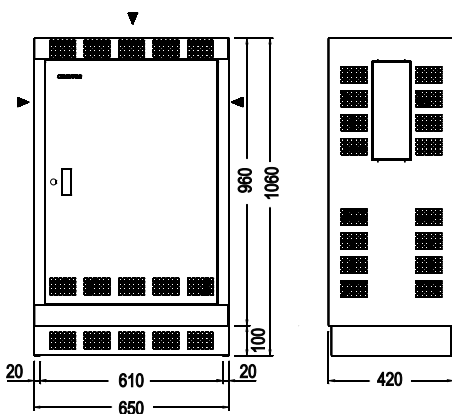

Dimensions

RZ / REZ

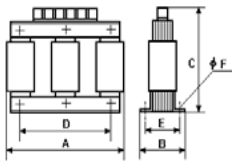

RBZ / RBEZ

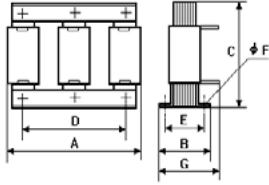

Type	A mm	B mm	C mm	D* mm	E* mm	F mm	G mm	kg
RZ-5-400	155	76	165	75	55	7	--	4
RZ-6,24-400	180	112	190	90	75	7	--	6
RZ-10-400	180	112	190	90	75	7	--	6,5
RZ-12,5-400	180	112	190	90	85	7	--	7
RZ-15-400	180	110	190	90	85	7	--	8
RBZ-20-400	235	125	165	150	95	7	145	14
RBZ-25-400	235	125	165	150	95	7	145	14
RBZ-30-400	255	125	200	160	95	9	150	19
RBZ-40-400	255	125	200	160	95	9	150	20
RBZ-50-400	255	145	220	160	115	9	175	25
RBZ-60-400	255	145	240	180	115	9	175	28
RBZ-80-400	305	155	255	180	115	11	190	31

Type	A mm	B mm	C mm	D* mm	E* mm	F mm	G mm	kg
REZ-05-400	150	90	155	75	70	7	-	4
REZ-10-400	180	110	195	90	83	7	-	7
REZ-15-400	180	120	195	90	93	7	-	9
REZ-20-400	250	130	245	130	98	7	-	15
REZ-25-400	250	130	245	130	98	7	-	16
REZ-30-400	250	130	245	130	98	7	-	17
RBEZ-40-400	300	145	235	160	113	9	180	30
RBEZ-50-400	300	145	235	160	113	9	180	30
RBEZ-60-400	300	145	235	160	113	9	180	30
RBEZ-80-400	345	155	255	180	121	11	195	40

* Distance between fixings

Low voltage capacitor banks

Table: Selection of the reactive energy compensation unit

Multiple loads	Slow variations	Without harmonics	OPTIM P&P	
		With harmonics	SVGm / OPTIM SVGm	Inmunity to harmonics
			OPTIM FR P&P	Elimination of resonances
	Fast variations	Without harmonics	OPTIM EMK	
		With harmonics	SVGm	Inmunity to harmonics
			OPTIM FRE	Elimination of resonances

Table: Selection of the OPTIM

OPTIM 3 P&P / 5 P&P

OPTIM 9 P&P / 8 P&P

OPTIM 8L / 14L / 16L



Rated voltage		440 V		440 V		440 V
Service voltage		400 V		400 V		400 V
Power range at rated voltage		OPTIM 3: 12,5 ... 62,5 kvar OPTIM 5: 55 ... 150 kvar		OPTIM 9: 165 ... 270 kvar OPTIM 8: 300 ... 480 kvar		OPTIM 8L: 450 a 800 kvar OPTIM 14L: 900 a 1400 kvar OPTIM 16L: 1500 a 1600 kvar
Contactor switching		•		•		•
No. Steps (maximum)		3 / 5		9 / 8		8 / 14 / 16
Enclosure	Thermoplastic IP 21	–		–		–
	Metallic IP 21	•		•		•
Installation (indoor)		•		•		•
Assembly	Wall-mounted	•		–		–
	Floor-mounted	–		•		•
Regulator	computer C Wi-Fi	•		•		•
	computer Smart III		Optional		Optional	
Capacitor	Cylindrical CLZ	•		•		•
Built-in protection	General miniature circuit breaker		OPTIM 3: General OPTIM 5: By step	–		–
	APR NH-00 Fuses	–		•		•
Autotransformer for aux. supply		–		•		•

Table: Recommended capacitor bank power ratings - 7.5 to 105 kvar

kvar	Recommended capacitor bank	Electrical steps (kvar)
7,5 ... 17,5 kvar	OPTIM 3-P&P-17,5-440	7 x 2,5
17,5 ... 31,25 kvar	OPTIM 3-P&P-31,25-440	5 x 6,25
31,25 ... 43,75 kvar	OPTIM 3-P&P-43,75-440	7 x 6,25
43,75 ... 55 kvar	OPTIM 5-P&P-55-440	11 x 5
55 ... 70 kvar	OPTIM 5-P&P-70-440	7 x 10
75 ... 105 kvar	OPTIM 5-P&P-105-440	15 + 3 x 30





OPTIM P&P Automatic capacitor banks, 2.5 to 1600 kvar, 50 Hz.

Type	Code	400 V kvar	440 V kvar	Composition	Aut.Switch (A)	Man. Switch (A)	Cable section (mm ²)	Size (mm) width x height x depth	weight (kg)
OPTIM 3 P&P, automatic capacitor banks with computer C Wi-Fi regulator									
OPTIM 3 P&P-12,5-440	[*] R3L110.	10	12.5	2,5+5+5	Included	-	6	400x600x260	18,00
OPTIM 3 P&P-17,5-440	[*] R3L120.	14	17.5	2,5+5+10	Included	-	6	400x600x260	18,00
OPTIM 3 P&P-25-440	[*] R3L130.	20	25	5+10+10	Included	-	10	400x600x260	18,00
OPTIM 3 P&P-31,25-440	[*] R3L140.	26	31.25	6,25+12,5+12,5	Included	-	10	400x600x260	18,00
OPTIM 3 P&P-37,5-440	[*] R3L150.	31.25	37.5	7,5+15+15	Included	-	16	400x600x260	18,00
OPTIM 3 P&P-43,75-440	[*] R3L160.	36	43.75	6,25+12,5+25	Included	-	25	400x600x260	18,00
OPTIM 3 P&P-52,5-440	[1] R3L170.	43	52.5	7,5+15+30	Included	-	25	400x600x260	20,00
OPTIM 3 P&P-62,5-440	[1] R3L180.	51	62.5	12,5+25+25	Included	-	35	400x600x260	40,00
OPTIM 5 P&P, automatic capacitor banks with computer C Wi-Fi regulator									
OPTIM 5 P&P-55-440	[*] R3L210.	45	55	5+10+20+20	125	200	35	600x740x260	31,00
OPTIM 5 P&P-70-440	[*] R3L220.	58	70	10+3x20	125	200	50	600x740x260	31,00
OPTIM 5 P&P-90-440	[1] R3L230.	74	90	15+15+30+30	200	200	70	600x740x260	31,00
OPTIM 5 P&P-105-440	[*] R3L240.	87	105	15+30+30+30	200	200	70	600x740x260	31,00
OPTIM 5 P&P-135-440	[1] R3L250.	112	135	15+30+30+30+30	250	250	95	600x740x260	37,00
OPTIM 5 P&P-150-440	[1] R3L260.	124	150	30+30+30+30+30	250	250	95	600x740x260	39,00
OPTIM 9 P&P, automatic capacitor banks with computer C Wi-Fi regulator. Built-in power supply autotransformer									
OPTIM 9 P&P-165-440	[*] R3L310.	136	165	15+5x30	400	400	120	700x1350x440	80,00
OPTIM 9 P&P-195-440	[1] R3L320.	161	195	15+6x30	400	400	150	700x1350x440	85,00
OPTIM 9 P&P-225-440	[*] R3L330.	186	225	15+7x30	400	400	185	700x1350x440	86,00
OPTIM 9 P&P-255-440	[1] R3L340.	211	255	15+8x30	630	630	240	700x1350x440	98,00
OPTIM 9 P&P-270-440	[1] R3L350.	223	270	9x30	630	630	240	700x1350x440	100,00
OPTIM 8 P&P, automatic capacitor banks with computer C Wi-Fi regulator. Built-in power supply autotransformer									
OPTIM 8 P&P-300-440	[1] R3L410.	248	300	2x30+4x60	630	630	2x150	1000x1750x440	126,00
OPTIM 8 P&P-330-440	[1] R3L420.	273	330	30+5x60	630	630	2x150	1000x1750x440	128,00
OPTIM 8 P&P-390-440	[1] R3L430.	322	390	30+6x60	800	800	2x185	1000x1750x440	135,00
OPTIM 8 P&P-450-440	[1] R3L440.	372	450	30+7x60	800	800	2x240	1000x1750x440	142,00
OPTIM 8 P&P-480-440	[1] R3L450.	396	480	8x60	1000	1000	2x240	1000x1750x440	163,00
OPTIM 8L P&P, automatic capacitor banks with computer C Wi-Fi regulator. Built-in power supply autotransformer									
OPTIM 8L P&P-550-440	[1] R35L10.	454	550	50+5x100	1000	1000	2x240	1200x1900x650	234,00
OPTIM 8L P&P-650-440	[1] R35L20.	537	650	50+6x100	1250	1250	3x150	1200x1900x650	255,00
OPTIM 8L P&P-750-440	[1] R35L30.	620	750	50+7x100	1600	1600	3x185	1200x1900x650	280,00
OPTIM 8L P&P-800-440	[1] R35L40.	661	800	8x100	1600	1600	3x185	1200x1900x650	290,00
OPTIM 14L P&P, automatic capacitor banks with computer C Wi-Fi regulator. Built-in power supply autotransformer									
OPTIM 14L P&P-900-440	[2] R36L10.	743	900	2X50+8x100	1250+400	1250+400	3x150/185	2100x1900x650	435,00
OPTIM 14L P&P-950-440	[2] R36L20.	785	950	50+9x100	1600+400	1600+400	3x185/185	2100x1900x650	445,00
OPTIM 14L P&P-1050-440	[2] R36L30.	867	1050	50+10x100	1600+630	1600+630	3x185/240	2100x1900x650	470,00
OPTIM 14L P&P-1150-440	[2] R36L40.	950	1150	50+11x100	1600+800	1600+800	3x185/2x150	2100x1900x650	495,00
OPTIM 14L P&P-1200-440	[2] R36L50.	991	1200	12x100	1600+800	1600+800	3x185/2x185	2100x1900x650	505,00
OPTIM 14L P&P-1300-440	[2] R36L60.	1074	1300	100+6x200	1600+1000	1600+1000	3x185/2x240	2100x1900x650	535,00
OPTIM 14L P&P-1400-440	[2] R36L70.	1156	1400	100+100+6x200	1600+1000	1600+1000	3x185/3x120	2100x1900x650	560,00
OPTIM 16L P&P, automatic capacitor banks with computer C Wi-Fi regulator. Built-in power supply autotransformer									
OPTIM 16L P&P-1500-440	[2] R37L30.	1239	1500	100+7x200	1600+1250	1600+1250	3x185/3x150	2400x1900x650	583,00
OPTIM 16L P&P-1600-440	[2] R37L40.	1322	1600	100+100+7x200	1600+1600	1600+1600	3x185/3x185	2400x1900x650	580,00

Cable cross-section for installations with Un= 400 V. The installation company must ensure compliance with the low voltage directive at all times, in accordance with the characteristics of each installation and type of cable.

All batteries with computer C Wi-Fi regulator come with charge VAR system

Table: selection capacitor banks with rejection filters, Type P=7% ($f_{res}=189$ Hz), 50 Hz

		OPTIM FRS P&P	OPTIM FR P&P
			
Rated voltage		440 V	440 V
Service voltage		400 V	400 V
Power range at rated voltage (50 Hz)		de 31,25 a 120 kvar	OPTIM FR4 P&P: 150 a 400 kvar OPTIM FR6 P&P: 400 a 600 kvar OPTIM FR8 P&P: 600 a 800 kvar OPTIM FR10 P&P: 800 a 1000 kvar OPTIM FR12 P&P: 1050 a 1200 kvar
Contacting switching		•	•
No. Steps (maximum)		4	4 / 6 / 8 / 10 / 12
Enclosure	Metallic IP 21	•	•
Installation (indoor)		•	•
Assembly (floor-mounted)		•	•
Regulator	Computer C Wi-Fi	•	•
	Computer Smart III		Optional
Capacitor	Cylindrical CLZ	•	•
Reactors tuned to 189 Hz (ask if you require other tuning values)		•	•
Built-in protection	Miniature circuit breaker per step	•	–
	APR NH-00 Fuses	–	•
Autotransformer for aux. supply		•	•



OPTIM FR P&P Automatic capacitor banks with detuned filters (contactors switching), type P=7% (fres=189 Hz), 50 Hz.

Type	Code	400 V kvar	440 V kvar	Composition	Aut.Switch (A)	Man. Switch (A)	Cable section (mm ²)	Size (mm) width x height x depth	weight (kg)
OPTIM FRS-P&P, automatic capacitor banks with computer C Wi-Fi regulator									
OPTIM FRS-P&P-31,25-440	[2] R54R64.	26	31.25	6,25 + 2 x 12,5	-	Included	10	800x1200x500	82,00
OPTIM FRS-P&P-43,75-440	[2] R54R74.	36	43.75	6,25 + 12,5 + 25	-	Included	25	800x1200x500	108,00
OPTIM FRS-P&P-62,5-440	[2] R54R81.	52	62.5	12,5 + 2 x 25	-	Included	35	800x1200x500	100,00
OPTIM FRS-P&P-90-440	[2] R54R88.	74	90	2 x 15 + 2 x 30	-	Included	70	800x1200x500	133,00
OPTIM FRS-P&P-105-440	[2] R54R92.	87	105	15 + 3 x 30	-	Included	70	800x1200x500	122,00
OPTIM FRS-P&P-120-440	[2] R54R95.	99	120	4 x 30	-	Included	95	800x1200x500	129,00
OPTIM FR4-P&P, automatic capacitor banks with computer C Wi-Fi regulator									
OPTIM FR4-P&P-150-440	[2] R54S24.	125	150	30 + 2 x 60	400	400	95	900x1900x650	220,00
OPTIM FR4-P&P-175-440	[2] R54S25.	145	175	25 + 50 + 100	400	400	120	900x1900x650	225,00
OPTIM FR4-P&P-200-440	[2] R54S28.	165	200	50 + 50 + 100	400	400	150	900x1900x650	209,00
OPTIM FR4-P&P-250-440	[2] R54S29.	207	250	50 + 2 x 100	630	630	185	900x1900x650	242,00
OPTIM FR4-P&P-300-440	[2] R54S30.	248	300	50 + 50 + 2 x 100	630	630	240	900x1900x650	270,00
OPTIM FR4-P&P-350-440	[2] R54S32.	289	350	50 + 3 x 100	630	630	2x150	900x1900x650	299,00
OPTIM FR4-P&P-400-440	[2] R54S34.	331	400	4 x 100	800	800	2x185	900x1900x650	335,00
OPTIM FR6-P&P, automatic capacitor banks with computer C Wi-Fi regulator									
OPTIM FR6-P&P-400-440	[2] R54T25.	331	400	50 + 50 + 3 x 100	800	800	2x185	1200x1900x650	370,00
OPTIM FR6-P&P-450-440	[2] R54T30.	372	450	50 + 4 x 100	800	800	2x185	1200x1900x650	376,00
OPTIM FR6-P&P-500-440	[2] R54T35.	413	500	5 x 100	1000	1000	2x240	1200x1900x650	397,00
OPTIM FR6-P&P-550-440	[2] R54T40.	455	550	50 + 5 x 100	1000	1000	2x240	1200x1900x650	465,00
OPTIM FR6-P&P-600-440	[2] R54T45.	496	600	6 x 100	1000	1000	2x240	1200x1900x650	685,00
OPTIM FR8-P&P, automatic capacitor banks with computer C Wi-Fi regulator									
OPTIM FR8-P&P-600-440	[2] R54U36.	496	600	50 + 50 + 5 x 100	1250	1250	2x240	1500x1900x650	525,00
OPTIM FR8-P&P-650-440	[2] R54U38.	537	650	50 + 6 x 100	1250	1250	3x150	1500x1900x650	504,00
OPTIM FR8-P&P-700-440	[2] R54U40.	579	700	7 x 100	1250	1250	3x150	1500x1900x650	555,00
OPTIM FR8-P&P-750-440	[2] R54U42.	620	750	50 + 7 x 100	1600	1600	3x185	1500x1900x650	580,00
OPTIM FR8-P&P-800-440	[2] R54U44.	661	800	8 x 100	1600	1600	3x185	1500x1900x650	582,00
OPTIM FR10-P&P, automatic capacitor banks with computer C Wi-Fi regulator									
OPTIM FR10-P&P-800-440	[2] R54V25.	661	800	8 x 100	1000+400	1000+400	2x240/ 240	2100x1900x650	695,00
OPTIM FR10-P&P-850-440	[2] R54V30.	702	850	50 + 8 x 100	1000+630	1000+630	2x240/ 240	2100x1900x650	735,00
OPTIM FR10-P&P-900-440	[2] R54V35.	744	900	9 x 100	1000+630	1000+630	2x240/ 240	2100x1900x650	775,00
OPTIM FR10-P&P-950-440	[2] R54V40.	785	950	50 + 9 x 100	1000+800	1000+800	2x240/ 2x185	2100x1900x650	800,00
OPTIM FR10-P&P-1000-440	[2] R54V45.	826	1000	10 x 100	1000+800	1000+800	2x240/ 2x185	2100x1900x650	825,00
OPTIM FR12-P&P, automatic capacitor banks with computer C Wi-Fi regulator									
OPTIM FR12-P&P-1050-440	[2] R54W50.	868	1050	50 + 10 x 100	1000+1000	1000+1000	2x240/ 2x240	2400x1900x650	890,00
OPTIM FR12-P&P-1100-440	[2] R54W55.	909	1100	11 x 100	1000+1000	1000+1000	2x240/ 2x240	2400x1900x650	930,00
OPTIM FR12-P&P-1150-440	[2] R54W60.	950	1150	50 + 11 x 100	2x1000	2x1000	2x240/ 2x240	2400x1900x650	947,00
OPTIM FR12-P&P-1200-440	[2] R54W65.	992	1200	12 x 100	2x1000	2x1000	2x240/ 2x240	2400x1900x650	980,00

Cable cross-section for installations with Un= 400 V. The installation company must ensure compliance with the low voltage directive at all times, in accordance with the characteristics of each installation and type of cable. All batteries with computer C Wi-Fi regulator come with charge VAR system

TABLE OF ADDITIONAL FEATURES

OPTIM P&P												
R	3	X	X	X	X	0	0	X	X	X		
Code	Internal code							↑	↑	↑	Delivery time	
Options	Standard	0							↑	↑	↑	-
	Autotransformer for aux. supply	1							↑	↑	↑	-
	Fan	2							↑	↑	↑	-
	Polycarbonate	3							↑	↑	↑	-
	Autotransf. + Fan	4							↑	↑	↑	- OPTIM 3 & 5 P&P
	Autotransf. + Polycarbonate	5							↑	↑	↑	- OPTIM 3 & 5 P&P
	Polycarbonate + Fan	6							↑	↑	↑	-
	Autotransf. + Polycarbonate + Fan	7							↑	↑	↑	- OPTIM 3 & 5 P&P
Regulator	Standard	0							↑	↑	↑	-
	computer SMART III 6	S							↑	↑	↑	-
	computer SMART III 12	T							↑	↑	↑	-
	computer SMART III 14	Z							↑	↑	↑	-
	computer SMART III 12 +SmartLink VAR	L							↑	↑	↑	- No OPTIM 3
Switch	without switch	0							↑	↑	↑	-
	Manual switch 200 A	3							↑	↑	↑	-
	Manual switch 250A	4							↑	↑	↑	-
	Manual switch 400 A	5							↑	↑	↑	-
	Manual switch 630 A	6							↑	↑	↑	-
	Manual switch 800 A	7							↑	↑	↑	-
	Manual switch 1000 A	8							↑	↑	↑	-
	Manual switch 1250 A	Y							↑	↑	↑	-
	Manual switch 1600 A	9							↑	↑	↑	-
	Circuit breaker 63 A	A							↑	↑	↑	-
	Circuit breaker 125 A	B							↑	↑	↑	-
	Circuit breaker 160 A / 200 A	C							↑	↑	↑	-
	Circuit breaker 250A	D							↑	↑	↑	-
	Circuit breaker 400 A	E							↑	↑	↑	-
	Circuit breaker 630 A	F							↑	↑	↑	-
	Circuit breaker 800 A	G							↑	↑	↑	-
	Circuit breaker 1000 A	H							↑	↑	↑	-
	Circuit breaker 1250 A	I							↑	↑	↑	-
	Circuit breaker 1600 A	J							↑	↑	↑	-
	Circuit breaker 63 A + Residual current	K							↑	↑	↑	-
	Circuit breaker 125 A + Residual current	L							↑	↑	↑	-
	Circuit breaker 160 A + Residual current	M							↑	↑	↑	-
	Circuit breaker 250 A + Residual current	N							↑	↑	↑	-
	Circuit breaker 400 A + Residual current	O							↑	↑	↑	-
Circuit breaker 630 A + Residual current	P							↑	↑	↑	-	
Circuit breaker 800 A + Residual current	Q							↑	↑	↑	-	
Circuit breaker 1000 A + Residual current	R							↑	↑	↑	-	
Circuit breaker 1250 A + Residual current	S							↑	↑	↑	-	
Circuit breaker 1600 A + Residual current	T							↑	↑	↑	-	

OPTIM FRS P&P / OPTIM FR P&P												
R	5	X	X	X	X	0	0	X	X	X		
Code	Internal code							↑	↑	↑	Delivery time	
Options	Standard	0							↑	↑	↑	-
	Fan	2							↑	↑	↑	-
	Polycarbonate	3							↑	↑	↑	-
	Polycarbonate + Fan	6							↑	↑	↑	-
Regulator	Standard	0							↑	↑	↑	-
	computer SMART III 6	S							↑	↑	↑	-
	computer SMART III 12	T							↑	↑	↑	-
	computer SMART III 14	Z							↑	↑	↑	-
	computer SMART III 12 +SmartLink VAR	L							↑	↑	↑	-
	without switch	0							↑	↑	↑	-
	Manual switch 200 A	3							↑	↑	↑	-
	Manual switch 250A	4							↑	↑	↑	-
	Manual switch 400 A	5							↑	↑	↑	-
	Manual switch 630 A	6							↑	↑	↑	-
Manual switch 800 A	7							↑	↑	↑	-	
Manual switch 1000 A	8							↑	↑	↑	-	
Manual switch 1250 A	Y							↑	↑	↑	-	
Manual switch 1600 A	9							↑	↑	↑	-	
Switch	Circuit breaker 63 A	A							↑	↑	↑	-
	Circuit breaker 125 A	B							↑	↑	↑	-
	Circuit breaker 160 A / 200 A	C							↑	↑	↑	-
	Circuit breaker 250A	D							↑	↑	↑	-
	Circuit breaker 400 A	E							↑	↑	↑	-
	Circuit breaker 630 A	F							↑	↑	↑	-
	Circuit breaker 800 A	G							↑	↑	↑	-
	Circuit breaker 1000 A	H							↑	↑	↑	-
	Circuit breaker 1250 A	I							↑	↑	↑	-
	Circuit breaker 1600 A	J							↑	↑	↑	-
	Circuit breaker 63 A + Residual current	K							↑	↑	↑	-
	Circuit breaker 125 A + Residual current	L							↑	↑	↑	-
	Circuit breaker 160 A + Residual current	M							↑	↑	↑	-
	Circuit breaker 250 A + Residual current	N							↑	↑	↑	-
Circuit breaker 400 A + Residual current	O							↑	↑	↑	-	
Circuit breaker 630 A + Residual current	P							↑	↑	↑	-	
Circuit breaker 800 A + Residual current	Q							↑	↑	↑	-	
Circuit breaker 1000 A + Residual current	R							↑	↑	↑	-	
Circuit breaker 1250 A + Residual current	S							↑	↑	↑	-	
Circuit breaker 1600 A + Residual current	T							↑	↑	↑	-	



OPTIM-SVGm Combined automatic capacitor banks

Type	Code	400 V kvar	440 V kvar	Composition	Frequency (Hz)	Size (mm) width x height x depth	weight (kg)
50 Hz							
OPTIM SVGm-200-440	[3] RG20F1.	182	200	1 x 100 kvar + 100 kvar	50 Hz	627x1959x804	261,00
OPTIM SVGm-300-440	[3] RG20F3.	264	300	2 x 100 kvar + 100 kvar	50 Hz	627x1959x804	305,00
OPTIM SVGm-400-440	[3] RG20F5.	346	400	3 x 100 kvar + 100 kvar	50 Hz	627x1959x804	349,00
OPTIM SVGm-500-440	[3] RG20F7.	428	500	4 x 100 kvar + 100 kvar	50 Hz	1254x1959x804	598,00
OPTIM SVGm-600-440	[3] RG20F9.	510	600	5 x 100 kvar + 100 kvar	50 Hz	1254x1959x804	642,00
OPTIM SVGm-700-440	[3] RG20FB.	592	700	6 x 100 kvar + 100 kvar	50 Hz	1254x1959x804	686,00
OPTIM SVGm-800-440	[3] RG20FD.	674	800	7 x 100 kvar + 100 kvar	50 Hz	1254x1959x804	730,00



OPTIM-SVGm-60Hz Combined automatic capacitor banks, 60 Hz

Type	Code	480 V kvar	Composition	Frequency (Hz)	Size (mm) width x height x depth	weight (kg)
60 Hz						
OPTIM SVGm-175-480-60Hz	[C] RG26F1.	175	1 x 75 kvar + 100 kvar	60 Hz	627x1959x804	250,00
OPTIM SVGm-250-480-60Hz	[C] RG26F3.	250	2 x 75 kvar + 100 kvar	60 Hz	627x1959x804	310,00
OPTIM SVGm-325-480-60Hz	[C] RG26F5.	325	3 x 75 kvar + 100 kvar	60 Hz	627x1959x804	370,00
OPTIM SVGm-400-480-60Hz	[C] RG26F7.	400	4 x 75 kvar + 100 kvar	60 Hz	1254x1959x804	555,00
OPTIM SVGm-475-480-60Hz	[C] RG26F9.	475	5 x 75 kvar + 100 kvar	60 Hz	1254x1959x804	615,00
OPTIM SVGm-550-480-60Hz	[C] RG26FB.	550	6 x 75 kvar + 100 kvar	60 Hz	1254x1959x804	675,00
OPTIM SVGm-625-480-60Hz	[C] RG26FD.	625	7 x 75 kvar + 100 kvar	60 Hz	1254x1959x804	735,00



SVGm, Static Var Generator with multilevel technology, 50 / 60 Hz.

Type	Code	System	230 V kvar	400 V kvar	440 V kvar	480 V kvar	500 V kvar	690 V kvar	Phase current	Size (mm) width x height x depth	weight (kg)
3 wires 480 V, Wall-mounted cabinet											
SVGm-3WF-30M-480	[2] R4P3M0.	3 wires, 230...480 V	17.4	30	30	30	-	-	44	430x530x178	21,00
SVGm-3WF-075M-480	[2] R4P3M6.	3 wires, 230...480 V	43.1	75	75	75	-	-	110	439x745x288	56,00
SVGm-3WF-100M-480	[2] R4P3M2.	3 wires, 230...480 V	57.5	100	100	100	-	-	145	439x745x288	56,00
3 wires 480 V, Floor-mounted cabinet											
SVGm-3WF-100C-480	[2] R4P3F2.	3 wires, 230...480 V	57.5	100	100	100	-	-	145	608x1890x812	190,00
SVGm-3WF-200C-480	[2] R4P3F3.	3 wires, 230...480 V	115	200	200	200	-	-	290	608x1890x812	245,00
SVGm-3WF-300C-480	[2] R4P3F4.	3 wires, 230...480 V	172.5	300	300	300	-	-	435	608x1890x812	300,00
SVGm-3WF-400C-480	[2] R4P3F5.	3 wires, 230...480 V	230	400	400	400	-	-	580	608x1890x812	355,00
3 wires 690 V, Floor-mounted cabinet											
SVGm-3WF-100C-690	[3] R4P5F2.	3 wires, 500 ... 690 V	-	-	-	-	72	100	84	608x1890x812	192,00
SVGm-3WF-200C-690	[3] R4P5F3.	3 wires, 500 ... 690 V	-	-	-	-	144	200	168	608x1890x812	249,00
SVGm-3WF-300C-690	[3] R4P5F4.	3 wires, 500 ... 690 V	-	-	-	-	216	300	252	608x1890x812	306,00
SVGm-3WF-400C-690	[3] R4P5F5.	3 wires, 500 ... 690 V	-	-	-	-	288	400	336	608x1890x812	363,00
4 wires 400 V, Wall-mounted cabinet											
SVGm-4WF-020M-400	[2] R4P4MA.	4 wires, 230...400 V	12	20.7	-	-	-	-	30	430x530x178	21,00
SVGm-4WF-050M-400	[2] R4P4ML.	4 wires, 230...400 V	30	51.7	-	-	-	-	75	439x745x288	56,00
SVGm-4WF-069M-400	[2] R4P4MC.	4 wires, 230...400 V	40	69	-	-	-	-	100	439x745x288	56,00
4 wires 400 V, Floor-mounted cabinet											
SVGm-4WF-069C-400	[2] R4P4FC.	4 wires, 230...400 V	40	69	-	-	-	-	100	608x1890x812	190,00
SVGm-4WF-138C-400	[2] R4P4FD.	4 wires, 230...400 V	80	138	-	-	-	-	200	608x1890x812	245,00
SVGm-4WF-207C-400	[2] R4P4FE.	4 wires, 230...400 V	119.1	207	-	-	-	-	300	608x1890x812	300,00
SVGm-4WF-276C-400	[2] R4P4FF.	4 wires, 230...400 V	159	276	-	-	-	-	400	608x1890x812	355,00
4 wires 550 V, Floor-mounted cabinet											
SVGm-4WF-067C-550	[3] R4P6FG.	4 wires, 440 ... 550 V	-	-	53	58	-	-	70	608x1890x812	192,00
SVGm-4WF-134C-550	[3] R4P6FH.	4 wires, 440 ... 550 V	-	-	106	116	-	-	140	608x1890x812	249,00
SVGm-4WF-201C-550	[3] R4P6FJ.	4 wires, 440 ... 550 V	-	-	159	174	-	-	210	608x1890x812	306,00
SVGm-4WF-268C-550	[3] R4P6FK.	4 wires, 440 ... 550 V	-	-	212	232	-	-	280	608x1890x812	363,00

All equipment has built-in EMI filters

TABLE OF ADDITIONAL FEATURES

SVGm	
R	4 P X X X 0 0 X X 0
Code	Internal code
Protection degree	Standard IP-20
	IP-41
	IP-54



OPTIM EMK Automatic capacitor banks with static contactor, 50 Hz.

Type	Code	400 V kvar	440 V kvar	Composition	Aut.Switch (A)	Man. Switch (A)	Cable section (mm ²)	Size (mm) width x height x depth	weight (kg)
OPTIM EMK4									
OPTIM EMK4-175-440	[2] R46420.	147	175	25 + 50 + 100	400	400	120	900x1900x650	170,00
OPTIM EMK4-250-440	[2] R46422.	207	250	50 + 2x100	630	630	185	900x1900x650	183,00
OPTIM EMK4-300-440	[2] R46424.	248	300	50 + 50 + 2x100	630	630	240	900x1900x650	208,00
OPTIM EMK4-350-440	[2] R46425.	289	350	50 + 3x100	630	630	2x150	900x1900x650	203,00
OPTIM EMK4-400-440	[2] R46426.	331	400	4x100	800	800	2x185	900x1900x650	231,00
OPTIM EMK6									
OPTIM EMK6-400-440	[2] R46431.	331	400	50 + 50 + 3x100	800	800	2x185	1200x1900x650	262,00
OPTIM EMK6-450-440	[2] R46435.	372	450	50 + 4x100	800	800	2x185	1200x1900x650	281,00
OPTIM EMK6-550-440	[2] R46437.	455	550	50 + 5x100	1000	1000	2x240	1200x1900x650	320,00
OPTIM EMK6-600-440	[2] R46438.	496	600	6x100	1000	1000	2x240	1200x1900x650	334,00
OPTIM EMK8									
OPTIM EMK8-600-440	[2] R46442.	496	600	50 + 50 + 5x100	1250	1250	2x240	1500x1900x650	365,00
OPTIM EMK8-650-440	[2] R46444.	537	650	50 + 6x100	1250	1250	3x150	1500x1900x650	384,00
OPTIM EMK8-750-440	[2] R46450.	620	750	50 + 7x100	1600	1600	3x185	1500x1900x650	359,00
OPTIM EMK8-800-440	[2] R46455.	661	800	8x100	1600	1600	2x240 / 240	1500x1900x650	373,00
OPTIM EMK10									
OPTIM EMK10-850-440	[2] R46505.	702	850	50 + 8x100	1000+630	1000+630	2x240 / 240	2100x1900x650	512,00
OPTIM EMK10-950-440	[2] R46604.	785	950	50 + 9x100	1000+800	1000+800	2x240 / 2x185	2100x1900x650	551,00
OPTIM EMK10-1000-440	[2] R46605.	826	1000	10x100	1000+800	1000+800	2x240 / 2x185	2100x1900x650	565,00
OPTIM EMK12									
OPTIM EMK12-1050-440	[2] R46606.	868	1050	50 + 10x100	1000+800	1000+800	2x240 / 2x240	2400x1900x650	615,00
OPTIM EMK12-1150-440	[2] R46608.	950	1150	50 + 11x100	2x1000	2x1000	2x240 / 2x240	2400x1900x650	654,00
OPTIM EMK12-1200-440	[2] R46609.	992	1200	12x100	2x1000	2x1000	2x240 / 2x240	2400x1900x650	668,00

Cable cross-section for installations with Un= 400 V. The installation company must ensure compliance with the low voltage directive at all times, in accordance with the characteristics of each installation and type of cable.



CPC3 Zero-crossing control board (for EMF / EMB modules)

Type	Code	Vac	Control	Size (mm) width x height x depth	weight (kg)
CPCb-230/400	[1] R4Z111.	230 / 400	Three-phase	230x110x40	0,62



EMB-2PH, Three-phase static switching units for 3-terminal capacitors

Type	Code	230 V kvar	400 V kvar	Size (mm) width x height x depth	weight (kg)
EMB-M-2PH-80-400	[1] R4132M.	45	80	165x220x250	4,00

Maximum operating voltage: 3 x 440 Vac (415 Vac with detuned reactors) Polycarbonate cover for EMB-2PH

Table: Selection of Static automatic capacitor banks with rejection filters

		OPTIM FRE
		
Rated voltage		440 V
Service voltage		400 V
Power range at rated voltage (50 Hz)		OPTIM FRE4: 150 ... 400 kvar OPTIM FRE6: 400 ... 600 kvar OPTIM FRE8: 600 ... 800 kvar OPTIM FRE10: 800 ... 1000 kvar OPTIM FRE12: 1050 ... 1200 kvar
Thyristor operation		•
No. Steps (maximum)		4 / 6 / 8 / 10 / 12
Enclosure	Metallic IP 21	•
Installation (indoor)		•
Assembly (floor-mounted)		•
Regulator	Computer Max F-12DC	–
	Computer Smart Fast III-12DC	Included
Capacitor		Cylindrical CLZ
Reactors tuned to 189 Hz (please ask about other tuning values)		•
Built-in protection	circuit breaker per step	–
	APR NH-00 Fuses	•



OPTIM FRE Automatic capacitor banks with rejection filters (static contactor), 50 Hz. Optional installation of a mains switch, f resonance =189 Hz

Type	Code	400 V kvar	440 V kvar	Composition	Aut.Switch (A)	Man. Switch (A)	Cable section (mm ²)	Size (mm) width x height x depth	weight (kg)
FRE4									
OPTIM FRE4-150-440	[2] R64E24.	125	150	30 + 2 x 60	400	400	95	900x1900x650	220,00
OPTIM FRE4-175-440	[2] R64E25.	145	175	25 + 50 + 100	400	400	120	900x1900x650	225,00
OPTIM FRE4-200-440	[2] R64E28.	165	200	50 + 50 + 100	400	400	150	900x1900x650	235,00
OPTIM FRE4-250-440	[2] R64E29.	207	250	50 + 2 x 100	630	630	185	900x1900x650	250,00
OPTIM FRE4-300-440	[2] R64E30.	248	300	50 + 50 + 2 x 100	630	630	240	900x1900x650	290,00
OPTIM FRE4-350-440	[2] R64E32.	289	350	50 + 3 x 100	630	630	2x150	900x1900x650	310,00
OPTIM FRE4-400-440	[2] R64E34.	331	400	4 x 100	800	800	2x185	900x1900x650	318,00
FRE6									
OPTIM FRE6-400-440	[2] R64J25.	331	400	50 + 50 + 3 x 100	800	800	2x185	1200x1900x650	370,00
OPTIM FRE6-450-440	[2] R64J30.	372	450	50 + 4 x 100	800	800	2x185	1200x1900x650	376,00
OPTIM FRE6-500-440	[2] R64J35.	413	500	5 x 100	1000	1000	2x240	1200x1900x650	440,00
OPTIM FRE6-550-440	[2] R64J40.	455	550	50 + 5 x 100	1000	1000	2x240	1200x1900x650	465,00
OPTIM FRE6-600-440	[2] R64J45.	496	600	6 x 100	1000	1000	2x240	1200x1900x650	490,00
FRE8									
OPTIM FRE8-600-440	[2] R64K36.	496	600	50 + 50 + 5 x 100	1250	1250	2x240	1500x1900x650	525,00
OPTIM FRE8-650-440	[2] R64K38.	537	650	50 + 6 x 100	1250	1250	3x150	1500x1900x650	540,00
OPTIM FRE8-700-440	[2] R64K40.	579	700	7 x 100	1250	1250	3x150	1500x1900x650	555,00
OPTIM FRE8-750-440	[2] R64K42.	620	750	50 + 7 x 100	1600	1600	3x185	1500x1900x650	580,00
OPTIM FRE8-800-440	[2] R64K44.	661	800	8 x 100	1600	1600	3x185	1500x1900x650	605,00
FRE10									
OPTIM FRE10-800-440	[2] R64C25.	661	800	8 x 100	1000+400	1000+400	2x240 / 240	2100x1900x650	695,00
OPTIM FRE10-850-440	[2] R64C30.	702	850	50 + 8 x 100	1000+630	1000+630	2x240 / 240	2100x1900x650	735,00
OPTIM FRE10-900-440	[2] R64C35.	744	900	9 x 100	1000+630	1000+630	2x240 / 240	2100x1900x650	775,00
OPTIM FRE10-950-440	[2] R64C40.	785	950	50 + 9 x 100	1000+800	1000+800	2x240 / 2x185	2100x1900x650	800,00
OPTIM FRE10-1000-440	[2] R64C45.	826	1000	10 x 100	1000+800	1000+800	2x240 / 2x185	2100x1900x650	825,00
FRE12									
OPTIM FRE12-1050-440	[2] R64L50.	868	1050	50 + 10 x 100	1000+1000	1000+1000	2x240 / 2x240	2400x1900x650	890,00
OPTIM FRE12-1100-440	[2] R64L55.	909	1100	11 x 100	1000+1000	1000+1000	2x240 / 2x240	2400x1900x650	930,00
OPTIM FRE12-1150-440	[2] R64L60.	950	1150	50 + 11 x 100	2x1000	2x1000	2x240 / 2x240	2400x1900x650	955,00
OPTIM FRE12-1200-440	[2] R64L65.	992	1200	12 x 100	2x1000	2x1000	2x240 / 2x240	2400x1900x650	980,00

Cable cross-section for installations with Un= 400 V. The installation company must ensure compliance with the low voltage directive at all times, in accordance with the characteristics of each installation and type of cable.

TABLE OF ADDITIONAL FEATURES

OPTIM EMK, OPTIM FRE

OPTIM EMK, OPTIM FRE												
R	X	X	X	X	X	0	0	X	X	X		
Code	Internal Code							↑	↑	↑	Delivery time	
Options	Standard	0							↑	↑	↑	-
	Fan	2										-
	Polycarbonate	3										-
	Polycarbonate + Fan	6										-
Choose the most suitable regulator for your needs	Standard	0							↑	↑	↑	-
	computer Smart III f-12Vdc	9										-
	computer Smart III f-12Vdc	D										-
Switch	Without switch	0							↑	↑	↑	-
	Manual switch 200 A	3										-
	Manual switch 250A	4										-
	Manual switch 400 A	5										-
	Manual switch 630 A	6										-
	Manual switch 800 A	7										-
	Manual switch 1000 A	8										-
	Manual switch 1250 A	Y										-
	Manual switch 1600 A	9										-
	Circuit breaker 63 A	A										-
	Circuit breaker 125 A	B										-
	Circuit breaker 160 / 200 A	C										-
	Circuit breaker 250A	D										-
	Circuit breaker 400 A	E										-
	Circuit breaker 630 A	F										-
	Circuit breaker 800 A	G										-
	Circuit breaker 1000 A	H										-
	Circuit breaker 1250 A	I										-
	Circuit breaker 1600 A	J										-
	Circuit breaker 63 A + Residual current	K										-
	Circuit breaker 125 A + Residual current	L										-
	Circuit breaker 160 / 200 A + Residual current	M										-
	Circuit breaker 250 A + Residual current	N										-
	Circuit breaker 400 A + Residual current	O										-
Circuit breaker 630 A + Residual current	P							-				
Circuit breaker 800 A + Residual current	Q							-				
Circuit breaker 1000 A + Residual current	R							-				
Circuit breaker 1250 A + Residual current	S							-				
Circuit breaker 1600 A + Residual current	T							-				

Dimensions

OPTIM 3 P&P

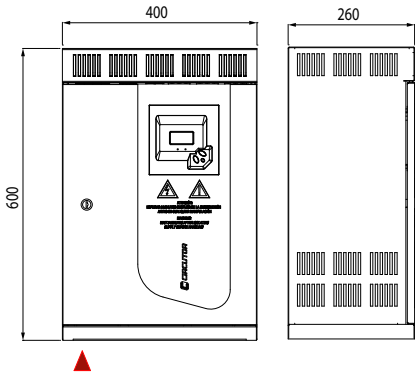

OPTIM 5 P&P

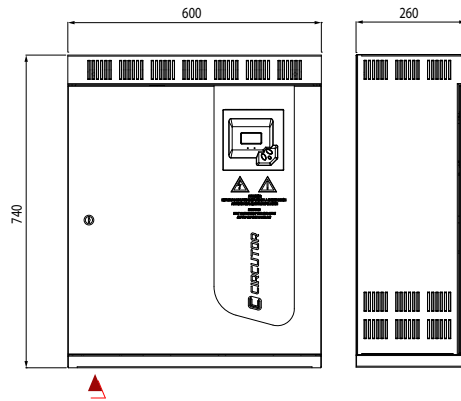

OPTIM 9 P&P

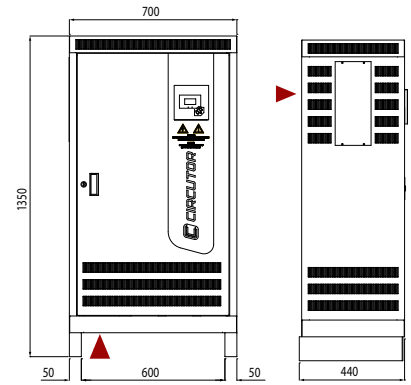

OPTIM 8

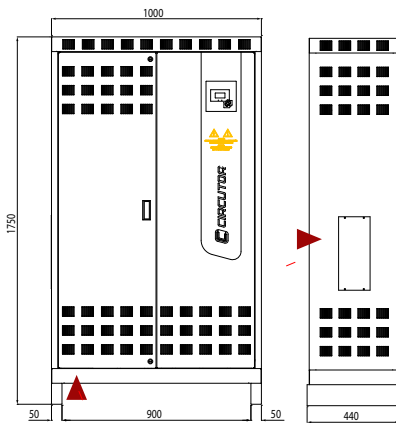

OPTIM 8L

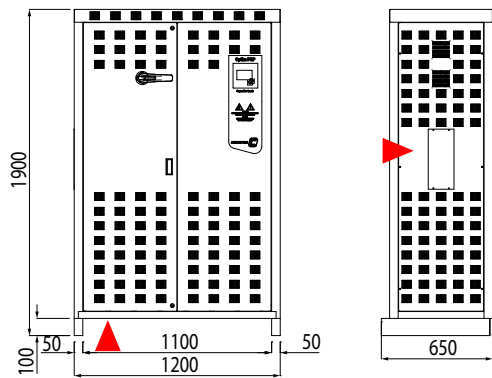

OPTIM 14L

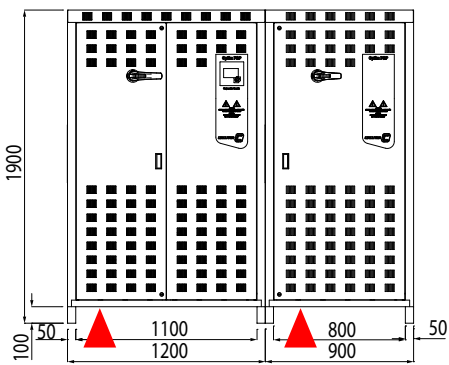

OPTIM 16L

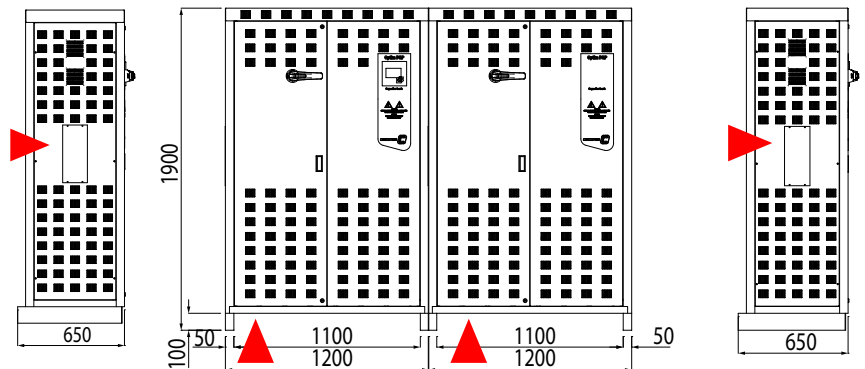

Dimensions

OPTIM FRS

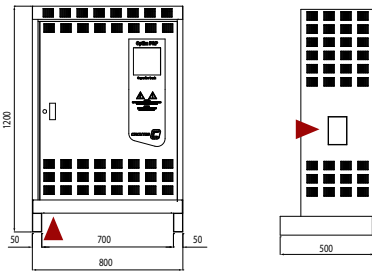

OPTIM EMK4 / OPTIM FR4 / OPTIM FRE4

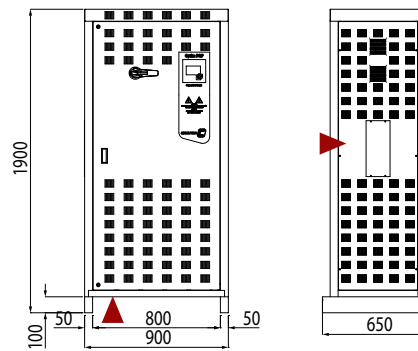

OPTIM EMK6 / OPTIM FR6 / OPTIM FRE6

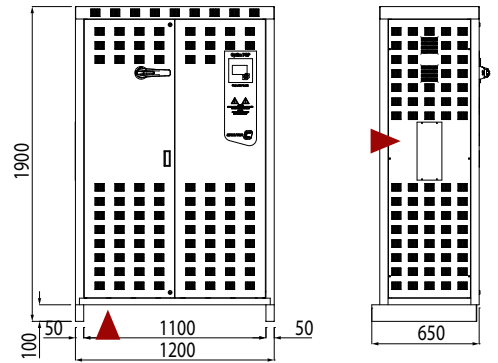

OPTIM EMK8 / OPTIM FR8 / OPTIM FRE8

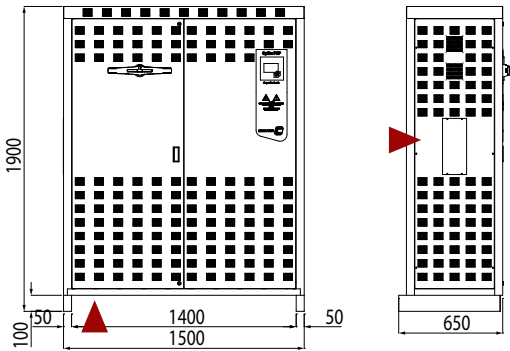

OPTIM FRF / OPTIM FRM

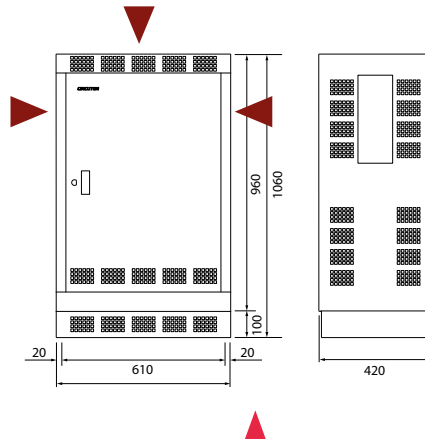

OPTIM EMK10 / OPTIM FR10 / OPTIM FRE10

OPTIM FR10 = OPTIM FR4 + OPTIM FR6. / Width: OPTIM FR4+ OPTIM FR6+100 mm

OPTIM EMK12 / OPTIM FR12 / OPTIM FRE12

OPTIM FR12 = 2 x OPTIM FR6. / Width= 2 x OPTIM FR6+100 mm

EMB-2PH

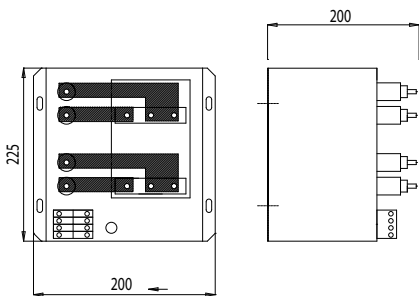

Harmonic filters

NEW



AFQs, Active multifunction filter

Type	Code	System	Phase current	Peak current	Max. neutral current	Size (mm) width x height x depth	weight (kg)
3 wires 480 V, Wall-mounted cabinet							
AFQs-3WF-030M	[C] R7MS0F.	3 wires, 208...480 V	30	60	-	205x490x201	13,00



AFQm, Active multifunction filter, 50 / 60 Hz

50/60 Hz - Harmonic filtering, phase balancing and power factor correction

Type	Code	System	Phase current	Peak current	Max. neutral current	Size (mm) width x height x depth	weight (kg)
3 wires 480 V, Wall-mounted cabinet							
AFQm-3WF-075M-480	[C] R7MMAF.	3 wires, 230...480 V	75	150	-	439x745x288	56,00
AFQm-3WF-100M-480	[C] R7MM2F.	3 wires, 230...480 V	100	200	-	439x745x288	56,00
3 wires 480 V, Floor-mounted cabinet							
AFQm-3WF-100C-480	[C] R7MF2F.	3 wires, 230...480 V	100	200	-	608x1890x812	190,00
AFQm-3WF-200C-480	[C] R7MF3F.	3 wires, 230...480 V	200	400	-	608x1890x812	245,00
AFQm-3WF-300C-480	[C] R7MF4F.	3 wires, 230...480 V	300	600	-	608x1890x812	300,00
AFQm-3WF-400C-480	[C] R7MF5F.	3 wires, 230...480 V	400	800	-	608x1890x812	355,00
3 wires 690 V, Floor-mounted cabinet							
AFQm-3WF-070C-690	[C] R7JF6F.	3 wires, 400...690 V	70	140	-	608x1890x812	192,00
AFQm-3WF-140C-690	[C] R7JF7F.	3 wires, 400...690 V	140	280	-	608x1890x812	249,00
AFQm-3WF-210C-690	[C] R7JF8F.	3 wires, 400...690 V	210	420	-	608x1890x812	306,00
AFQm-3WF-280C-690	[C] R7JF9F.	3 wires, 400...690 V	280	560	-	608x1890x812	363,00
4 wires 400 V, Wall-mounted cabinet							
AFQm-4WF-030M-400	[C] R7RM0F.	4 wires, 230...400 V	30	60	90	430x530x178	21,00
AFQm-4WF-075M-400	[C] R7RMAF.	4 wires, 230...400 V	75	150	225	439x745x288	56,00
AFQm-4WF-100M-400	[C] R7RM2F.	4 wires, 230...400 V	100	200	300	439x745x288	56,00
4 wires 400 V, Floor-mounted cabinet							
AFQm-4WF-100C-400	[C] R7RF2F.	4 wires, 230...400 V	100	200	300	608x1890x812	190,00
AFQm-4WF-200C-400	[C] R7RF3F.	4 wires, 230...400 V	200	400	600	608x1890x812	245,00
AFQm-4WF-300C-400	[C] R7RF4F.	4 wires, 230...400 V	300	600	900	608x1890x812	300,00
AFQm-4WF-400C-400	[C] R7RF5F.	4 wires, 230...400 V	400	800	1200	608x1890x812	355,00
4 wires 550 V, Floor-mounted cabinet							
AFQm-4WF-070C-550	[C] R7NF6F.	4 wires, 400...550 V	70	140	210	608x1890x812	192,00
AFQm-4WF-140C-550	[C] R7NF7F.	4 wires, 400...550 V	140	280	420	608x1890x812	249,00
AFQm-4WF-210C-550	[C] R7NF8F.	4 wires, 400...550 V	210	420	630	608x1890x812	306,00
AFQm-4WF-280C-550	[C] R7NF9F.	4 wires, 400...550 V	280	560	840	608x1890x812	363,00
Rack module							
AFQm-3WF-070R-690	[C] R7JR6F.	3 wires, 400...690 V	70	140	-	482.5x266x714.5	55,00
AFQm-4WF-070R-550	[C] R7NR6F.	4 wires, 400...550 V	70	140	210	482.5x266x714.5	55,00
AFQm-3WF-100R-480	[C] R7MR2F.	3 wires, 230...480 V	100	200	-	482.5x266x714.5	55,00

Please contact our technical department for networks with high THD(V) levels.
All equipment has built-in EMI filters

TABLE OF ADDITIONAL FEATURES

AFQm-xWF-xxxC										
R	7	P	X	X	X	0	0	X	X	0
Code									↑	Delivery time
Protection degree									0	-
									5	consult
									7	consult

New



LRZ / LRBZ, Filter reactors for power converters (network side), 50 Hz

Type	Code	In (A)	Motor P. (kW)	Motor P. (CV)	L(mH)	Losses (W)	Size (mm) width x height x depth	weight (kg)
LRZ 04-050	[2] P7330B.	47	22	30	0.67	64	180x197x110	9,10
LRZ 04-066	[2] P7330D.	64	30	41	0.49	88	180x197x120	11,00
LRBZ 04-080	[2] P7330E.	76	37	50	0.4	110	180x160x135	12,50
LRBZ 04-115	[2] P7330G.	110	55	75	0.28	145	237x195x131	21,00
LRBZ 04-185	[C] P7330J.	180	90	122	0.17	230	242x256x154	32,00
LRBZ 04-200	[C] P7330K.	200	110	150	0.15	245	245x256x154	27,00
LRBZ 04-300	[C] P7330M.	300	160	220	0.1	355	280x300x164	48,00



LCL, Harmonic filters for power converters

Type	Code	Q (kvar)	Load current (A)	Frequency (Hz)	Size (mm) width x height x depth	weight (kg)
400 V						
LC L35-76A-400	[4] R73114.	14,92	76	50	650x1060x420	-
LC L35-90A-400	[4] R73115.	18,24	90	50	800x1900x650	-
LC L35-110A-400	[4] R73116.	23,21	110	50	800x1900x650	-
LC L35-150A-400	[4] R73117.	29,84	150	50	800x1900x650	-
LC L35-180A-400	[4] R73118.	36,48	180	50	800x1900x650	-
LC L35-220A-400	[4] R73119.	46,42	220	50	800x1900x650	-
LC L35-260A-400	[4] R73120.	53,06	260	50	800x1900x650	-
LC L35-320A-400	[4] R73121.	66,32	320	50	1100x1900x650	-
LC L35-400A-400	[4] R73122.	79,58	400	50	1100x1900x650	-
460 - 480 V						
LC L36-9A-480	[4] R732050070000	2,73	9	60	365x570x217	-
LC L36-16A-480	[4] R732070070000	4,55	16	60	365x570x217	-
LC L36-22A-480	[4] R732080070000	6,21	22	60	460x930x230	-
LC L36-32A-480	[4] R732090070000	7,59	32	60	460x930x230	-
LC L36-40A-480	[4] R732100070000	11,38	40	60	460x930x230	-
LC L36-47A-480	[4] R732110070000	15,18	47	60	650x1060x420	-
LC L36-64A-480	[4] R732130070000	18,97	64	60	650x1060x420	-
LC L36-54A-480	[4] R732120070000	15,18	54	60	650x1060x420	-
LC L36-76A-480	[4] R732140070000	22,77	76	60	650x1060x420	-
LC L36-90A-480	[4] R732150070000	26,56	90	60	800x1900x650	-
LC L36-110A-480	[4] R732160070000	30,36	110	60	800x1900x650	-
LC L36-150A-480	[4] R732170070000	45,53	150	60	800x1900x650	-
LC L36-180A-480	[4] R732180070000	53,12	180	60	800x1900x650	-
LC L36-220A-480	[4] R732190070000	60,71	220	60	800x1900x650	-
LC L36-260A-480	[4] R732200070000	68,3	260	60	800x1900x650	-
LC L36-400A-480	[4] R732220070000	121,42	400	60	1100x1900x650	612,00

Please contact us for other current, frequency and/or voltage values Optional: Overcompensation kit

TABLE OF ADDITIONAL FEATURES

LRZ / LRBZ

P	7	X	X	X	X	0	0	X	X	X	
Code	Internal code							Delivery time			
	Standard (4 %)							0			-
Voltage drop	3 %							1			consult
	2 %							2			consult
Frequency	Estandard (50 Hz)							0			-
	60 Hz							1			consult
System	Standard (three-phase)							0			-
	Single-phase							1			consult

Delivery time: [*] Immediate, [x] working weeks, [c] Consult

Dimensions

AFQm-30 / SVGm-30

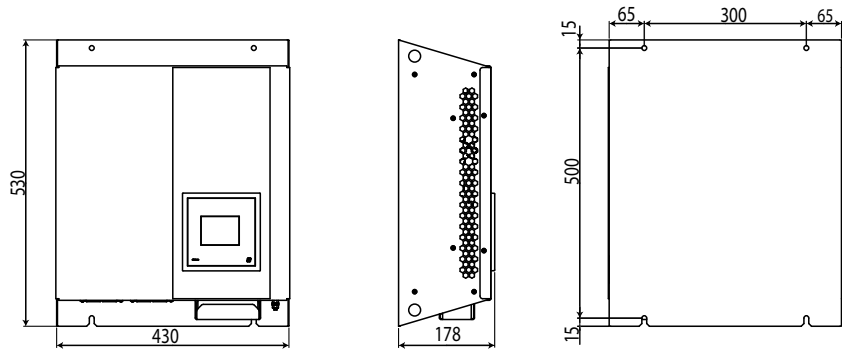

AFQm-75M / SVGm-75M
AFQm-100M / SVGm-100M

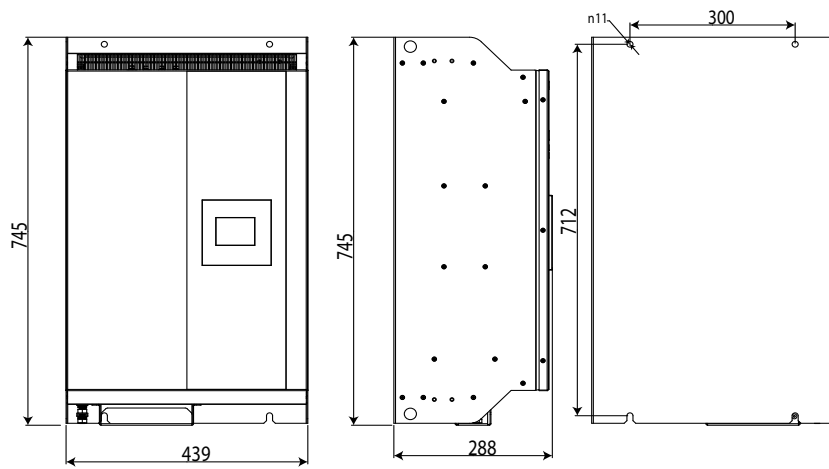

AFQm-100C // SVGm-100C
AFQm-200C / SVGm-200C
AFQm-300C / SVGm-300C
AFQm-400C / SVGm-400C

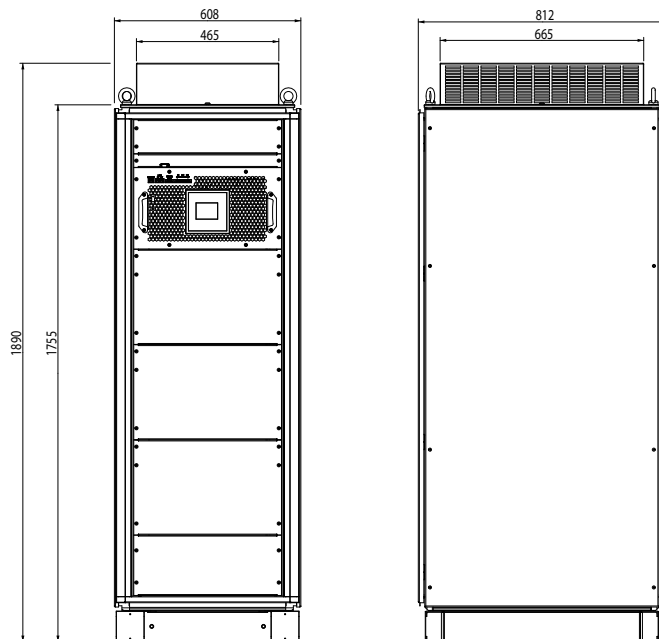

LRZ / LRBZ

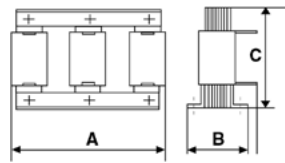
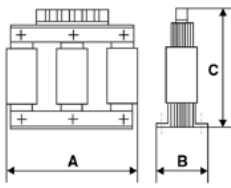

Type	A mm	B mm	C mm	kg
LRZ 04-003	120	60	125	1,8
LRZ 04-004	120	60	125	1,8
LRZ 04-006	120	60	125	2
LRZ 04-008	120	60	125	2
LRZ 04-010	120	70	125	2,3
LRZ 04-013	120	70	125	2,3
LRZ 04-017	150	75	150	3,5
LRZ 04-022	150	90	152	4,6
LRZ 04-033	150	90	152	5
LRZ 04-041	180	100	193	7,5
LRZ 04-050	180	110	197	9
LRZ 04-058	180	110	197	9,5
LRZ 04-066	180	120	197	11

Type	A mm	B mm	C mm	kg
LRBZ 04-080	180	135	160	13
LRBZ 04-095	237	120	195	18
LRBZ 04-115	237	131	195	21
LRBZ 04-150	237	131	215	26
LRBZ 04-185	242	154	256	32
LRBZ 04-200	245	154	256	36
LRBZ 04-250	285	154	300	44
LRBZ 04-300	280	164	300	48

Capacitor and MV accessories



10% surcharge for orders less than or equal to 3 units (per type)

The prices shown in the price list refer to capacitors for indoor/outdoor installation, with internal fuses (depending on type), 50 Hz, class C temperature and without pressure switch.

According to IEC 60871-1, IEC 60871-2 and IEC 60871-4 standards



CHV-T Three-phase MV power capacitors

Type	Code	Q (kvar)	Frequency (Hz)	Size (mm) width x height x depth	weight (kg)
BIL 20/60 kV (50 Hz) - 3,3 kV					
CHV-T 50/3,3	[C] R8K0500003305	50	50	350x422x160	18,80
CHV-T 75/3,3	[C] R8K0750003305	75	50	350x472x160	22,40
CHV-T 100/3,3	[C] R8K100000330E	100	50	350x472x160	22,80
CHV-T 150/3,3	[C] R8K150000330E	150	50	350x572x160	30,00
CHV-T 200/3,3	[C] R8K200000330E	200	50	350x632x160	34,40
CHV-T 250/3,3	[C] R8K250000330E	250	50	350x802x160	45,70
CHV-T 300/3,3	[C] R8K300000330E	300	50	350x802x160	46,70
CHV-T 333/3,3	[C] R8K333000330E	333	50	350x862x175	55,60
CHV-T 400/3,3	[C] R8K400000330E	400	50	350x892x175	58,30
CHV-T 500/3,3	[C] R8K500000330E	500	50	350x1032x175	69,40
BIL 20/60 kV (50 Hz) - 6,6 kV					
CHV-T 50/6,6	[C] R8K0500006605	50	50	350x422x160	19,20
CHV-T 75/6,6	[C] R8K0750006605	75	50	350x472x160	22,60
CHV-T 100/6,6	[C] R8K1000006605	100	50	350x472x160	23,00
CHV-T 150/6,6	[C] R8K1500006605	150	50	350x572x160	30,20
CHV-T 200/6,6	[C] R8K200000660E	200	50	350x632x160	38,30
CHV-T 250/6,6	[C] R8K250000660E	250	50	350x802x160	45,90
CHV-T 300/6,6	[C] R8K300000660E	300	50	350x802x160	46,90
CHV-T 333/6,6	[C] R8K333000660E	333	50	350x862x175	55,90
CHV-T 400/6,6	[C] R8K400000660E	400	50	350x892x175	58,60
CHV-T 500/6,6	[C] R8K500000660E	500	50	350x1032x175	69,70
CHV-T 600/6,6	[C] R8K600000660E	600	50	350x1182x175	81,20
CHV-T 750/6,6	[C] R8K750000660E	750	50	350x1252x200	97,60
BIL 28/75 kV (50 Hz) - 11 kV					
CHV-T 50/11	[C] R8L0500011005	50	50	350x422x160	19,30
CHV-T 75/11	[C] R8L0750011005	75	50	350x472x160	22,70
CHV-T 100/11	[C] R8L1000011005	100	50	350x472x160	23,00
CHV-T 150/11	[C] R8L1500011005	150	50	350x572x160	29,10
CHV-T 200/11	[C] R8L2000011005	200	50	350x632x160	34,40
CHV-T 250/11	[C] R8L2500011005	250	50	350x802x160	45,70
CHV-T 300/11	[C] R8L3000011005	300	50	350x802x160	46,50
CHV-T 333/11	[C] R8L3330011005	333	50	350x862x175	53,00
CHV-T 500/11	[C] R8L500001100E	500	50	350x1032x175	67,00
CHV-T 600/11	[C] R8L600001100E	600	50	350x1182x175	80,70
CHV-T 750/11	[C] R8L750001100E	750	50	350x1252x200	92,10

Codes R8xxxxxxx5 cannot have an internal fuse.



10% surcharge for orders less than or equal to 3 units (per type)
 The prices shown in the price list refer to capacitors for indoor/outdoor installation, with internal fuses (depending on type), 50 Hz, class C temperature and without pressure switch.
 According to IEC 60871-1, IEC 60871-2 and IEC 60871-4 standards



CHV-M Single-phase MV power capacitors (indoor and outdoor use)

Type	Code	Q (kvar)	Frequency (Hz)	Size (mm) width x height x depth	weight (kg)
BIL 20/60 kV (50 Hz) - 3,81 kV					
CHV-M 50/3,81	[C] R8A0500003815	50	50	350x487x160	18,20
CHV-M 75/3,81	[C] R8A075000381E	75	50	350x487x160	18,50
CHV-M 100/3,81	[C] R8A100000381E	100	50	350x537x160	21,90
CHV-M 150/3,81	[C] R8A150000381E	150	50	350x637x160	29,10
CHV-M 167/3,81	[C] R8A167000381E	167	50	350x637x160	29,30
CHV-M 200/3,81	[C] R8A200000381E	200	50	350x697x160	33,50
CHV-M 250/3,81	[C] R8A250000381E	250	50	350x867x160	44,80
CHV-M 300/3,81	[C] R8A300000381E	300	50	350x867x160	45,80
CHV-M 333/3,81	[C] R8A333000381E	333	50	350x957x160	52,30
CHV-M 400/3,81	[C] R8A400000381E	400	50	350x927x175	55,30
CHV-M 500/3,81	[C] R8A500000381E	500	50	350x1097x175	68,30
BIL 28/75 kV (50 Hz) - 6,35 kV					
CHV-M 50/6,35	[C] R8B0500006355	50	50	350x487x160	17,90
CHV-M 75/6,35	[C] R8B0750006355	75	50	350x537x160	21,80
CHV-M 100/6,35	[C] R8B1000006355	100	50	350x537x160	21,80
CHV-M 150/6,35	[C] R8B150000635E	150	50	350x637x160	28,60
CHV-M 167/6,35	[C] R8B167000635E	167	50	350x637x160	29,10
CHV-M 200/6,35	[C] R8B200000635E	200	50	350x697x160	33,20
CHV-M 250/6,35	[C] R8B250000635E	250	50	350x757x160	37,80
CHV-M 300/6,35	[C] R8B300000635E	300	50	350x867x160	45,30
CHV-M 333/6,35	[C] R8B333000635E	333	50	350x857x175	49,40
CHV-M 400/6,35	[C] R8B400000635E	400	50	350x927x175	54,50
CHV-M 500/6,35	[C] R8B500000635E	500	50	350x1067x175	65,60
CHV-M 600/6,35	[C] R8B600000635E	600	50	350x1247x175	79,20
CHV-M 750/6,35	[C] R8B750000635E	750	50	350x1217x200	90,40
BIL 38/95 kV (50 Hz) - 9,53 kV					
CHV-M 50/9,53	[C] R8C0500009535	50	50	350x530x160	19,50
CHV-M 75/9,53	[C] R8C0750009535	75	50	350x530x160	20,20
CHV-M 100/9,53	[C] R8C1000009535	100	50	350x580x160	23,60
CHV-M 150/9,53	[C] R8C1500009535	150	50	350x680x160	31,00
CHV-M 167/9,53	[C] R8C1670009535	167	50	350x740x160	34,90
CHV-M 200/9,53	[C] R8C2000009535	200	50	350x740x160	35,40
CHV-M 250/9,53	[C] R8C2500009535	250	50	350x910x160	46,90
CHV-M 300/9,53	[C] R8C300000953E	300	50	350x910x160	48,00
CHV-M 333/9,53	[C] R8C333000953E	333	50	350x1000x160	54,70
CHV-M 400/9,53	[C] R8C400000953E	400	50	350x1000x175	59,70
CHV-M 500/9,53	[C] R8C500000953E	500	50	350x1140x175	71,00
CHV-M 600/9,53	[C] R8C600000953E	600	50	350x1290x175	83,10
CHV-M 750/9,53	[C] R8C750000953E	750	50	350x1257x200	90,40
BIL 50/125 kV (50 Hz) - 12,7 kV					
CHV-M 50/12,7	[C] R8D0500012705	50	50	350x615x160	19,70
CHV-M 75/12,7	[C] R8D0750012705	75	50	350x665x160	23,40
CHV-M 100/12,7	[C] R8D1000012705	100	50	350x715x160	26,80
CHV-M 150/12,7	[C] R8D1500012705	150	50	350x765x160	31,20
CHV-M 167/12,7	[C] R8D1670012705	167	50	350x825x160	35,10
CHV-M 200/12,7	[C] R8D2000012705	200	50	350x885x160	39,20
CHV-M 250/12,7	[C] R8D2500012705	250	50	350x995x160	47,00
CHV-M 300/12,7	[C] R8D3000012705	300	50	350x995x160	48,10
CHV-M 333/12,7	[C] R8D3330012705	333	50	350x1055x175	56,90
CHV-M 400/12,7	[C] R8D4000012705	400	50	350x1085x175	59,60
CHV-M 500/12,7	[C] R8D500001270E	500	50	350x1225x175	70,90
CHV-M 600/12,7	[C] R8D600001270E	600	50	350x1375x175	83,00
CHV-M 750/12,7	[C] R8D750001270E	750	50	350x1405x200	98,80
BIL 70/170 kV (50 Hz) - 19,05 kV					
CHV-M 50/19,05	[C] R8E0500019055	50	50	350x644x160	23,30
CHV-M 75/19,05	[C] R8E0750019055	75	50	350x644x160	23,60
CHV-M 100/19,05	[C] R8E1000019055	100	50	350x694x160	27,00
CHV-M 150/19,05	[C] R8E1500019055	150	50	350x804x160	35,00
CHV-M 167/19,05	[C] R8E1670019055	167	50	350x804x160	35,30
CHV-M 200/19,05	[C] R8E2000019055	200	50	350x864x160	39,40
CHV-M 250/19,05	[C] R8E2500019055	250	50	350x964x175	50,80
CHV-M 300/19,05	[C] R8E3000019055	300	50	350x1034x175	56,50
CHV-M 333/19,05	[C] R8E3330019055	333	50	350x1034x175	57,10
CHV-M 400/19,05	[C] R8E4000019055	400	50	350x1134x175	64,40
CHV-M 500/19,05	[C] R8E5000019055	500	50	350x1244x175	73,70
CHV-M 600/19,05	[C] R8E6000019055	600	50	350x1264x200	84,10
CHV-M 750/19,05	[C] R8E7500019055	750	50	350x1454x200	104,20

Codes R8xxxxxxx5 cannot have an internal fuse.



VC Three-phase contactor for MV capacitors

Type	Code	Max. voltage	Max. Current (A)	auxiliary voltage	Size (mm) width x height x depth	weight (kg)
VC-6Z44ED 6,6kV 220V	[*] R80921.	6,6 kVca	3 x 400	220 Vac	353x398.6x247	24,00
VC-6Z44ED 6,6kV 110V	[*] R809210010000	6,6 kVca	3 x 400	110 Vdc	353x398.6x247	24,00



RMV, Choke reactors for MV capacitor banks

Type	Code	In (A)	L (µH)	Size (mm) width x height x depth	weight (kg)
RMV-260					
RMV-260-50-350	[2] R80628.	50	350	370x290x110	12,00
RMV-260-60-250	[2] R80637.	60	250	370x290x110	13,00
RMV-260-100-100	[*] R80664.	100	100	370x290x110	13,00
RMV-260-125-50	[2] R80672.	125	50	370x290x110	14,00
RMV-260-175-30	[2] R80691.	175	30	370x290x110	14,00
RMV-330					
RMV-330-60-450	[2] R80739.	60	450	470x355x110	20,00
RMV-330-75-350	[2] R80748.	75	350	470x355x110	21,00
RMV-330-90-250	[2] R80757.	90	250	470x355x110	26,00
RMV-330-125-100	[2] R80774.	125	100	470x355x110	22,00
RMV-330-200-50	[2] R807A2.	200	50	470x355x110	22,00
RMV-330-250-30	[2] R807B1.	250	30	470x355x110	23,00

Selection parameters for RMV reactances are: * Maximum operating current (1,43 In) * Required inductance in µH * Isolating voltage kV The isolating voltage is 12 kV (28/75). Other voltages on request Thermal current is 43 In / 1 s. Other values on request Other currents and µH please request Price.

Dimensions

CHV-M

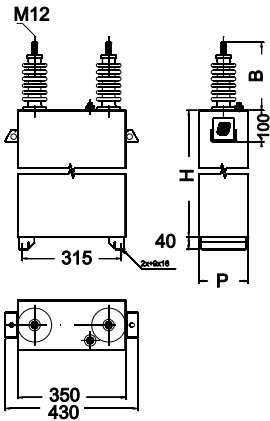

CHV-T

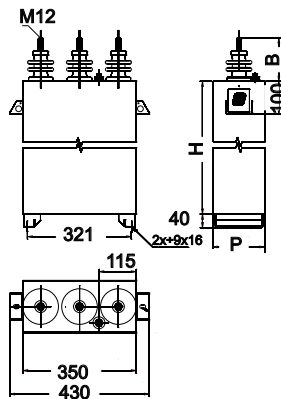

RMV

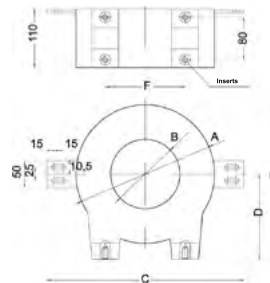

Type	A Ø mm	B Ø mm	C mm	D mm	E mm	F mm	Inserts
RMV-260	260	130	370	160	370	290	M12
RMV-330	330	150	470	190	355	210	M12/M16

MV Automatic capacitor banks

CIRKAP. Easy to choose complete products

Selection of capacitor banks

CIRKAP capacitor banks are divided in two main groups: Capacitor banks in a CM frame and capacitor banks in open BM frames.

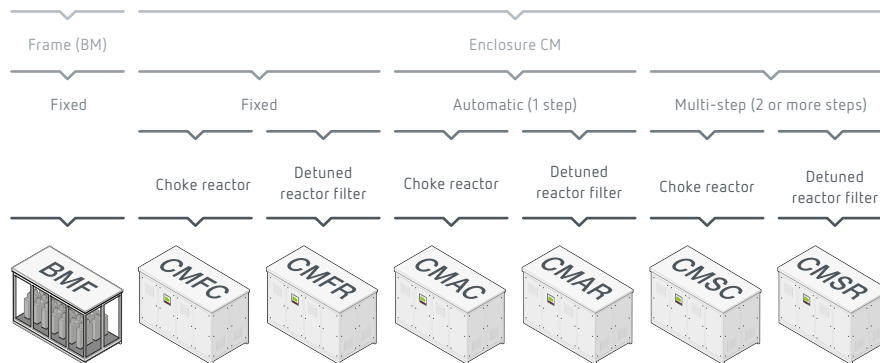

References for CIRKAP BM

Code	B	M	X	X	X	X X X	X X X X X
Fixed (step 1)		F					
Without choke reactor		-					
With choke reactor		C					
Number of steps (1)			n°				
Rated voltage (3 figures) 3.3 kV						033	
Rated voltage (3 figures) 4.2 kV						042	
Rated voltage (3 figures) 5.5 kV						055	
Rated voltage (3 figures) 6.0 kV						060	
Rated voltage (3 figures) 6.3 kV						063	
Rated voltage (3 figures) 6.6 kV						066	
Rated voltage (3 figures) 11 kV						110	
Rated voltage (3 figures) 13.2 kV						132	
Rated voltage (3 figures) 15 kV						150	
Rated voltage (3 figures) 16.5 kV						165	
Rated voltage (3 figures) 22 kV						220	
Rated voltage (3 figures) 33 kV						330	
Nominal capacitor bank power in kvar (5 figures)							n°

References for CIRKAP CM

Code	C	M	X	X	X	X X X	X X X X X
Fixed (step 1)		F					
Automatic (1 step)		A					
Multistep		S					
Without choke reactor		-					
With choke reactor		C					
With detuned filter			R				
Number of steps (1...9)				n°			
Rated voltage (3 figures) 3.3 kV						033	
Rated voltage (3 figures) 4.2 kV						042	
Rated voltage (3 figures) 5.5 kV						055	
Rated voltage (3 figures) 6.0 kV						060	
Rated voltage (3 figures) 6.3 kV						063	
Rated voltage (3 figures) 6.6 kV						066	
Rated voltage (3 figures) 11 kV						110	
Rated voltage (3 figures) 13.2 kV						132	
Rated voltage (3 figures) 15 kV						150	
Rated voltage (3 figures) 16.5 kV						165	
Rated voltage (3 figures) 22 kV						220	
Rated voltage (3 figures) 33 kV						330	
Nominal capacitor bank power in kvar (5 figures)							n°

Application examples



Water treatment installation

Automatic multi-step capacitor bank with detuned filter, model CMSR, 2250 kvar at 6,6 kV, 50 Hz, 5x650 kvar composition, tuned to 189 Hz (p:7%), outdoor installation and IP44 protection degree. Details of the step with fuse protection, vacuum contactor, filtering reactor and three-phase capacitor.



Paper industry

Automatic multi-step capacitor bank with detuned filter, model CMSR, 6750 kvar at 22 kV, 50 Hz, 750+4x1500 kvar composition, tuned to 189 Hz (p:7%), outdoor installation and IP54 protection degree. Voltage presence indicator, ON/OFF step, manual or automatic step selection, reactive energy regulator with three-phase measurement and overcurrent, short-circuit and step offset protection relays.



Road infrastructures

Automatic multi-step capacitor banks with detuned filter, model CMAR, 100 kvar at 3.3 kV, 50 Hz, 1x100 kvar composition, indoor installation and IP23 protection degree, tuned to 189 Hz. Details of the structure adapted to the space available in the tunnel and corporate colour requested by the client.

Additional components of MV capacitor banks



Pressure switch

Disconnects the step/capacitor bank with the pressure generated after a serious fault inside a capacitor, in order to prevent greater damage. It enables the power circuit to be disconnected and signals the fault when the pressure reaches the maximum value.



Voltage presence indicator

A unit that lights up permanently when the power circuit is powered to provide greater safety during operations carried out on the unit.



Smoke detector

Smoke detectors are devices that warn about the possibility of internal combustion in the capacitor bank and that send a signal to activate an alarm (in the unit or at the discretion of the user), disconnecting the of the battery if necessary.



Electric circuit with opening delay for doors

For units that are ordered with doors in the power modules, Circutor offers the possibility of including a solenoid electrical interlock system in order to prevent access to the capacitor bank's interior if the necessary time has not elapsed.

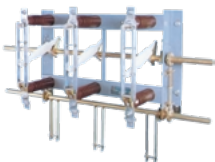

SVacuum off-load and/or earthing switch

The cut-off and/or earthing switch enables the unit to be visually disconnected and isolated at the capacitor bank input.



Ventilation

In the case of capacitor banks installed in environmental conditions where natural convection cooling is insufficient, an auxiliary thermostat-controlled forced air system is essential for evacuating the internal heat of the capacitor bank.



Anti-condensation heating resistors

These are used to avoid condensation due to temperature gradients during the day, under saline environmental conditions, high relative humidity and low temperatures. Heating resistors controlled by thermostat and/or hygrometer.

Step dimensions

Power	7,2 kV	12 kV	24 kV	36 kV
≤250 kvar	A	A	B	C
21-500 kvar	A	A	B	C
501-750 kvar	A	B	B	C
751-1000 kvar	A, B	B	B	C
1001-1500 kvar	B	B	C	C
1501-2000 kvar	B	B	C	C
201-2500 kvar	B	B	C	C
2501-3000 kvar	B	C	C	C
3001-4000 kvar	C	C	C	C
4001-5000 kvar	C	C	C	
5001-6000 kvar	C	C	C	
6001-7000 kvar	C	C	C	

Dimensions are approximate and may differ depending on the specifications for each team.

INDOOR

OUTDOOR

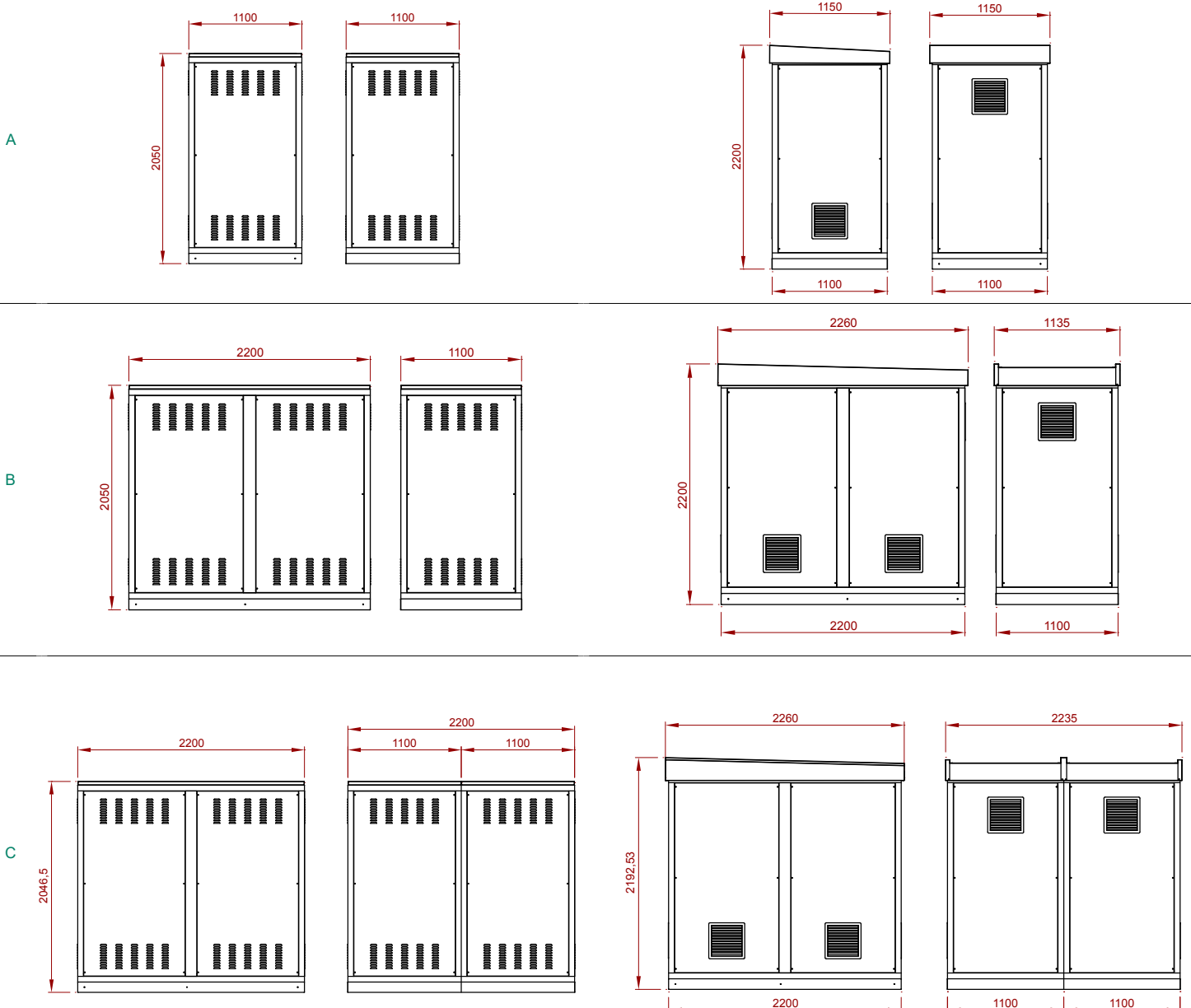

Management software



PowerStudio Universe, Energy management software

- Real-time monitoring
- Intuitive visualisation and navigation via Wave
- Efficient control via SCADA screens
- Process automation
- Incident management
- All alarms under control
- Automatic and scheduled reports
- Communication with any Modbus equipment
- Instant export to SQL database
- XML API for data extraction

Type	Code	Description
SCADA software		
PowerStudio SCADA Basic	[*] W20100.	SCADA software for monitoring, control and analysis of installations, with CIRCUTOR devices and third-party Modbus equipment. Up to 25 devices
PowerStudio SCADA Pro	[*] W20110.	SCADA software for monitoring, control and analysis of installations, with CIRCUTOR devices and third-party Modbus equipment. Up to 50 devices
PowerStudio SCADA Ultimate	[*] W20120.	SCADA software for monitoring, control and analysis of installations, with CIRCUTOR devices and third-party Modbus equipment. Up to 500 devices.
PowerStudio SCADA Enterprise	[*] W20130.	SCADA software for monitoring, control and analysis of installations, with CIRCUTOR devices and third-party Modbus equipment. More than 500 devices.
OPC UA Server	[*] W20200.	Allows to configure an OPC UA server in PowerStudio for any SCADA with OPC UA client to integrate the desired parameters.
PS-DataBox	[*] W20300.	Connects PowerStudio software and DataBox cloud platform

NEW



Scout, Cloud-Scout software

Cloud-Scout Electrical monitoring and auditing software

Type	Code	Description
Quality Analyst_Scout	[*] W10320.	Module for the analysis and monitoring of power quality
DSO Monitor_Scout	[*] W10330.	Module for monitoring and operation of transformer substations
VAR_Scout	[*] W10340.	Module for battery performance and power factor monitoring

Module prices are annual subscription prices per connected device.

Equipment compatible with the modules:

Quality Analyst: QNA 600.

VAR: computer C Wi-Fi, computer SMART III connected with SmartLink-VAR converter.

DSO Monitor: R-SABT.



DATABOX, DataBox Cloud software

DataBox is an Industrial IoT platform for monitoring, control and analysis for facility management:

- Monitored variables
- Calculation of KPIs based on measured variables
- Alarm service. Generation, Warning, and Tracking
- Automatic Reporting
- Remote and local control and management of actions
- Visualization and control of parameters via widgets and dashboards
- Parameter comparisons over time or between installations
- SCADA synoptic screen which allows you to view a photograph or diagram and attach variables and links to widgets, dashboards, etc.
- Platform Customization/Branding (Name, DNS, and Background Image)

Type	Code	Description
Plan		
LitePlan_Databox	[*] W10100.	6 Readings, 6 Alarms and 6 Actuators
SmallPlan_Databox	[*] W10101.	18 Readings, 18 Alarms and 18 Actuators
MediumPlan_Databox	[*] W10102.	55 Readings, 55 Alarms and 55 Actuators
BigPlan_Databox	[*] W10103.	100 Readings, 100 Alarms and 100 Actuators
User		
BasicUser_Databox	[*] W10110.	Viewing permissions
AdvancedUser_Databox	[*] W10111.	Viewing and editing permissions for graphical configuration and reports
AnalyticsUser_Databox	[*] W10112.	Permissions to view, analyse and edit graphical configuration and reports.
ProfessionalUser_Databox	[*] W10113.	Administrator permissions. A minimum of one user per partner is required
Service		
Act-Firmware_Databox	[*] W10120.	ePick GPRS VPN over-the-air firmware upgrade
ImportVar_Databox	[*] W10121.	Variable imported and stored in the platform
ModbusIntegration_Databox	[*] W10122.	Integration of a Modbus map of a new device
Brand_databox	[*] W10123.	Visual customisation of the platform (Name, DNS and background image)
API_Databox	[*] W10124.	Extensive use of the API. 1,000 first calls free of charge. Monthly charging of 25.000 calls packages.

All codes, with the exception of W10120, W10122, and W10124, correspond to monthly subscription prices. The prices for codes W10120, W10122, are one-time purchase prices. The price of code W10124, corresponds to 25,000 calls. A reading is understood as a variable that is periodically recorded, an alarm as an expression that is continuously evaluated locally and reported, and an actuator as a pre-configured (manual or programmed) remote control action.



ePick Gateway for DataBox platform

Type	Code	Description
ePick GPRS VPN	[*] D60060.	Gateway with GPRS communications via VPN network and SIM card with worldwide coverage fully configured to send data from the units connected to the RS-485 port or Ethernet to the Databox cloud platform.
ePick GPRS NET	[*] D60070.	Gateway with GPRS communications (SIM card must be provided by the user) to send data from the units connected to the RS-485 port or Ethernet to the Databox cloud platform in order to carry out energy audits and improvements related to Electrical Energy Efficiency

Accessories

Antena mural	[C] Q4994M.	Indoor wall antenna 2.2 dBi 2m
Antena antivandálica	[C] Q4994N.	Antenna antivandalic IP67 4dBi 1m



PowerVision, Data management software for devices with memory

PowerVision, data management software for portable devices with memory

Type	Code	Description
Data management software		
PowerVisionPlus	[*] M90413.	Software for reading, downloading and processing files for devices equipped with memories (depending on type). Elaboration of graphs and tables from information. Automatic downloading for QNA Power Quality Analyzers. Other related units: AR5, AR5-L, QNA, CLP, CVM-BD M, CIR-E3 and AR6 series